

---

ABB MEASUREMENT & ANALYTICS | DATA SHEET

## **TBX5**

pH, Redox (ORP) sensors  
with diagnostics

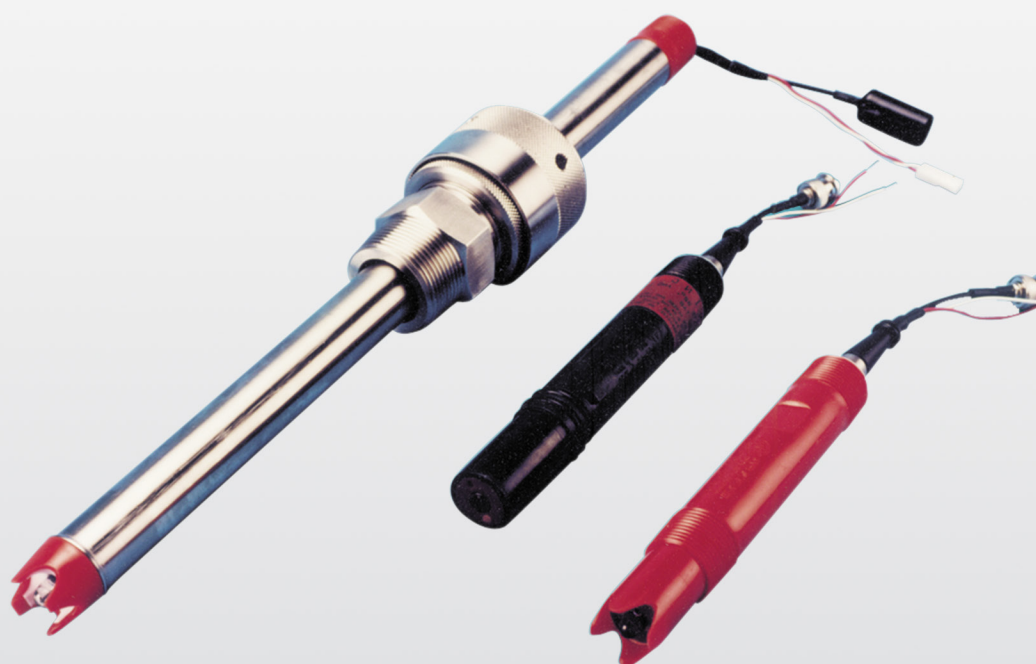

---

## Measurement made easy

The most durable pH / Redox (ORP) sensors in the world

### **Next Step™ Solid State reference**

- eliminates poisoning, pumping and plugging

### **Advantage™ series with solution ground rod**

- permits continuous sensor diagnostics

### **Comprehensive selection of measuring electrodes**

- sensors designed to suit all application requirements

### **Combination style construction**

- measuring, reference and temperature elements, all in one compact body

### **Insertion, submersion, flow-through and hot-tap**

- increases flexibility of installation

### **Operating temperatures up to 140 °C (284 °F)**

- the highest glass temperature limit on the market

### **Operating pressures up to 21 bar (300 psi) and higher**

- the highest pressure limit on the market

## The most durable pH / Redox (ORP) sensors in the world

A well-deserved reputation for ruggedness, longevity and accuracy hallmark the TB(X)5 series pH / Redox sensors. The sensors are easily applied to most industrial measurement needs. They are renowned for their ability to outperform conventional sensors in the industries' toughest process applications.

Solid-state Next Step reference technology is the foundation for all TB(X)5 series electrodes. The totally solid inner reference chamber is charged with potassium chloride (KCl). This non-liquid reference all but eliminates poisoning, plugging and pumping problems that plague conventional liquid, slurry and gel designs.

The Next Step Advantage series incorporates a solution ground rod that enables sensor diagnostics.

All measurement functions are combined in one compact body: reference, measuring electrode, temperature sensor and ground rod. Using an integral potted cable, a completely sealed assembly is provided without in-process high impedance connections.

These advances in reference design, combined with superior glass electrode technology, result in an industrial sensor with unequalled durability and flexibility

## Wide variety of sensors for most industrial applications

ABB offers a wide variety of standard sensors for most applications. These include variations in body style, measuring electrode type and shape, temperature compensator, junction type and shape and cable. Next Step Advantage sensors also allow choice of solution ground and O-ring materials.

## Durable electrodes

The TB(X)5 electrode design eliminates failures due to thermal stress caused by rapid temperature excursions. Unlike other sensors that use a large inner air bubble for expansion absorption, TB(X)5 electrodes use a unique inner plunger; providing more effective protection against temperature fluctuations.

The glass contains no barium, cobalt or uranium oxides. The impedance is low enough to maintain signal integrity, yet high enough to remain chemically durable with little or no sodium ion (Na<sup>+</sup>) error.

The electrodes are available in several measuring element types ensuring greatest process optimization.



ABB TB(X)5 series sensor construction

## Electrode types and ratings

Code	Type	Description	Range	Operating temperatures		Ratings
				°C	°F	Impedance at 25 °C (77 °F)
1	Flat glass	High density duty with heavy fouling. Electrode flush with liquid junction. Low Na <sup>+</sup> error.	0 to 14 pH	10 to 100	60 to 212 <sup>1</sup>	650 MΩ
2	General-purpose glass	For light to medium duty and lower temperature applications. Not for high pH.	0 to 12 pH	0 to 100	32 to 212	200 MΩ
3	High temperature glass	Versatile and suitable for high and low pH, strong chemicals and high temperature rated cabling.	0 to 14 pH	10 to 140	50 to 284	500 MΩ
5	Redox (ORP)	Platinum (Pt) element.	0 to ±2000 mV	0 to 140	32 to 284	1 kΩ
A	Redox (ORP)	Gold (Au) element.	0 to ±2000 mV	0 to 140	32 to 284	1 kΩ
F	Fluoride / Acid	Resistant to etching by up to several percent HF and strong acids.	0 to 12 pH	10 to 80 <sup>2</sup>	50 to 176 <sup>2</sup>	500 MΩ
J	Coating resistant high temperature	Versatile and suitable for high and low pH, strong chemicals.	0 to 14 pH	10 to 140	50 to 284	500 MΩ

Notes. <sup>1</sup> 0 to 121 °C (32 to 250 °F) for sterilization cycles

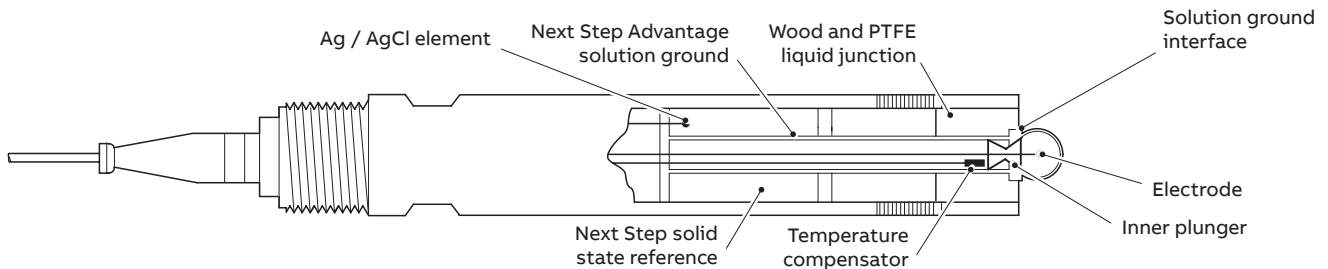
<sup>2</sup> 50 °C (122 °F) maximum recommended for high HF concentration

## Body style

Sensor bodies are constructed of Kynar (PVDF) or Ryton (PPS). TB5 series sensors use Solid-State Next Step references. The TBX5 series denotes Next Step Advantage types with integral solution ground.

Model number			
Solid-state Next Step	Next Step Advantage	Body	Application
TB551	TBX551	PPS	In-line, twist-lock, submersion
TB556	TBX556	PVDF	In-line, threaded, submersion
TB557	TBX557	PVDF	Ball valve retractor, hot-tap
TB561	TBX561	PVDF	In-line, sterilizable
TB564	TBX564	PVDF	High pressure retractor, hot-tap
TB567	TBX567	PPS	In-line, high pressure

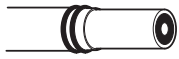

**pH**  
Type 1 – flat glass

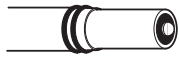

**pH**  
Type 2 – general purpose glass  
Type 3 – high temperature glass  
Type f – fluoride / acid resistant glass  
Type j – coating resistant glass

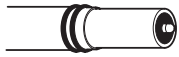

**ORP**  
Type 5 – platinum  
Type A – gold

Electrode types

To promote TB(X)5 electrode process efficiency, reference junctions are available as either wood or PTFE, each also offered in flush or notched forms.

The hardwood junction is recommended for all general purpose duties particularly those requiring high resistance to coating. PTFE junctions are promoted for continuous processes over 11.0 pH or those containing known wood delignifiers such as strong caustics, bleaches and other oxidizers.

Flush junctions have no process protrusions and therefore supply excellent self-cleaning properties when used with flat glass and fitted at 90 ° in process pipelines.

Notched junctions provide an integral protection guard for normal bulb-style glasses and are especially suited for retractable and immersion sensors.

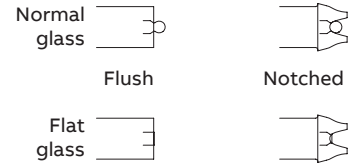

Junction styles

## Sensor models and applications

### Junction styles

Style	Description	Application
Flush	Flush with end of sensor	In-line, heavy fouling processes
Notched	Extends beyond junction providing electrode protection	Hot-tap (ball valve) and immersion sensors

### Reference junction selection

Sensor TB(X)	Flush			Notched		
	Wood	PTFE	Electrodes	Wood	PTFE	Electrodes
551	✓	✓	1, 2, 3, 5, A, F, J	✗	✗	✗
556	✓	✓	1, 2, 3, 5, A, F, J	✓	✓	1, 2, 3, 5, A, F, J
557	✓	✓	1	✓	✓	1, 2, 3, 5, A, F, J
561	✓	✓	1, 2, 3, 5, A, F, J	✓	✓	1, 2, 3, 5, A, F, J
564	✓	✓	1, 2, 3, 5, A, F, J	✓	✓	1, 2, 3, 5, A, F, J
567	✓	✓	2, 3, 5, A, F, J	✗	✗	✗

**Note.** ✓ = Valid selection ✗ = Invalid selection

## Temperature compensation

Temperature compensators enable analyzers to adjust for temperature effects on the glass pH electrode output (Nernst). Selected analyzers can also use this measurement to compensate for solution pH temperature effects.

Sensors can be ordered with integral temperature sensors or as external units.

The integral temperature compensator is available in two forms; Balco 3k and Pt100.

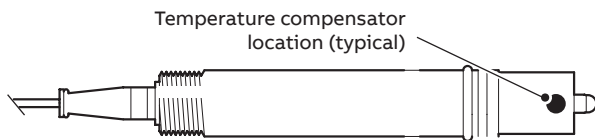

Integral temperature compensator

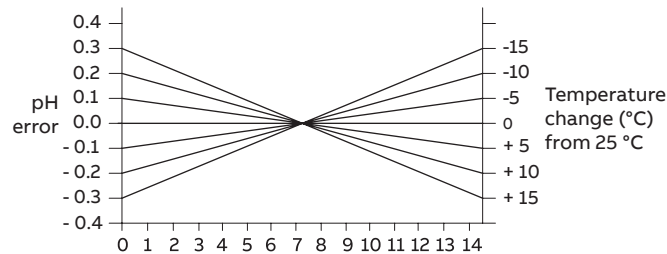

pH Error without temperature compensation

## Cable options

TB(X)5 sensors offer complete flexibility of cabling options throughout the range. All cables are potted inside the sensor ensuring environmental protection.

The standard cable length for most sensors is 1.5 m (5 ft.). However, cables can be supplied as any continuous size up to 9 m (30 ft.).

Standard accessories include junction boxes and submersion (immersion) couplers, typically used with extension cables for direct connection to ABB-TBI instruments.

Extension cables also permit distances between sensor and instrument of up to 30 m (100 ft.) without external preamplifier.

A BNC / TC to pin terminal adapter is available for connection to TB82, TB84, 4630 and AX46 series instruments.

Sensors with pin terminals are selected with code option 'T'

## Next Step Advantage sensor cables and junction box wiring (TBX5 sensors)

### ORP / Redox sensors without temperature compensator

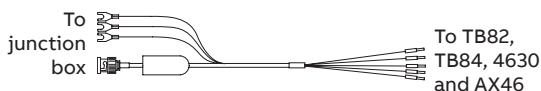
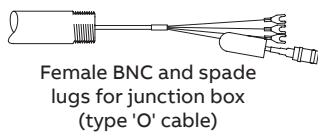
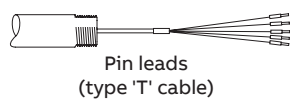

Male BNC / spade lug to pin leads extension (cable 4TB 3011-7XXX)

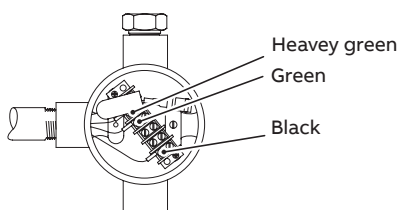

Junction box wiring (4TB5023-0088)

### pH sensors with temperature compensator

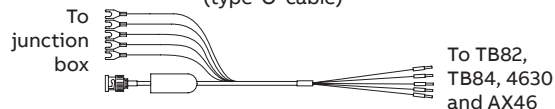
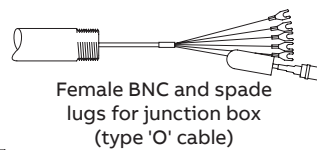
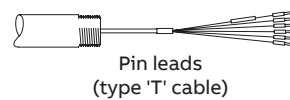

Male BNC / spade lug to pin leads extension (cable 4TB 3011-7XXX)

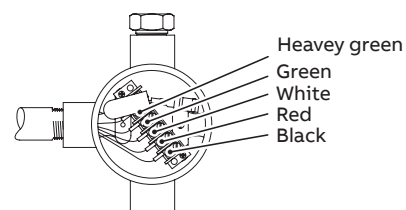

Junction box wiring (4TB5023-0088)

## Solid state and Next Step reference sensor cables and junction box wiring (TB5 models)

### ORP / Redox sensors without temperature compensator

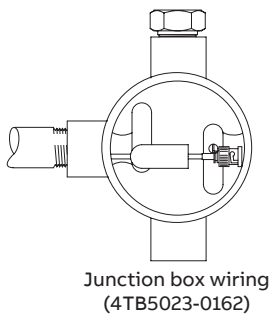
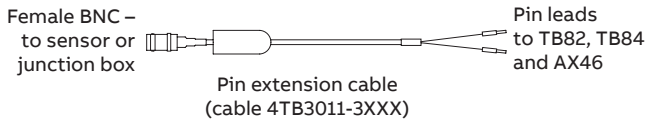
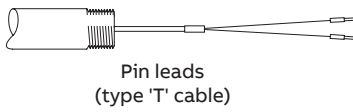
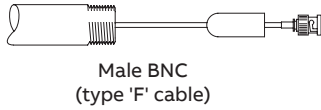

### pH sensors with temperature compensator

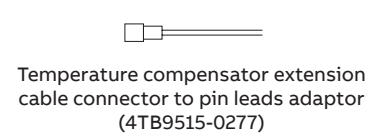
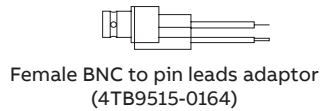
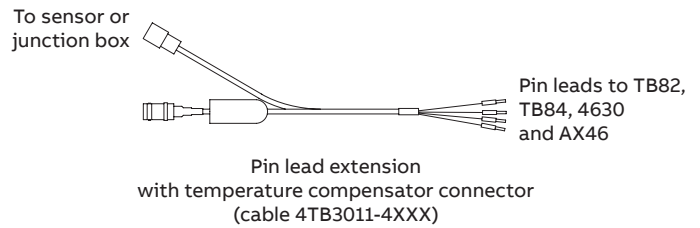
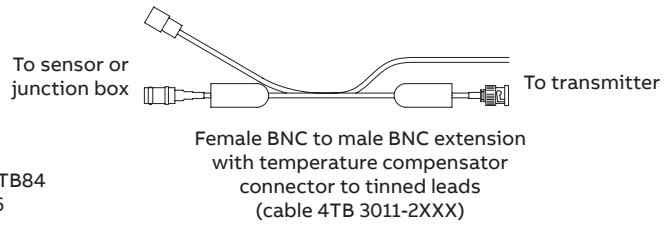
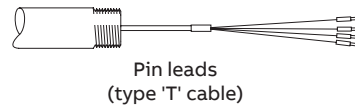
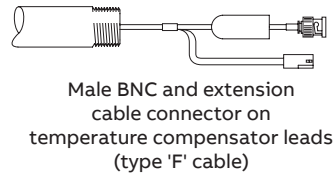
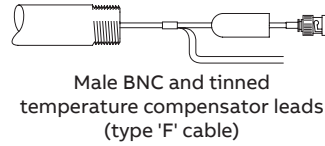

**Note.** Junction box not supplied with cable gland kit (part number: 4TB9515-0244)

## TB551 and TBX551 Ryton sensors

TB(X)551 sensors are in-line flow-through or submersible (immersion), general purpose, twist-lock style sensors. The sensor body is molded from chemically resistant Ryton® (PPS).

The sensor can be adapted to 1 in. fittings by either a threaded Ryton receptacle or a twist-lock receptacle. The twist-lock receptacle is available in Kynar® (PVDF) or stainless steel.

Optional electrode guards protect the electrode in submersion (immersion) applications.



TB(X)551 Ryton sensors

## Specification

### Applications

In-line, flow-through, submersible (immersion)

### Maximum pressure / temperature

690 kPa (100 psi) at 140 °C (284 °F)

### Features

Low cost, universal type.

Adapter for twist-lock, or threaded-cap, insertion

### Material

Body	Ryton (polyphenylene sulphide)
Junction	Wood or PTFE
Junction types	Flush

## Overall dimensions – TB(X)551

Dimensions in mm (in.)

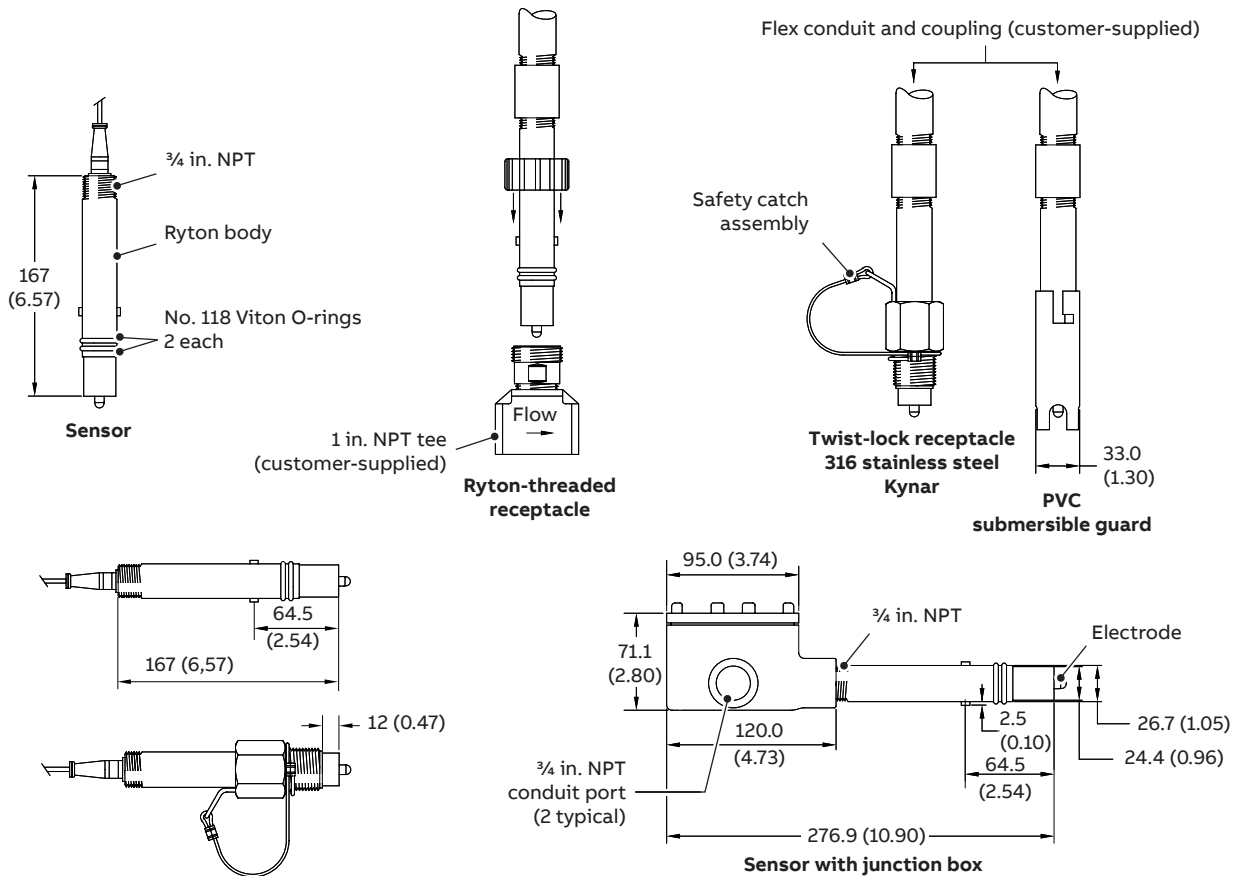

## Ordering information – TB551

Standard solid-state sensors – no solution ground rod	TB551	X	X	X	X	X	X	X	X
<b>Next Step in-line, twist-lock, immersion (submersible) Ryton body pH / ORP sensor assembly (690 kPa [100 psi] at 140 °C [284 °F])</b>									
<b>Measuring electrode</b>									
Flat glass (10 to 100 °C, 0 to 14 pH) for high particulates with flow at 90 °		1							
Glass, pH (0 to 100 °C, 0 to 12 pH)		2							
High temperature glass (5 to 140 °C, 0 to 14 pH)		3							
Platinum, Redox (ORP)		5							
Gold, Redox (ORP)		A							
Glass, pH, fluoride-resistant (10 to 80 °C, 0 to 12 pH)		F							
Coat-resistant glass / high temperature (5 to 140 °C, 0 to 14 pH)		J							
<b>Integral thermocompensation</b>									
None		0							
3 kΩ Tinned leads <sup>2</sup>		1							
3 kΩ Extension cable connector <sup>2</sup>		2							
Pt100 Tinned leads <sup>2,3</sup>		3							
Pt100 Extension cable connector <sup>2,3</sup>		4							
<b>Liquid junction</b>									
Wood, flush							1		
PTFE, flush							3		
PTFE, recessed							4		
Wood, flush, Next Step reference							A		
PTFE, flush, Next Step reference							B		
<b>Solution ground rod material</b>							N/A		
<b>O-ring material</b>							N/A		
<b>Body style</b>									
Ryton body								0	
<b>Accessory hardware</b>									
None								0	
Stainless steel, twist-lock receptacle (4TB5205-0118)								2	
Kynar (PVDF), twist-lock receptacle (4TB5205-0119)								3	
PVC, submersible guard (4TB5205-0120)								4	
Ryton (PPS), threaded receptacle (4TB9515-0120)								6	
<b>Units of measure, integral sensor cable <sup>5</sup></b>									
BNC connector, feet									F
Tinned / Pin leads, feet <sup>1</sup>									T
Use when JB (below) is selected <sup>6,7</sup>									0
<b>Length, integral sensor cable</b>									
1 ft. (0.3 m) 30 ft. (8.8 m) enter length (in 5 ft. increments) (available in increments of 5 in. (12.7 cm) to 30 in. (76.2 cm).)									--
With junction box <sup>6,7</sup>									J B
Less junction box <sup>6,7</sup>									J S

### Notes.

- For direct connection to APA592, TB82, TB84, 4630 / 35 and AX46 transmitters or other supplier devices, using terminal blocks.
- Not available for Redox (ORP) electrodes (codes 5 & A).
- Not available for fluoride-resistant electrodes (code F). Compatible with APA592, TB82, TB84, 4630 / 35 and AX46 instruments.
- Kalrez® O-rings only for solution ground sleeve. External O-rings are Viton.
- There are two options to connect to a transmitter using terminal blocks:
  - Option 1 – use BNC / TC to PIN adapter with conduit fitting or BNC / TC to PIN adapter. In either case temperature compensator code must be 2 or 4.
  - Option 2 – select T in integral cable code, not designed for use with extension cables or junction box.
- TB551: junction box mounted on sensor. Cable length approximately 102 mm (4 in.). Requires extension cable.
- TB(X)551: when selecting JB or JS, cable length is approximately 102 mm (4 in.). Requires extension cable. If junction box is ordered separately and longer cable lengths are required, enter length under code for integral cable.



## Ordering information – TBX551

Sensors for self-checking – with solution ground rod	TBX551	X	X	X	X	X	X	X	X	X	X
<b>Next Step Advantage, in-line, twist-lock, submersible (immersion) <sup>1</sup> Ryton body pH / ORP sensor assembly (690 kPa [100 psi] at 140 °C [284 °F])</b>											
<b>Measuring electrode</b>											
Flat glass (10 to 100 °C, 0 to 14 pH) for high particulates with flow at 90 °	1										
Glass, pH (0 to 100 °C, 0 to 12 pH)	2										
High temperature glass (5 to 140 °C, 0 to 14 pH)	3										
Platinum, Redox (ORP)	5										
Gold, Redox (ORP)	A										
Glass, pH, fluoride-resistant (10 to 80 °C, 0 to 12 pH)	F										
Coat-resistant glass / high temperature (5 to 140 °C, 0 to 14 pH)	J										
<b>Integral thermocompensation</b>											
None		0									
3kΩ Tinned leads <sup>2</sup>		1									
Pt100 Tinned leads <sup>2,3</sup>		3									
<b>Liquid junction</b>											
Wood, flush				1							
PTFE, flush				3							
Wood, flush, Next Step reference				A							
PTFE, flush, Next Step reference				B							
<b>Solution ground rod material</b>											
316 stainless steel					1						
Titanium					2						
Hastelloy® B2					3						
<b>O-ring material</b>											
Viton						1					
EPDM						2					
Silicone						3					
Kalrez						4					
<b>Body style</b>											
Ryton body								0			
<b>Accessory hardware</b>											
None										0	
Stainless steel, twist-lock receptacle (4TB5205-0118)										2	
Kynar (PVDF), twist-lock receptacle (4TB5205-0119)										3	
PVC, submersible guard (4TB5205-0120)										4	
Ryton (PPS), threaded receptacle (4TB9515-0120)										6	
<b>Units of measure, integral sensor cable <sup>5</sup></b>											
Tinned / Pin leads, feet <sup>1</sup>											T
Use when JB (below) is selected <sup>6,7</sup>											0
<b>Length, integral sensor cable</b>											
1 ft. (0.3m) 30 ft. (8.8 m) enter length (in 5 ft. increments) (available in increments of 5 in. (12.7 cm) to 30 in. (76.2 cm).											--
With junction box <sup>6,7</sup>											J B
Less junction box <sup>6,7</sup>											J S

### Notes.

- For direct connection to APA592, TB82, TB84, 4630 / 35 and AX46 transmitters or other supplier devices, using terminal blocks.
- Not available for Redox (ORP) electrodes (codes 5 & A).
- Not available for fluoride-resistant electrodes (code F). Compatible with APA592, TB82, TB84, 4630 / 35 and AX46 instruments.
- Kalrez O-rings only for solution ground sleeve. External O-rings are Viton.
- There are two options to connect to a transmitter using terminal blocks:
  - Option 1 – use BNC / TC to PIN adapter with conduit fitting or BNC / TC to PIN adapter. In either case temperature compensator code must be 2 or 4.
  - Option 2 – select T in integral cable code, not designed for use with extension cables or junction box.
- TB551: junction box mounted on sensor. Cable length approximately 102 mm (4 in.). Requires extension cable.
- TB(X)551: when selecting JB or JS, cable length is approximately 102 mm (4 in.). Requires extension cable. If junction box is ordered separately and longer cable lengths are required, enter length under code for integral cable.

## TB556 & TBX556 Kynar sensors

TB(X)556 sensors are threaded style sensors suitable for submersion (immersion) and insertion into the process pipes.

Mounting thread size is ¾ in. NPT.

The sensor is available in several insertion lengths from the standard 40 mm (1.5 in.) to a maximum of 127 mm (5 in.). The sensor body is molded from chemically resistant Kynar (PVDF).



TB(X)556 Kynar sensors

## Specification

### Applications

¾ in. NPT process connection,  
in-line, submersion (immersion)

### Maximum pressure / temperature

690 kPa (100 psi) at 80 °C (176 °F)  
276 kPa (40 psi) at 140 °C (284 °F)

### Material

Body	Kynar (PVDF) as standard
Junction	Wood or PTFE
Junction types	Flush Notched

### Flow-through

Specify insertion depth in code

### Submersion / Immersion

With notched junction

## Overall dimensions – TB(X)556

Dimensions in mm (in.)

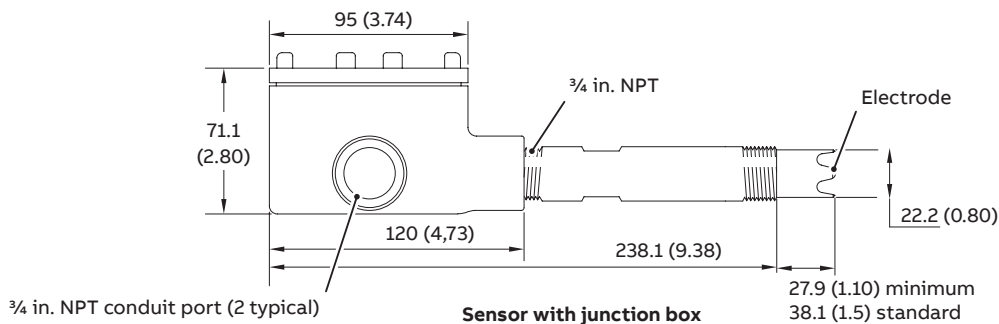
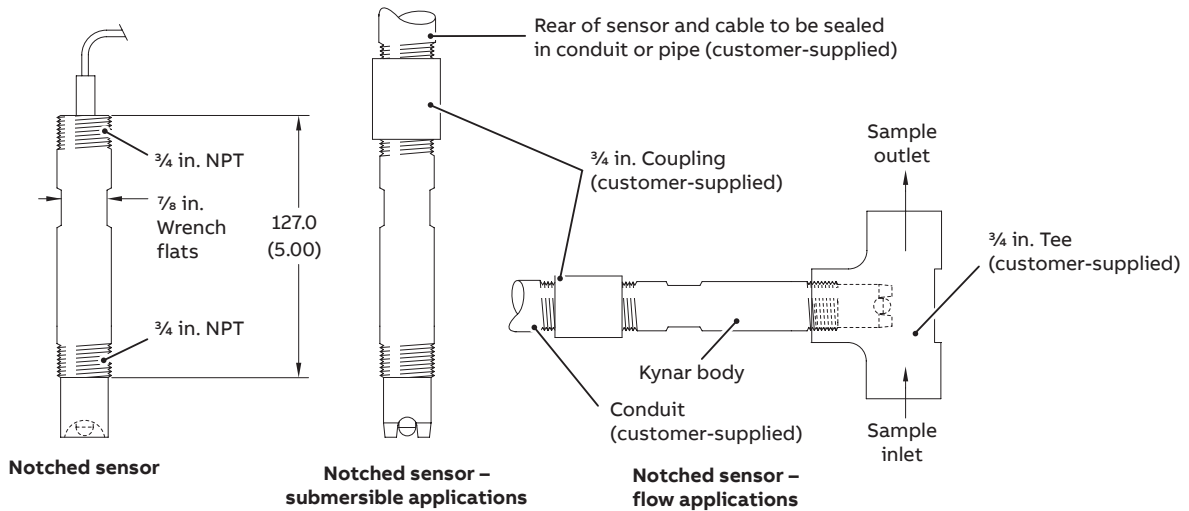

As specified up to 127.0 (5.00) maximum (see **Note**)

**Note.** 27.9 mm (1.1 in.) insertion depth not available on TBX Advantage sensors with solution grounds.

## Ordering information – TB556

Standard solid-state sensors – no solution ground rod	TB556	X	X	X	X X	X	X X
<b>Next Step in-line, threaded, submersible (immersion), Kynar body pH / ORP sensor assembly (276 kPa [40 psi] at 140 °C [284°F] / 690 kPa [100 psi] at 90 °C [194 °F])</b>							
<b>Measuring electrode</b>							
Flat glass (10 to 100 °C, 0 to 14 pH) for high particulates with flow at 90 °		1					
Glass, pH (0 to 100 °C, 0 to 12 pH)		2					
High temperature glass (5 to 140 °C, 0 to 14 pH)		3					
Platinum, Redox (ORP)		5					
Gold, Redox (ORP)		A					
Glass, pH, fluoride-resistant (10 to 80 °C, 0 to 12 pH)		F					
Coat-resistant glass / high temperature (5 to 140 °C, 0 to 14 pH)		J					
<b>Integral thermocompensation</b>							
None			0				
3kΩ Tinned leads <sup>1</sup>			1				
3kΩ Extension cable connector <sup>1</sup>			2				
Pt100 Tinned leads <sup>1,2</sup>			3				
Pt100 Extension cable connector <sup>1,2</sup>			4				
<b>Liquid junction</b>							
Wood, flush				1			
PTFE, flush				3			
Wood, notched				5			
PTFE, notched				6			
Wood, flush, Next Step reference				A			
PTFE, flush, Next Step reference				B			
Wood, notched, Next Step reference				D			
PTFE, notched, Next Step reference				E			
<b>Solution ground rod material</b>					N/A		
<b>O-ring material</b>					N/A		
<b>Body style</b>							
Submersible (Immersion) probe <sup>5</sup>						0 0	
0.8 in. insertion depth <sup>3</sup>						0 8	
1.1 in. insertion depth						1 1	
1.5 in. insertion depth						1 5	
2.0 in. insertion depth						2 0	
2.5 in. insertion depth						2 5	
3.0 in. insertion depth						3 0	
3.5 in. insertion depth						3 5	
4.0 in. insertion depth						4 0	
4.5 in. insertion depth						4 5	
5.0 in. insertion depth <sup>4</sup>						5 0	
<b>Integral sensor cable <sup>6</sup></b>							
BNC connector, feet							F
Tinned / Pin leads, feet <sup>7</sup>							T
Use when JB (below) is selected <sup>8,9</sup>							O
<b>Length, integral sensor cable</b>							
1 ft. (0.3 m) 30 ft. (8.8 m) enter length (in 5 ft. increments)							--
With junction box <sup>8,9</sup>							J B
Less junction box <sup>8,9</sup>							J S

### Notes.

- Not available for Redox (ORP) electrodes (codes 5 & A).
- Not available for fluoride-resistant electrodes (code F). Compatible with TB82, APA592, TB84, 4630 / 35 and AX46 instruments.
- 0.8 in. insertion option not available with liquid junction options D & E.
- 5.0 in. insertion option not available with liquid junction options 1, 3, A, B.
- Manufactured as 1.5 in. depth, includes cable strain relief.
- There are two options to connect to a transmitter using terminal blocks:
  - Option 1 – use BNC / TC to PIN adapter with conduit fitting or BNC / TC to PIN adapter. In either case temperature compensator code must be 2 or 4.
  - Option 2 – select T in integral cable code, not designed for use with extension cables or junction box.
- For direct connection to type TB82, APA592, TB84, 4630 / 35 and AX46 transmitters, or other supplier devices, using terminal blocks.
- TB556: junction box or submersible (immersion) connector mounted on sensor. Cable length approximately 102 mm (4 in.). Requires extension cable for temperature compensator code must be 0, 2 or 4.
- TB(X)556: junction box mounted on sensor. Cable length approximately 102 mm (4 in.). Requires extension cable for connection to transmitter. If junction box is ordered separately and longer cable lengths are required, enter cable length in code for integral cable.

## Ordering information – TBX556

Sensors for self-checking –with solution ground rod	TBX556	X	X	X	X	X	X	X	X	X
<b>Next Step Advantage, in-line, threaded, submersible (immersion), Kynar body pH / ORP sensor assembly (276 kPa [40 psi] at 140 °C [284°F] / 690 kPa [100 psi] at 90 °C [194 °F])</b>										
<b>Measuring electrode</b>										
Flat glass (10 to 100 °C, 0 to 14 pH) for high particulates with flow at 90 °		1								
Glass, pH (0 to 100 °C, 0 to 12 pH)		2								
High temperature glass (5 to 140 °C, 0 to 14 pH)		3								
Platinum, Redox (ORP)		5								
Gold, Redox (ORP)		A								
Glass, pH, fluoride-resistant (10 to 80 °C, 0 to 12 pH)		F								
Coat-resistant glass / high temperature (5 to 140 °C, 0 to 14 pH)		J								
<b>Integral thermocompensation</b>										
None			0							
3kΩ Tinned leads <sup>1</sup>			1							
Pt100 Tinned leads <sup>1,2</sup>			3							
<b>Liquid junction</b>										
Wood, flush				1						
PTFE, flush				3						
Wood, notched				5						
PTFE, notched				6						
Wood, flush, Next Step reference				A						
PTFE, flush, Next Step reference				B						
Wood, notched, Next Step reference				D						
PTFE, notched, Next Step reference				E						
<b>Solution ground rod material</b>										
316 stainless steel					1					
Titanium					2					
Hastelloy® B2					3					
<b>O-ring material</b>										
Viton						1				
EPDM						2				
Silicone						3				
Kalrez						4				
<b>Body style</b>										
Submersible (Immersion) probe <sup>5</sup>								0	0	
1.5 in. insertion depth								1	5	
2.0 in. insertion depth								2	0	
2.5 in. insertion depth								2	5	
3.0 in. insertion depth								3	0	
3.5 in. insertion depth								3	5	
4.0 in. insertion depth								4	0	
4.5 in. insertion depth								4	5	
5.0 in. insertion depth <sup>4</sup>								5	0	
<b>Integral sensor cable <sup>6</sup></b>										
Tinned / Pin leads, feet <sup>7</sup>										T
Use when JB (below) is selected <sup>8,9</sup>										0
<b>Length, integral sensor cable</b>										
1 ft. (0.3 m) 30 ft. (8.8 m) enter length (in 5 ft. increments)										--
With junction box <sup>8,9</sup>										J B
Less junction box <sup>8,9</sup>										J S

### Notes.

- Not available for Redox (ORP) electrodes (codes 5 & A).
- Not available for fluoride-resistant electrodes (code F). Compatible with TB82, APA592, TB84, 4630 / 35 and AX46 instruments.
- 0.8 in insertion option not available with liquid junction options D & E.
- 5.0 in insertion option not available with liquid junction options 1, 3, A, B.
- Manufactured as 1.5 in. depth, includes cable strain relief.
- There are two options to connect to a transmitter using terminal blocks:
  - Option 1 – use BNC / TC to PIN adapter with conduit fitting or BNC / TC to PIN adapter. In either case temperature compensator code must be 2 or 4.
  - Option 2 – select T in integral cable code, not designed for use with extension cables or junction box.
- For direct connection to type TB82, APA592, TB84, 4630 / 35 and AX46 transmitters, or other supplier devices, using terminal blocks.
- TB556: junction box or submersible (immersion) connector mounted on sensor. Cable length approximately 102 mm (4 in.). Requires extension cable for temperature compensator code must be 0, 2 or 4.
- TB(X)556: junction box mounted on sensor. Cable length approximately 102 mm (4 in.). Requires extension cable for connection to transmitter. If junction box is ordered separately and longer cable lengths are required, enter cable length in code for integral cable.

## TB557 and TBX557 hot-tap retractable sensors

TB(X)557 sensors are hot-tap, ball valve insertion sensors. They enable sensor maintenance or replacement without interrupting the process.

An integral safety anti-blowout lip is incorporated into the sensor design, preventing accidental sensor removal. Unlike chain restraints, this safety-by-design is an integral part of the sensors' construction.

The sensor is inserted through a standard 1½ in. or 1¼ in. full port ball valve which is sold separately. Connection to a ball valve is by compression fitting available in either hand-tight with 1¼ in. NPT threads or wrench-tight with 1 in. NPT threads.

Additional fittings enable the assembly to be flushed and drained in situ and use a 1½ in. NPT thread for connection to the ball valve.



TB557 and TBX557 sensors

## Specification

### Applications

Insertion, hot-tap

### Maximum pressure / temperature

690 kPa (100 psi) at 80 °C (176 °F)

276 kPa (40 psi) at 140 °C (284 °F)

### Features

Insert / retract without disturbing process flow

Replaceable electrode

Anti-blowout lip

No internal high-impedance connection

### Material

Electrode Body	Kynar (PVDF) as standard
Sensor sheath variants	316 stainless steel Hastelloy or Titanium
External O-rings	Viton
Junction	Wood or PTFE
Junction types	Flush (flat only) Notched
Lengths	Standard 406 mm (16 in.) Maximum 1524 mm (60 in.)

## Overall dimensions

Dimensions in mm (in.)

### Ball valve

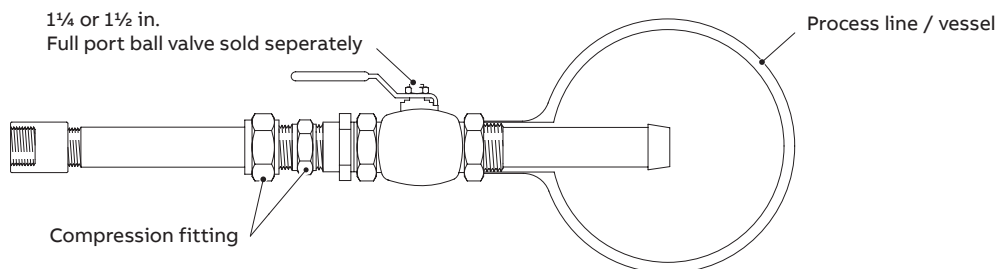

### Compression fittings

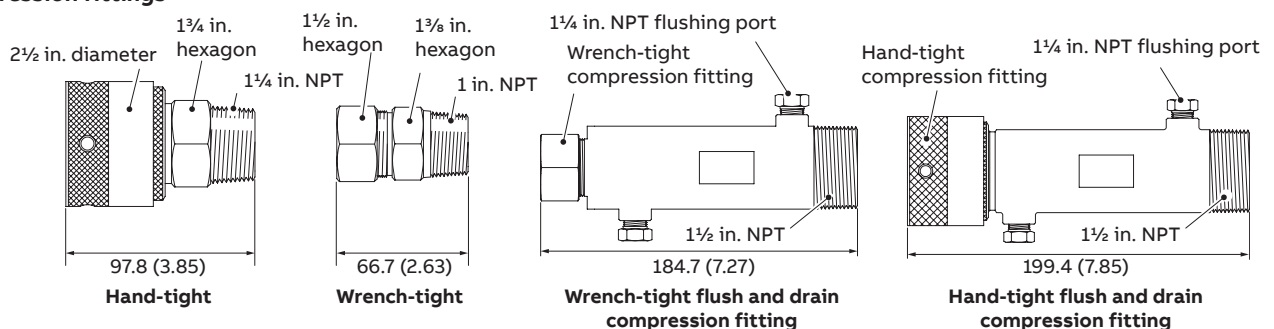

## ...Overall dimensions

Dimensions in mm (in.)

### TB(X)557

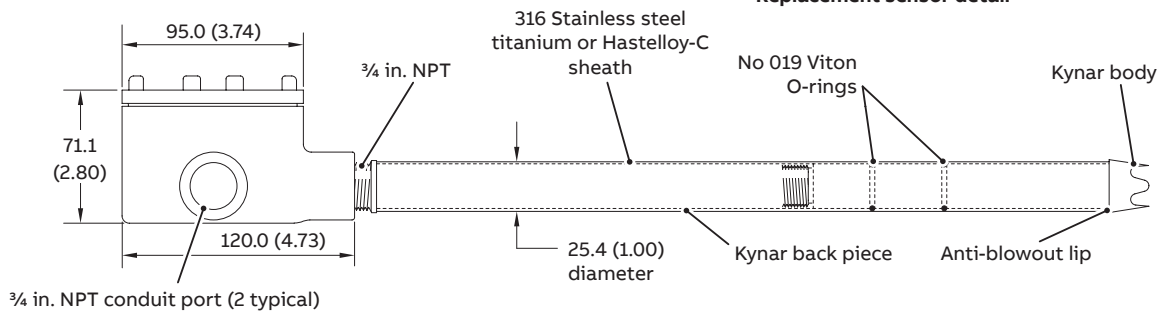
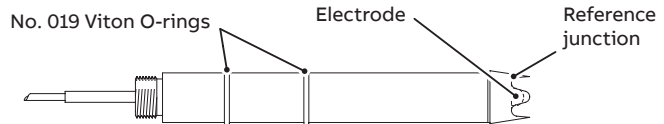
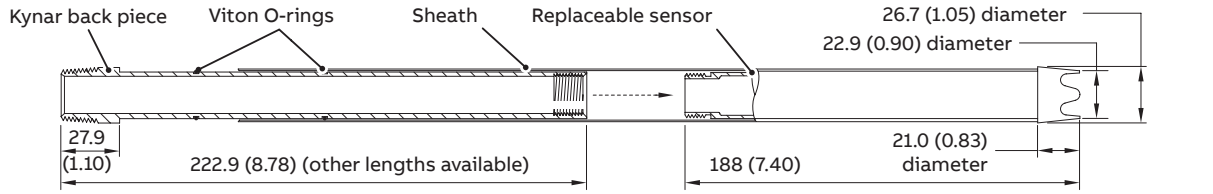

3/4 in. NPT conduit port (2 typical)

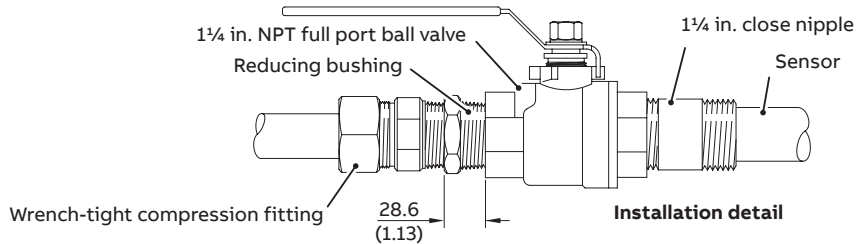
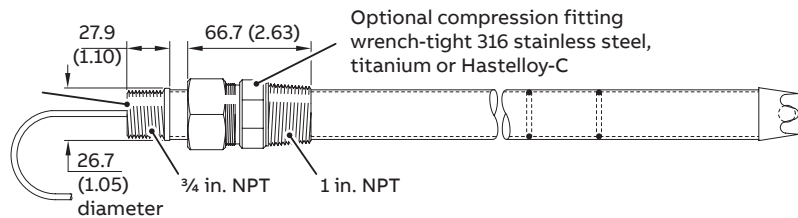
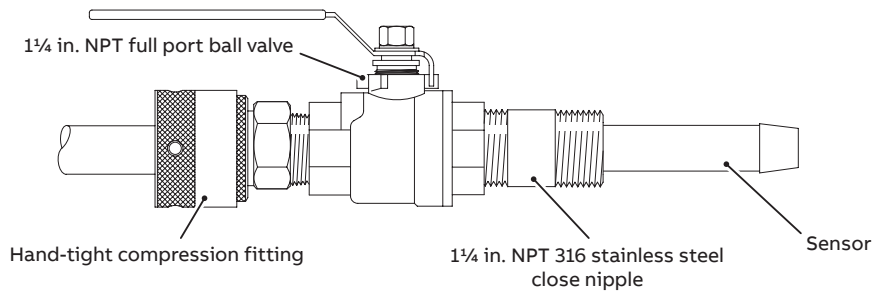
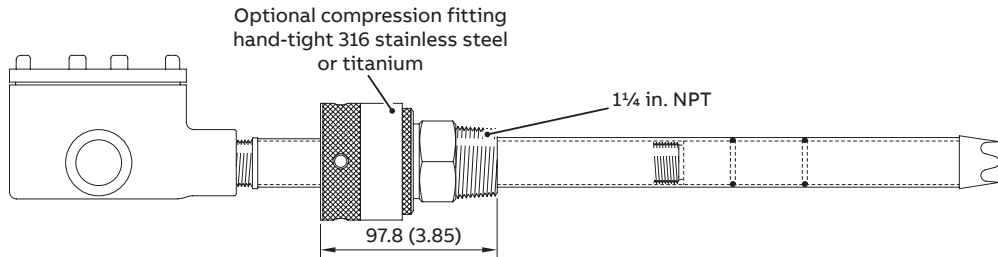







**Notes.**

- 1 Not available for Redox (ORP) electrodes (codes 5 & A).
- 2 Not available for fluoride-resistant electrodes (code F). Compatible with APA592, TB82, TB84, 4630 / 35 and AX46 instruments.
- 3 Flush junctions for flat electrodes only (code 6).
- 4 Unless noted, standard hardware kits have Viton O-rings. Ball valve and process coupling sold separately.
- 5 Applicable for all body styles. Mandatory for replacement sensors (code 0 in Body Style section).
- 6 There are two options to connect to a transmitter using terminal blocks:
  - Option 1 – use BNC / TC to PIN adapter with conduit fitting or BNC / TC to PIN adaptor. In either case temperature compensator code must be 2 or 4.
  - Option 2 – select T in integral sensor code, not designed for use with extension cables or junction box.
- 7 For direct connection to type APA592, TB82, TB84, 4630 / 35 and AX46 transmitters, or other supplier devices, using terminal blocks.
- 8 TB557: junction box mounted on sensor. Cable length varies to match body length style. Order code for body style and accessory hardware anything except zero. Requires extension cable. Order code for temperature compensator must be 0, 2 or 4.
- 9 TB(X)557: junction box mounted on sensor. Cable length approximately 102 mm (4 in.). Order code for body style and accessory hardware anything except zero. Code – ##### 0, J, B. Requires extension cable. If junction box is ordered separately and longer cable lengths are desired, enter cable length in integral sensor code.
- 10 Standard cable length of 4 ft. (1.2 m) as measured from rear of sensor assembly with 16 in. sheath only. Maximum 29 ft. (8.8 m) cable only available with 16 in. sheath. Longer sheaths decrease length accordingly.
- 11 Applicable to sensors with junction boxes only.
- 12 Supplied with Integral sensor cable option 0 and Integral temperature compensator options 2 and 4 only.
- 13 Sheath lengths are approximately: 15.850 in (16 in), 19.850 in (20 in), 23.820 in (24 in), 29.769 in (30 in), and 59.638 in (60 in).

## TB561 and TBX561 Sterilizable sensors

TB(X)561 sensors are designed for sterilizable or in-line applications and for measurements in process vessels or lines requiring periodic sterilization or cleaning. They are also used in the TB18 Safe-T-Clean valve and 4TB9515-0190 stainless steel flow cell.

The sensors are designed for use with a bushing and union nut but can also be retro-fitted into standard DN25 bushings with 0.983 in. to 0.995 in. internal diameters. All hardware required for use with the TB18 Safe-T-Clean or 4TB9515-0190 flowcell is included with valve or flowcell when purchased.

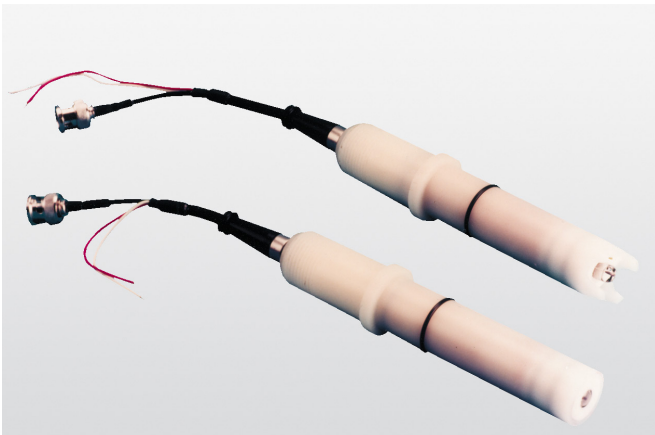

TB561 and TBX561 sensors

## Specification

### Applications

Batch processing with steam or chemical sterilization, fermenters, glass-lined reactors, pharmaceuticals, food and beverage

### Maximum pressure / temperature

- 690 kPa (100 psi) at 90°C (176 °F)
- 448 kPa (65 psi) at 121 °C (250 °F)
- 276 kPa (40 psi) at 140 °C (284 °F)

### Material

Electrode body	Kynar (PVDF) as standard
Junction	Wood or PTFE
Junction types	Flush Notched

### Insertion depth

- 100 mm
- (100 mm required for TB18 Safe-T-Clean valve and flowcell)

## Overall dimensions – TB(X)561

Dimensions in mm (in.)

### Notes.

1. Dashed lines represent dimensions of flow cell kit with Swagelock fittings.
2. Flow cell kit without Swagelock fittings 4tb9515-0223  
flow cell kit with Swagelock fittings 4tb9515-0190

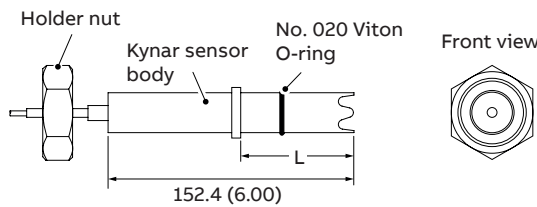

Order code 100:L = 100.0 (3.94)

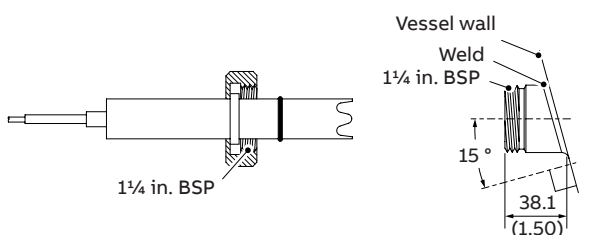
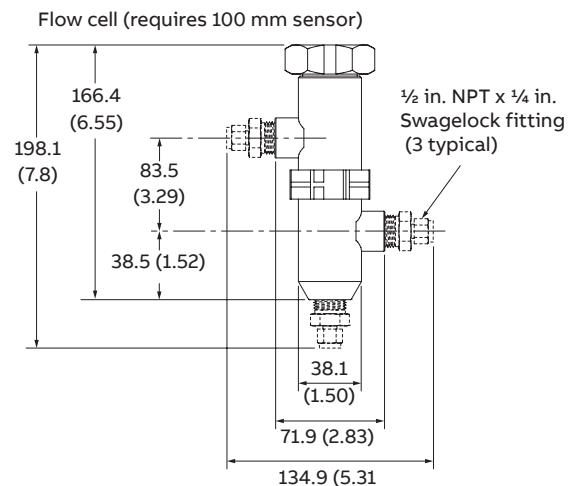

**Note.** Customer-supplied holder nut slides over sensor and threads onto tank bushing

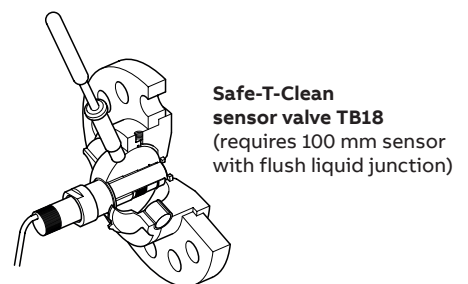

**Safe-T-Clean sensor valve TB18**  
(requires 100 mm sensor with flush liquid junction)

## Ordering information – TB561

<b>Standard solid-state sensors – no solution ground rod</b>	<b>TB561</b>	<b>X</b>	<b>X</b>	<b>X</b>	<b>X X X</b>	<b>X</b>	<b>X X</b>
<b>Next Step sterilizable Kynar body pH / ORP sensor assembly (448 kPa [65 psi] at 121 °C [250°F])</b>							
<b>Measuring electrode</b>							
Flat glass (10 to 100 °C, 0 to 14 pH) for high particulates with flow at 90 ° 8		1					
Glass, pH (0 to 100 °C, 0 to 12 pH)		2					
High temperature glass (5 to 140 °C, 0 to 14 pH)		3					
Platinum, Redox (ORP)		5					
Gold, Redox (ORP)		A					
Glass, pH, fluoride-resistant (10 to 80 °C, 0 to 12 pH)		F					
Coat-resistant glass / high temperature (5 to 140 °C, 0 to 14 pH)		J					
<b>Integral temperature compensator</b>							
None		0					
3 kΩ Tinned leads 2		1					
3 kΩ Extension cable connector 2		2					
Pt100 Tinned leads 2,3		3					
Pt100 Extension cable connector 2,3		4					
<b>Reference junction</b>							
Wood, flush				1			
PTFE, flush				3			
Wood, notched 7				5			
PTFE, notched 7				6			
Wood, flush, Next Step reference				A			
PTFE, flush, Next Step reference				B			
Wood, notched, Next Step reference 7				D			
PTFE, notched, Next Step reference 7				E			
<b>Solution ground rod material</b>				N/A			
<b>O-ring material</b>				N/A			
<b>Insertion depth</b>							
100 mm 9					1 0 0		
<b>Units of measure, integral sensor cable 5</b>							
BNC connector, feet							F
Tinned / Pin leads, feet 1							T
Use when JB / JS (below) are selected 6,7							O
<b>Integral sensor cable</b>							
1 ft. (0.3 m) to (30 ft) 8.8 m enter length (in 5 ft. increments)							--
With junction box 6,7							J B
Less junction box / submersible coupler 6,7							J S

**Notes.**

- 1 For direct connection to type TB82, APA592, TB84, 4630 / 35 and AX46 transmitters or other supplier devices, using terminal blocks.
- 2 Not available for Redox (ORP) electrodes (codes 5 & A).
- 3 Not available for fluoride resistant electrodes (code F). Compatible with TB82, TB84, APA592, 4630 / 35 and AX46 instruments.
- 4 Insertion depth measured from wetted face of sensor flange to tip of guard.
- 5 There are two options to connect to a transmitter using terminal blocks:
  - Option 1 – use BNC / TC to PIN adapter with conduit fitting or BNC / TC to PIN adapter. In either case temperature compensator code must be 2 or 4.
  - Option 2 – select T in integral cable code, not designed for use with extension cables or junction box .
- 6 TB561: junction box mounted on sensor. Cable length approximately 102 mm (4 in.). Requires extension cable. If junction box is ordered separately and longer cable lengths are required enter length under code position for integral cable.
- 7 Not compatible with all TB18 Safe-T-Clean valve styles.
- 8 Required for use in most TB18 Safe-T-Clean valves.
- 9 Required for use with TB18 Safe-T-Clean valves and 4TB9515-0190 flowcell. Consult TB18 product specification sheet for comprehensive measuring electrode selection.

## Ordering information – TBX561

<b>Sensors for self-checking – with solution ground rod</b>	<b>TBX561</b>	<b>X</b>	<b>X</b>	<b>X</b>	<b>X</b>	<b>X</b>	<b>X X X</b>	<b>X</b>	<b>X X</b>
<b>Next Step Advantage, sterilizable <sup>1</sup> Kynar body pH / ORP sensor assembly (448 kPa [65 psi] at 121 °C [250°F])</b>									
<b>Measuring electrode</b>									
Flat glass (10 to 100 °C, 0 to 14 pH) for high particulates with flow at 90 ° <sup>8</sup>	1								
Glass, pH (0 to 100 °C, 0 to 12 pH)	2								
High temperature glass (5 to 140 °C, 0 to 14 pH)	3								
Platinum, Redox (ORP)	5								
Gold, Redox (ORP)	A								
Glass, pH, fluoride-resistant (10 to 80 °C, 0 to 12 pH)	F								
Coat-resistant glass / high temperature (5 to 140 °C, 0 to 14 pH)	J								
<b>Integral temperature compensator</b>									
None	0								
3kΩ Tinned leads <sup>2</sup>	1								
Pt100 Tinned leads <sup>2,3</sup>	3								
<b>Reference junction</b>									
Wood, flush				1					
PTFE, flush				3					
Wood, notched <sup>7</sup>				5					
PTFE, notched <sup>7</sup>				6					
Wood, flush, Next Step reference				A					
PTFE, flush, Next Step reference				B					
Wood, notched, Next Step reference <sup>7</sup>				D					
PTFE, notched, Next Step reference <sup>7</sup>				E					
<b>Solution ground rod material</b>									
316 stainless steel					1				
Titanium					2				
Hastelloy B2					3				
<b>O-ring material</b>									
Viton						1			
EPDM						2			
Silicone						3			
Kalrez						4			
<b>Insertion depth <sup>4</sup></b>									
100 mm <sup>9</sup>							1 0 0		
<b>Units of measure, integral sensor cable <sup>5</sup></b>									
Tinned / Pin leads, feet <sup>1</sup>									T
Use when JB / JS (below) are selected <sup>6,7</sup>									0
<b>Length, integral sensor cable</b>									
1 ft. (0.3 m) 30 ft. (8.8 m) enter length (in 5 ft. increments)									--
With junction box <sup>6,7</sup>									JB
Less junction box <sup>6,7</sup>									JS

**Notes.**

- For direct connection to type TB82, APA592, TB84, 4630 / 35 and AX46 transmitters or other supplier devices, using terminal blocks.
- Not available for Redox (ORP) electrodes (codes 5 & A).
- Not available for fluoride resistant electrodes (code F). Compatible with TB82, TB84, APA592, 4630 / 35 and AX46 instruments.
- Insertion depth measured from wetted face of sensor flange to tip of guard.
- There are two options to connect to a transmitter using terminal blocks:
  - Option 1 – use BNC / TC to PIN adapter with conduit fitting or BNC / TC to PIN adapter. In either case temperature compensator code must be 2 or 4.
  - Option 2 – select T in integral cable code, not designed for use with extension cables or junction box .
- TBX561: junction box mounted on sensor. Cable length approximately 102mm (4 in.). Requires extension cable. If junction box is ordered separately and longer cable lengths are required enter length under code position for integral cable.
- Not compatible with all TB18 Safe-T-Clean valve styles.
- Required for use in most TB18 Safe-T-Clean valves.
- Required for use with TB18 Safe-T-Clean valves and 4TB9515-0190 flowcell. Consult TB18 Product Specification sheet for comprehensive measuring electrode selection.

## TB564 and TBX564 high pressure hot-tap retractable sensors

TB(X)564 are high pressure, hot-tap, ball valve, insertion sensors. They permit sensor maintenance or replacement without interrupting the process.

For safety reasons, it is recommended that the operating pressure be reduced below 690 kPa (100 psi) during insertion and retraction of the sensor assembly.

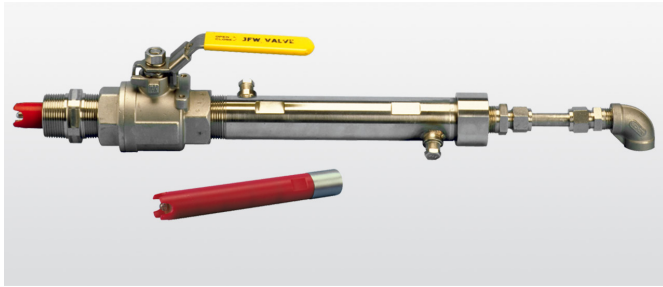

TB564 and TBX564 sensors

## Specification

### Applications

High pressure, hazardous materials

### Maximum pressure / temperature

2065 kPa (300 psi) at 140 °C (284 °F)

### Features

- Insert / retract without complete process shutdown\*
- Retraction housing for safety
- Taps for flushing or pressurizing

### Material

Electrode body	Kynar (PVDF)
Ball-valve / hardware	316 stainless steel
External O-rings	Viton
Junction	Wood or PTFE
Junction types	Flush Notched

\* Safe operating pressure limits are recommended during retraction / insertion; maximum 690 kPa (100 psi).

## Overall dimensions – TB(X)564

Dimensions in mm (in.)

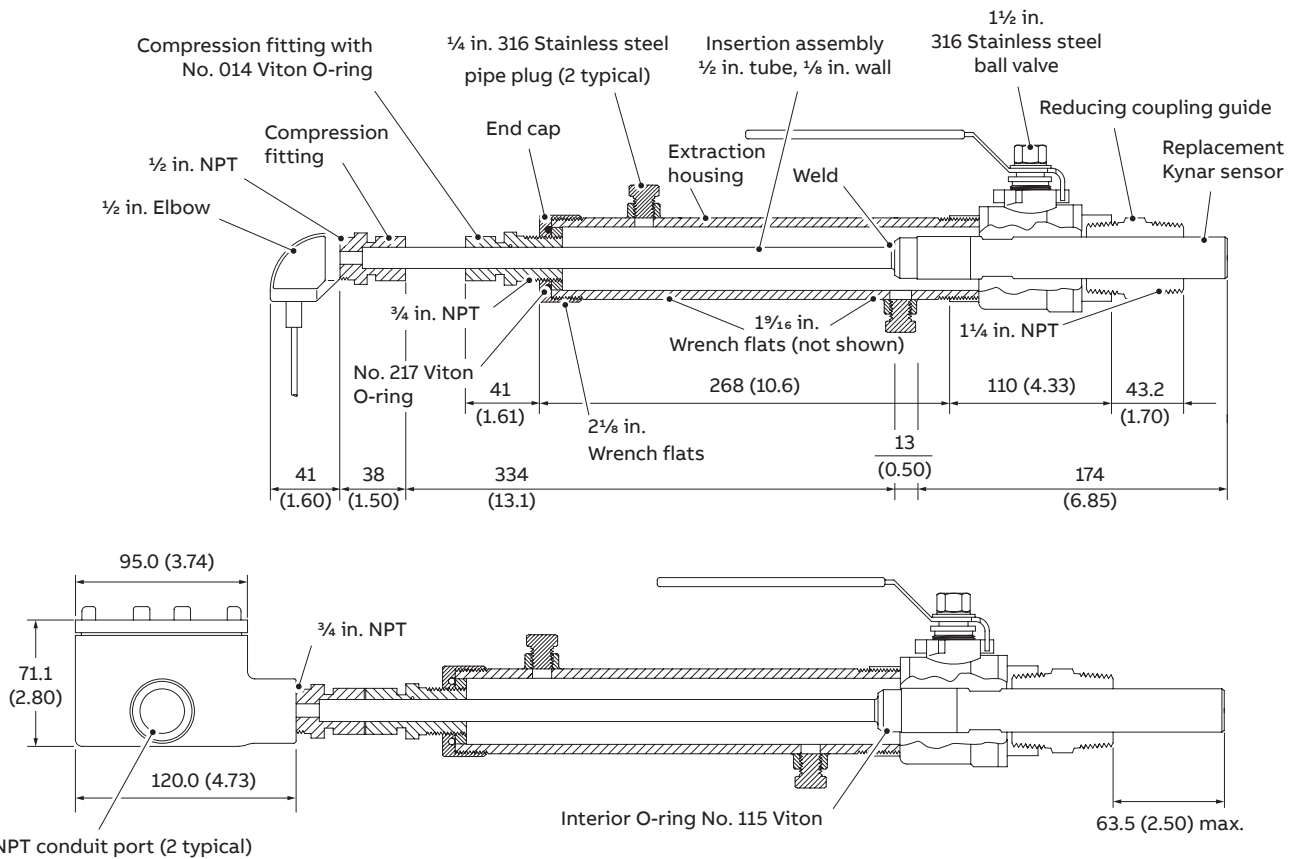

**Note.**  
All pipe threads have Loctite® PST sealant applied at the factory.

## Ordering information – TB564

Standard solid-state sensors – no solution ground rod	TB564	X	X	X	X	X	X	X	X
<b>Next Step high pressure hot-tap pH / Redox (ORP) <sup>1</sup> sensor assembly (2065 kPa [300psi] at 140 °C [284°F])</b>									
<b>Measuring electrode</b>									
Flat glass (10 to 100 °C, 0 to 14 pH) for high particulates with flow at 90 °°	1								
Glass, pH (0 to 100 °C, 0 to 12 pH)	2								
High temperature glass (5 to 140 °C, 0 to 14 pH)	3								
Platinum, Redox (ORP)	5								
Gold, Redox (ORP)	A								
Glass, pH, fluoride-resistant (10 to 80 °C, 0 to 12 pH)	F								
Coat-resistant glass / high temperature (5 to 140 °C, 0 to 14 pH)	J								
<b>Integral temperature compensator</b>									
None	0								
3 kΩ Tinned leads <sup>2</sup>	1								
3 kΩ Extension cable connector <sup>2</sup>	2								
Pt100 Tinned leads <sup>2,3</sup>	3								
Pt100 Extension cable connector <sup>2,3</sup>	4								
<b>Reference junction</b>									
Wood, flush						1			
PTFE, flush						3			
Wood, notched						5			
PTFE, notched						6			
Wood, flush, Next Step reference						A			
PTFE, flush, Next Step reference						B			
Wood, Notched, Next Step reference						D			
PTFE, Notched, Next Step reference						E			
<b>Solution ground rod material</b>							N/A		
<b>O-ring material</b>							N/A		
<b>Body style</b>									
Standard, Kynar sensor body								0	
<b>Accessory hardware</b>									
Replacement sensor only <sup>4</sup>								0	
Model TB(X)564 sensor assembly, <b>with</b> ball valve and coupling								9	
Model TB(X)564 sensor assembly, <b>without</b> ball valve and coupling								A	
<b>Units of measure, integral sensor cable <sup>5</sup></b>									
BNC connector, feet <sup>7</sup>									F
Tinned / Pin leads, feet (recommended) <sup>1</sup>									T
Use when JB / JS (below) are selected <sup>6</sup>									0
<b>Integral sensor cable</b>									
1 ft. (0.3 m) to 29 ft. (8.8 m) enter length (in 5 ft. increments)									--
With junction box <sup>6</sup>									J B
Less junction box <sup>6</sup>									J S

**Notes.**

- 1** For direct connection to type TB82, APA592, TB84, 4630 / 35 and AX46 transmitters or other supplier devices using terminal blocks.
- 2** Not available for Redox (ORP) electrodes (codes 5 & A).
- 3** Not available for fluoride-resistant electrodes (code F). Compatible with TB82, APA592, TB84, 4630 / 35 and AX46 instruments.
- 4** Integral cable type T recommended, otherwise installation of BNC connector kit is required.
- 5** There are two options to connect to a transmitter using terminal blocks:
  - Option 1 – use BNC / TC to PIN adapter with conduit fitting or BNC / TC to PIN adapter. In either case temperature compensator code must be 2 or 4.
  - Option 2 – select T in sensor cable code, not designed for use with extension cables or junction box.
- 6** Junction box mounted on insertion rod. Cable length approximately 254 mm (10 in.). Requires extension cable to connect to transmitter. Order code for temperature compensator must be 0, 2 or 4. If sensor is ordered without accessory hardware a junction box must be ordered separately.
- 7** Requires BNC field mount for replacement sensors.
- 8** Maximum pressure: 690 kPa (100 psi).

## Ordering information – TBX564

<b>Sensors for self-checking – with solution ground rod</b>	<b>TBX564</b>	<b>X</b>	<b>X</b>	<b>X</b>	<b>X</b>	<b>X</b>	<b>X</b>	<b>X</b>	<b>X</b>	<b>X</b>	<b>X</b>
<b>Next Step Advantage, high pressure, hot-tap, pH / ORP sensor assembly (2065 kPa [300psi] at 140 °C [284°F])</b>											
<b>Measuring electrode</b>											
Flat glass (10 to 100 °C, 0 to 14 pH) for high particulates with flow at 90 ° <sup>8</sup>		1									
Glass, pH (0 to 100 °C, 0 to 12 pH)		2									
High temperature glass (5 to 140 °C, 0 to 14 pH)		3									
Platinum, Redox (ORP)		5									
Gold, Redox (ORP)		A									
Glass, pH, fluoride-resistant (10 to 80 °C, 0 to 12 pH)		F									
Coat-resistant glass / high temperature (5 to 140 °C, 0 to 14 pH)		J									
<b>Integral temperature compensator</b>											
None		0									
3kΩ Tinned leads <sup>2</sup>		1									
Pt100 Tinned leads <sup>2,3</sup>		3									
<b>Reference junction</b>											
Wood, flush				1							
PTFE, flush				3							
Wood, notched				5							
PTFE, notched				6							
Wood, flush, Next Step reference				A							
PTFE, flush, Next Step reference				B							
Wood, Notched, Next Step reference				D							
PTFE, Notched, Next Step reference				E							
<b>Solution ground rod material</b>											
316 stainless steel						1					
Titanium						2					
Hastelloy B2						3					
<b>O-ring material</b>											
Viton								1			
EPDM								2			
Silicone								3			
Kalrez								4			
<b>Body style</b>											
Standard, Kynar sensor body									0		
<b>Accessory hardware</b>											
Replacement sensor only <sup>4</sup>										0	
Model TB(X)564 sensor assembly, <b>with</b> ball valve and coupling										9	
Model TB(X)564 sensor assembly, <b>without</b> ball valve and coupling										A	
<b>Units of measure, integral sensor cable<sup>6</sup></b>											
Tinned / Pin leads, feet (recommended) <sup>1</sup>											T
Use when JB / JS (below) are selected <sup>6</sup>											0
<b>Integral sensor cable</b>											
1 ft. (0.3 m) to 29 ft. (8.8 m) enter length (in 5 ft. increments)											--
With junction box <sup>6</sup>											JB
Less junction box <sup>6</sup>											JS

### Notes.

- For direct connection to type TB82, APA592, TB84, 4630 / 35 and AX46 transmitters or other supplier devices using terminal blocks.
- Not available for Redox (ORP) electrodes (codes 5 & A).
- Not available for fluoride-resistant electrodes (code F). Compatible with TB82, APA592, TB84, 4630 / 35 and AX46 instruments.
- Integral cable type T recommended, otherwise installation of BNC connector kit is required.
- There are two options to connect to a transmitter using terminal blocks:
  - Option 1 – use BNC / TC to PIN adapter with conduit fitting or BNC / TC to PIN adapter. In either case temperature compensator code must be 2 or 4.
  - Option 2 – select T in sensor cable code, not designed for use with extension cables or junction box.
- Junction box mounted on insertion rod. Cable length approximately 254 mm (10 in.). Requires extension cable to connect to transmitter. Order code for temperature compensator must be 0, 2 or 4. If sensor is ordered without accessory hardware a junction box must be ordered separately.
- Requires BNC field mount for replacement sensors.
- Maximum pressure: 690 kPa (100 psi).

## TB567 and TBX567 high pressure in-line sensors

TB(X)567 sensors are high pressure, in-line sensors. Their permissible pressure and temperature ratings are unique in the industry.

The assembly comprises two parts: a 316 stainless steel housing and a molded Ryton sensor body.

For applications above 1725 kPa (250 psi), please consult ABB.



TB567 and TBX567 sensors

## Specification

### Applications

High pressure insertion

### Maximum pressure / temperature

1380 kPa (200 psi) at 140 °C (284 °F)

1725 kPa (250 psi) at 100 °C (212 °F)

### Features

2-piece sensor, double O-ring

Sealed body with stainless steel sleeve

### Material

Electrode body	Ryton (Polyphenylene sulphide)
Outer sleeve	316 stainless steel
External O-rings	Viton
Junction	Wood or PTFE
Junction types	Flush

## Overall dimensions – TB(X)567

Dimensions in mm (in.)

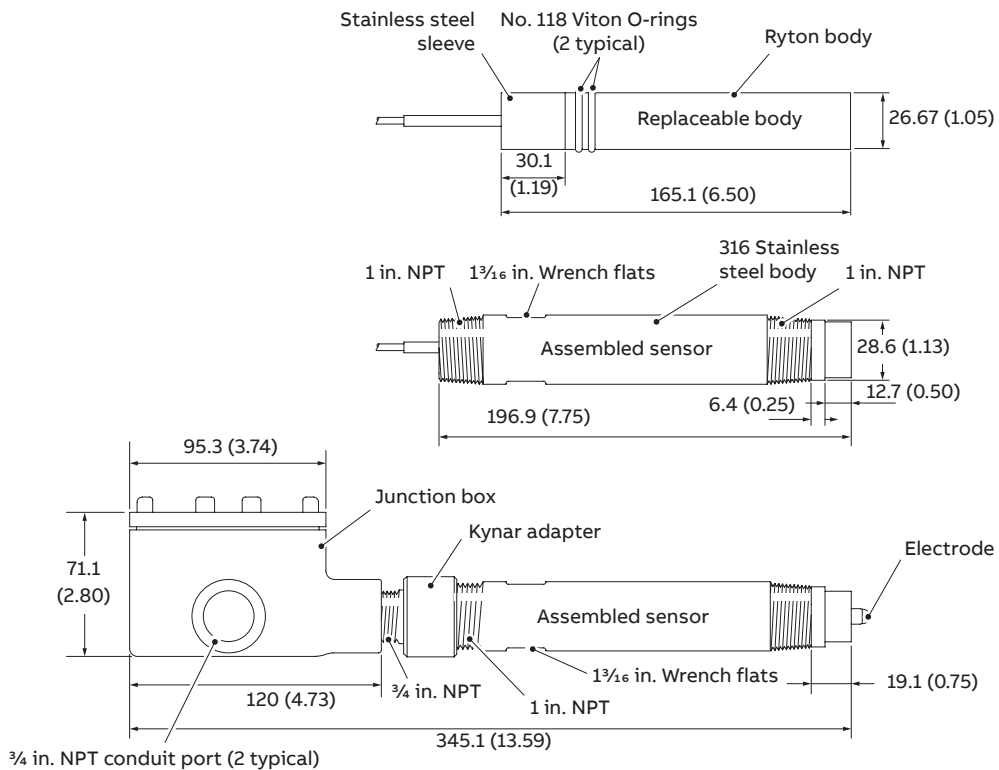



## Ordering information – TB567

Standard solid-state sensors – no solution ground rod	TB567	X	X	X	X	X	X	X	X
Next Step in-line high-pressure pH / Redox (ORP) sensor assembly (1380 kPa [200 psi] at 140°C [284°F])									
<b>Measuring electrode</b>									
Glass, pH (0 to 100 °C, 0 to 12 pH)		2							
High temperature glass (5 to 140 °C, 0 to 14 pH)		3							
Platinum, Redox (ORP)		5							
Gold, Redox (ORP)		A							
Glass, pH, fluoride-resistant (10 to 80 °C, 0 to 12 pH)		F							
Coat-resistant glass / high temperature (5 to 140 °C, 0 to 14 pH)		J							
<b>Integral temperature compensator</b>									
None			0						
3 kΩ Tinned leads <sup>2</sup>			1						
3 kΩ Extension cable connector <sup>2</sup>			2						
Pt100 Tinned leads <sup>2,3</sup>			3						
Pt100 Extension cable connector <sup>2,3</sup>			4						
<b>Reference junction</b>									
Wood, flush				1					
PTFE, flush				3					
Wood, flush, Next Step reference				A					
PTFE, flush, Next Step reference				B					
<b>Solution ground rod material</b>									
					N/A				
<b>O-ring material</b>									
					N/A				
<b>Body style</b>									
Model TB(X)567 sensor body							0		
<b>Accessory hardware</b>									
None								0	
Model TB(X)567 316 stainless steel sensor housing								8	
<b>Units of measure, integral sensor cable <sup>4</sup></b>									
BNC connector, feet									F
Tinned / Pin leads, feet <sup>1</sup>									T
Use when JB / JS (below) are selected <sup>5</sup>									0
<b>Integral sensor cable</b>									
1 ft. (0.3 m) to 29 ft. (8.8 m) enter length (in 5 ft. increments)									--
With junction box <sup>5</sup>									J B
Less junction box <sup>5</sup>									J S

**Notes.**

- For direct connection to type TB82, APA592, TB84, 4630 / 35 and AX46 transmitters or other supplier devices using terminal blocks.
- Not available for Redox (ORP) electrodes (codes 5 & A).
- Not available for fluoride-resistant electrodes (code F). Compatible with TB82, TB84, 4630 / 35 and AX46 instruments.
- There are two options to connect to a transmitter using terminal blocks:
  - Option 1– use BNC / TC to PIN adapter with conduit fitting or BNC / TC to PIN adapter. In either case temperature compensator code must be 2 or 4.
  - Option 2 – select T in sensor cable code, not designed for use with extension cables or junction box.
- Junction box mounted on sensor. Cable length approximately 254 mm (10 in.). Requires extension cable to connect to transmitter. Order code for temperature compensator must be 0, 2 or 4. If sensor is ordered without accessory hardware a junction box must be ordered separately.

## Ordering information – TBX567

Sensors for self-checking – with solution ground rod Next Step Advantage, in-line, high pressure, pH / ORP <sup>1</sup> sensor assembly (1380 kPa [200 psi] at 140°C [284°F])	TBX567	X	X	X	X	X	X	X	X	X	X
<b>Measuring electrode</b>											
Glass, pH (0 to 100 °C, 0 to 12 pH)		2									
High temperature glass (5 to 140 °C, 0 to 14 pH)		3									
Platinum, Redox (ORP)		5									
Gold, Redox (ORP)		A									
Glass, pH, fluoride-resistant (10 to 80 °C, 0 to 12 pH)		F									
Coat-resistant glass / high temperature (5 to 140 °C, 0 to 14 pH)		J									
<b>Integral temperature compensator</b>											
None		0									
3kΩ Tinned leads <sup>2</sup>		1									
Pt100 Tinned leads <sup>2,3</sup>		3									
<b>Reference junction</b>											
Wood, flush				1							
PTFE, flush				3							
Wood, flush, Next Step reference				A							
PTFE, flush, Next Step reference				B							
<b>Solution ground rod material</b>											
316 stainless steel					1						
Titanium					2						
Hastelloy B2					3						
<b>O-ring material</b>											
Viton						1					
EPDM						2					
Silicone						3					
Kalrez						4					
<b>Body style</b>											
Standard, Kynar sensor body								0			
<b>Accessory hardware</b>											
None									0		
Model TB(X)567 316 stainless steel sensor housing									8		
<b>Units of measure, integral sensor cable <sup>4</sup></b>											
Tinned / Pin leads, feet <sup>1</sup>										T	
Use when JB / JS (below) are selected <sup>5</sup>										0	
<b>Integral sensor cable</b>											
1 ft. (0.3 m) to 29 ft. (8.8 m) enter length (in 5 ft. increments)											--
With junction box <sup>5</sup>											JB
Less junction box <sup>5</sup>											JS

### Notes.

- For direct connection to type TB82, APA592, TB84, 4630 / 35 and AX46 transmitters or other supplier devices using terminal blocks.
- Not available for Redox (ORP) electrodes (codes 5 & A).
- Not available for fluoride-resistant electrodes (code F). Compatible with TB82, TB84, 4630 / 35 and AX46 instruments.
- There are two options to connect to a transmitter using terminal blocks:
  - Option 1– use BNC / TC to PIN adapter with conduit fitting or BNC / TC to PIN adapter. In either case temperature compensator code must be 2 or 4.
  - Option 2 – select T in sensor cable code, not designed for use with extension cables or junction box.
- Junction box mounted on sensor. Cable length approximately 254 mm (10 in.). Requires extension cable to connect to transmitter. Order code for temperature compensator must be 0, 2 or 4. If sensor is ordered without accessory hardware a junction box must be ordered separately.

## Accessories

### Automatic cleaners

ABB sensors are designed to resist fouling and plugging especially when placed in sufficient velocity.

Sometimes a lack of velocity or the precipitative properties of the liquid require the use of an automatic cleaner.

ABB supplies jet-wash type cleaning facilities for submersion (immersion) TB556 sensors with 1½ in. insertion depth.

When coupled to a customer-supplied solenoid valve delivering wash fluid, effective cleaning can be initiated by ABB pH instrumentation such as the TB84PH or AX46 series.

For example, the TB84PH can be configured:

- wash cycle time      0 to 99.99 hours
- wash on time         0 to 999 seconds
- wash recovery time   0 to 999 seconds
- hold function         ON or OFF



Hydraulic cleaner with TB(X)556 sensor

### Hydraulic cleaner application example

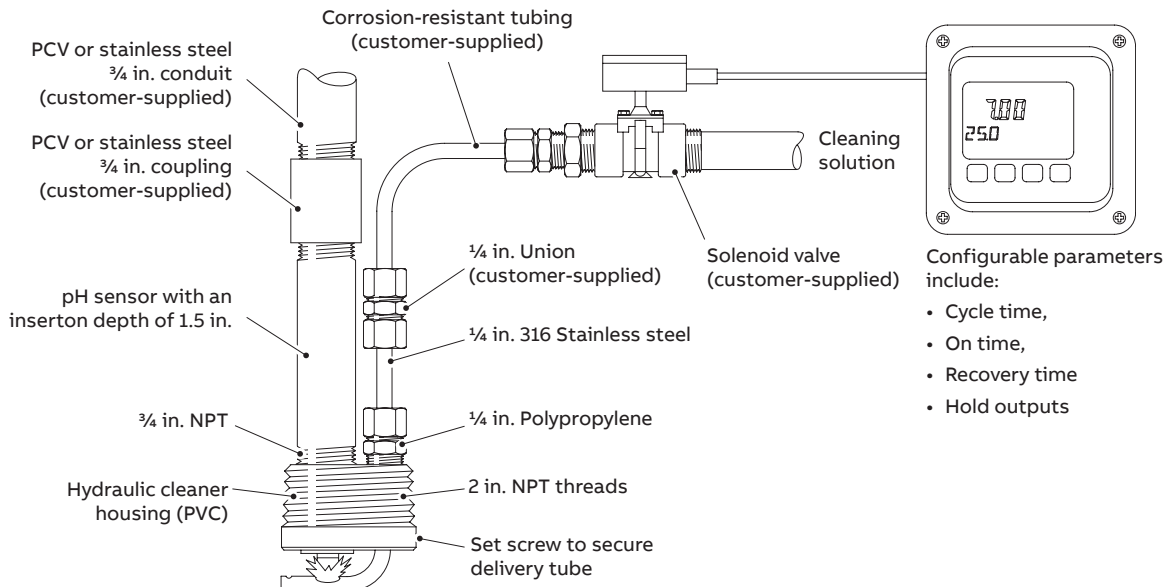

## Specification

### Model

4TB5205-0232

### Materials

PVC, Polypropylene  
316 stainless steel

### Maximum pressure / temperature

690 kPa (100 psi) at 40 °C (104 °F)  
276 kPa (40 psi) at 60 °C (140 °F)

## ...Accessories

### Ball valve kits for TB(X)557 sensors

For use with compression fittings without flush and drain assemblies:

Model	Description
4TB5205-0174	1¼ in. 316 stainless steel ball valve kit for use with 1 in. wrench-tight compression fitting*
4TB5205-0255	1½ in. 316 stainless steel ball valve kit for use with 1 in. wrench-tight compression fitting*
4TB5205-0217	1¼ in. 316 stainless steel ball valve kit for use with 1¼ in. hand-tight compression fitting*
4TB5205-0254	1½ in. 316 stainless steel ball valve kit for use with 1¼ in. hand-tight compression fitting*
4TB5205-0175	1½ in. Kynar (PVDF) ball valve kit for use with 1 in. wrench-tight compression fitting*
4TB5205-0218	1½ in. Kynar (PVDF) ball valve kit for use with 1¼ in. hand-tight compression fitting*

\*Kits include ball valve and appropriately sized process connector and reducing bushing.

For use with compression fittings with flush and drain assemblies:

Model	Description
4TB5205-0285	1½ in. 316 stainless steel ball valve with 1½ in. process connector

### Miscellaneous

Model	Description
4TB9515-0164	Female BNC to pin leads adaptor
4TB9515-0244	Cable grip with reducer (1½ in. to 1 in) for use with junction box
4TB9515-0277	Temperature compensator extension cable connector to pin leads adaptor

---

## Acknowledgements

- Hastelloy® is a registered trademark of Haynes International Inc.
- Kalrez® and Viton are registered trademarks of DuPont
- Dow Elastomers L.L.C. Kynar® is a registered trademark of Elf Atochem North America Inc.
- LOCTITE® is a registered trademark of Loctite Corporation
- Ryton® is a registered trademark Chevron Phillips Chemical Company
- Swagelok is a copyright of Swagelok Company. All rights reserved.
- Next Step™ and Next Step Advantage™ are trademarks of ABB Automation Inc.

---

## Notes

Sales



Service





---

**ABB Limited**  
**Measurement & Analytics**

Oldends Lane  
Stonehouse  
Gloucestershire GL10 3TA  
UK  
Tel: +44 (0)1453 826 661  
Fax: +44 (0)1453 829 671  
Email: [instrumentation@gb.abb.com](mailto:instrumentation@gb.abb.com)

**ABB Inc.**  
**Measurement & Analytics**

125 E. County Line Road  
Warminster PA 18974  
USA  
Tel: +1 215 674 6000  
Fax: +1 215 674 7183

**[abb.com/measurement](http://abb.com/measurement)**

---

We reserve the right to make technical changes or modify the contents of this document without prior notice. With regard to purchase orders, the agreed particulars shall prevail. ABB does not accept any responsibility whatsoever for potential errors or possible lack of information in this document.

We reserve all rights in this document and in the subject matter and illustrations contained therein. Any reproduction, disclosure to third parties or utilization of its contents – in whole or in parts – is forbidden without prior written consent of ABB.  
© ABB, 2020