



HY13-1525-M1/US

TGK Motor Service Procedure

Effective: April 2015



Low Speed High Torque Hydraulic Motors



WARNING

FAILURE OR IMPROPER SELECTION OR IMPROPER USE OF THE PRODUCTS AND/OR SYSTEMS DESCRIBED HEREIN OR RELATED ITEMS CAN CAUSE DEATH, PERSONAL INJURY AND PROPERTY DAMAGE.

This document and other information from Parker Hannifin Corporation, its subsidiaries and authorized distributors provide product and/or system options for further investigation by users having technical expertise. It is important that you analyze all aspects of your application and review the information concerning the product or system in the current product catalog. Due to the variety of operating conditions and applications for these products or systems, the user, through its own analysis and testing, is solely responsible for making the final selection of the products and systems and assuring that all performance, safety and warning requirements of the application are met.



The products described herein, including without limitation, product features, specifications, designs, availability and pricing, are subject to change by Parker Hannifin Corporation and its subsidiaries at any time without notice.

© Copyright 2015, Parker Hannifin Corporation, All Rights Reserved

Contents

Definitions3
 Design Features4
 Introduction5
 Troubleshooting Guide6
 Troubleshooting Checklist.....7
 Tools & Materials Required for Servicing8
 Bolt Torque9
 Exploded Assembly View.....10
 TGK Service Parts List Chart 11-12
 Disassembly & Inspection..... 13-20
 Torqmotor Assembly 21-28
 Final Checks.....29
 Hydraulic Fluid29
 Filtration29
 Oil Temperature.....29
 Tips for Maintaining the System30

Definitions

 <p>WARNING</p>	<p>A warning describes hazards or unsafe practices which could result in severe personal injury or death.</p>
 <p>CAUTION</p>	<p>A caution describes hazards or unsafe practices which could result in personal injury or product or property damage.</p>
<p>NOTE</p>	<p>A note gives key information to make following a procedure easier or quicker.</p>

Disclaimer

This Service Manual has been prepared by Parker Hannifin Corporation for reference and use by mechanics who have been trained to repair and service hydraulic motors on commercial and non-commercial equipment applications. Parker Hannifin Corporation has exercised reasonable care and diligence to present accurate, clear and complete information and instructions regarding the techniques and tools required for maintaining, repairing and servicing the Parker TGK LSHT Motors. Since this is a general Service Manual, the photographs and illustrations may not look exactly like the motor being serviced. The procedures, therefore, must be carefully read and understood before servicing.

If inspection or testing reveals evidence of abnormal wear or damage to the TGK motor or if you encounter circumstances not covered in the Manual, STOP - CONSULT THE EQUIPMENT MANUFACTURER'S SERVICE MANUAL AND WARRANTY. DO NOT TRY TO REPAIR OR SERVICE A TGK MOTOR WHICH HAS BEEN DAMAGED OR INCLUDES ANY PART THAT SHOWS EXCESSIVE WEAR UNLESS THE DAMAGED AND WORN PARTS ARE REPLACED WITH ORIGINAL PARKER REPLACEMENT AND SERVICE PARTS AND THE UNIT IS RESTORED TO PARKER SPECIFICATIONS FOR THE TGK MOTOR.

It is the responsibility of the mechanic performing the maintenance, repairs or service on a particular motor to (a) inspect the unit for abnormal wear and damage, (b) choose a repair procedure which will not endanger his/her safety, the safety of others, the equipment or the safe operation of the motor, and (c) fully inspect and test the motor and the hydraulic system to ensure that the repair or service of the motor has been properly performed and that the motor and hydraulic system will function properly.

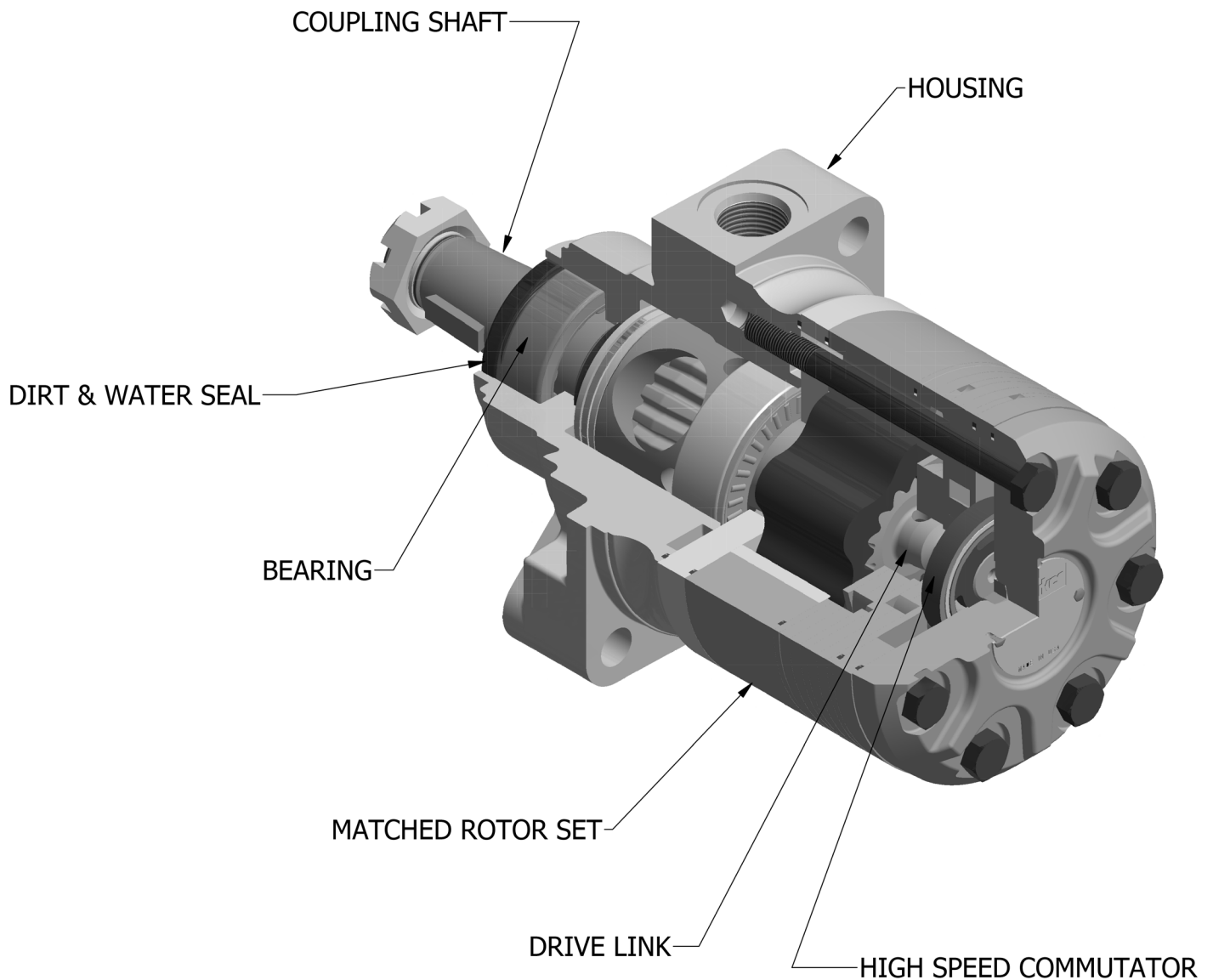
**TGK Series features include:**

- The roller vane rotor set design offers low-friction and wear compensation which maximizes the useful performance life of the motor.
- Zero leak commutation valve provides greater, more consistent volumetric efficiency.
- Heavy duty spline geometry.
- Flow thru lubrication provides cooling extending motor life.
- Full interchangeability with other motors which are designed according to industry standards.
- Compatible with most hydraulic systems with regard to pressure, torque and speed.
- A unique high-pressure shaft seal that eliminates the need for case drains.
- Up to 45 horsepower output.
- Heavy duty roller bearings for high side loads.

Introduction

This service manual has one purpose: to guide you in maintaining, troubleshooting and servicing the TGK Torqmotor (low speed, high torque hydraulic motor).

Material in this manual is organized so you can work on the Torqmotor and get results without wasting time or being confused. To get these results, you should read this entire manual prior to beginning work on the Torqmotor.

This manual also contains troubleshooting information and checklist. If you must service the Torqmotor, the checklist will help you to determine where the problem may be.

The three-column format of the Disassembly and Inspection, and Assembly sections will make it easier for you to conduct major work on the Torqmotor. Column 1 gives a brief key for each procedure. Column 2 explains in detail the procedure you should follow. Column 3 illustrates this procedure with photographs. Read all information carefully and pay special attention to the notes, cautions and warnings.

A page the with exploded assembly view is provided several places in this manual. The component part names and item numbers assigned on this exploded assembly view correspond with names and item numbers (in parentheses) used in the disassembly and assembly procedures set forth in this manual.

Service part list charts are also provided in this manual with the part names and exploded view item numbers cross referenced to Parker service part numbers. Service parts are available through the Original Equipment Manufacturer or Parker approved TGK Distributors.

As you gain experience in servicing the Torqmotor, you may find that some information in this manual could be clearer or more complete. If so, let us know about it. Do not try to second guess the manual. If you are stuck, contact us. Servicing the Torqmotor should be a safe and productive procedure, in order for the unit to deliver the reliable, long-life operation engineered into it.

Troubleshooting Guide

NOTE	Before troubleshooting any system problem, check service literature published by the equipment and/or component manufacturers. Follow their instructions, if given, for checking any component other than the Torqmotor unit.
-------------	---

Preparation

Make your troubleshooting easier by preparing as follows:

- work in a clean, well-lighted place
- have proper tools and materials nearby
- have an adequate supply of clean, petroleum-based solvent

! WARNING	Since solvents are flammable, be extremely careful when using any solvent. Even a small explosion could cause injury or death.
------------------	--

! WARNING	Wear eye protection and be sure to comply with OSHA and other maximum air pressure requirements.
------------------	--

Preliminary Checks

Hydraulic systems are often trouble-free. Hence, the problem an operator complains of could be caused by something other than the hydraulic components.

Thus, once you have determined that a problem exists, start with the easy-to-check items, such as:

- Parts damaged from impact that were not properly repaired, or that should have been replaced
- Improper replacement parts used in previous servicing
- Mechanical linkage problems such as binding, broken or loose parts, or slipping belts

Hydraulic Components

If you think the problem is caused by a hydraulic component, start by checking the easy-to-reach items.

Check all hoses and lines for cracks, hardening or other signs of wear. Reroute any usable hoses that are kinked, severely bent, or that rest against hot parts. Look for leaks, especially at couplings and fittings. Replace any hoses or lines that don't meet system flow and pressure ratings.

Next, go to the reservoir and filters. Check fluid level and look for air bubbles. Check the filter(s). A filter with a maximum of 20 micron filtration is recommended for the Torqmotor system.

Visually check other components to see if they are loosely mounted, show signs of leaks, or other damage or wear.

Excessive heat in a hydraulic system can create problems that can easily be overlooked. Every system has its limitation for the maximum amount of temperature. After the temperature is attained and passed, the following can occur:

- oil seal leaks
- loss of efficiency such as speed and torque
- pump loss of efficiency
- pump failure
- hoses become hard and brittle
- hose failure

A normal temperature range means an efficient hydraulic system. Consult the manuals published by equipment and/or component manufacturers for maximum allowable temperatures and hydraulic tests that may be necessary to run on the performance of the hydraulic components. The Torqmotor is not recommended for hydraulic systems with maximum temperatures above 200° F (93.3° C).

Trouble	Cause	Remedy
Oil Leakage	1. Hose fittings loose, worn or damaged.	Check & replace damaged fittings or "O" Rings. Torque to manufacturers specifications.
	2. Oil seal rings (5) deteriorated by excess heat.	Replace oil seal rings by disassembling Torqmotor unit.
	3. Special bolt (1) loose or its sealing area deteriorated by corrosion.	(a) Loosen then tighten single bolt to torque specification. (b) Replace bolt.
	4. Internal shaft seal (18) worn or damaged.	Replace seal. Disassembly of Torqmotor unit necessary.
	5. Worn coupling shaft (14) and internal seal (18).	Replace coupling shaft and seal by disassembling Torqmotor unit.
Significant loss of speed under load	1. Lack of sufficient oil supply	(a) Check for faulty relief valve and adjust or replace as required. (b) Check for and repair worn pump. (c) Check for and use correct oil for temperature of operation.
	2. High internal motor leakage	Replace worn rotor set by disassembling Torqmotor unit.
	3. Severely worn or damaged internal splines.	Replace rotor set, drive link and coupling shaft by disassembling Torqmotor unit.
	4. Excessive heat.	Locate excessive heat source (usually a restriction) in the system and correct the condition.
Low mechanical efficiency or undue high pressure required to operate Torqmotor unit	1. Line blockage	Locate blockage source and repair or replace.
	2. Internal interference	Disassemble Torqmotor unit, identify and remedy cause and repair, replacing parts as necessary.
	3. Lack of pumping pressure	Check for and repair worn pump.
	4. Excessive binding or loading in system external to Torqmotor unit.	Locate source and eliminate cause.

CAUTION: If the hydraulic system fluid becomes overheated [in excess of 200°F (93.3°C)], seals in the system can shrink, harden or crack, thus losing their sealing ability.

Tools and Materials Required for Servicing

- Clean, petroleum-based solvent
- Emery paper
- Vice with soft jaws
- Air-pressure source
- Arbor press
- Flat screwdriver
- Masking tape
- Breaker bar
- 1/4" torque wrench
- Sockets: 1/2 or 9/16 inch thin wall, 1 inch
- Allen wrenches: 3/16, 3/8 inch
- Adjustable crescent wrench or hose fitting wrenches
- SAE 10W40 SE or SF oil
- Special bearing mandrel for TGK Torqmotor (See Figure 1)
- Feeler gage .005 inch (.13 mm)
- |GK Torqmotor requires blind hole bearing puller for a 1.750 inch dia. (44.45 mm) and 2.750 inch dia. (69.85 mm)
- Clean corrosion resistant grease. Part #406018 is included in each seal kit. Recommended grease is Parker Specification #045236 or Mobil Mobilith SHC[®] 460.

**CAUTION**

Mixing greases that have different bases can be detrimental to bearing life.

CONVERSIONS

INCHES	mm	INCHES	mm
.020	.51	1.060	26.92
.021	.53	1.295	32.89
.029	.74	1.297	32.94
.030	.76	1.396	35.46
.111	2.81	1.398	35.51
.119	3.02	1.620	41.15
.152	3.86	1.622	41.20
.160	4.06	1.983	50.37
.296	7.52	1.985	50.42
.304	7.72	2.120	53.85
.460	11.68	2.122	53.90
.470	11.94	2.233	56.72
.500	12.70	2.235	56.77
.585	14.86	2.483	63.07
.595	15.11	2.485	63.12
.660	16.76	2.500	63.5
.675	17.15	2.88	73.2
1.058	26.87		

Torque Chart

Part Name	Item Number	Torque
bolt 3/8 24 UNF 2A	1	45-55 ft. lbs. (60-76 N m)
nut 1-1/4 18 UNEF 2B	29A or 29B	300-400 ft. lbs. (407-542 N m)

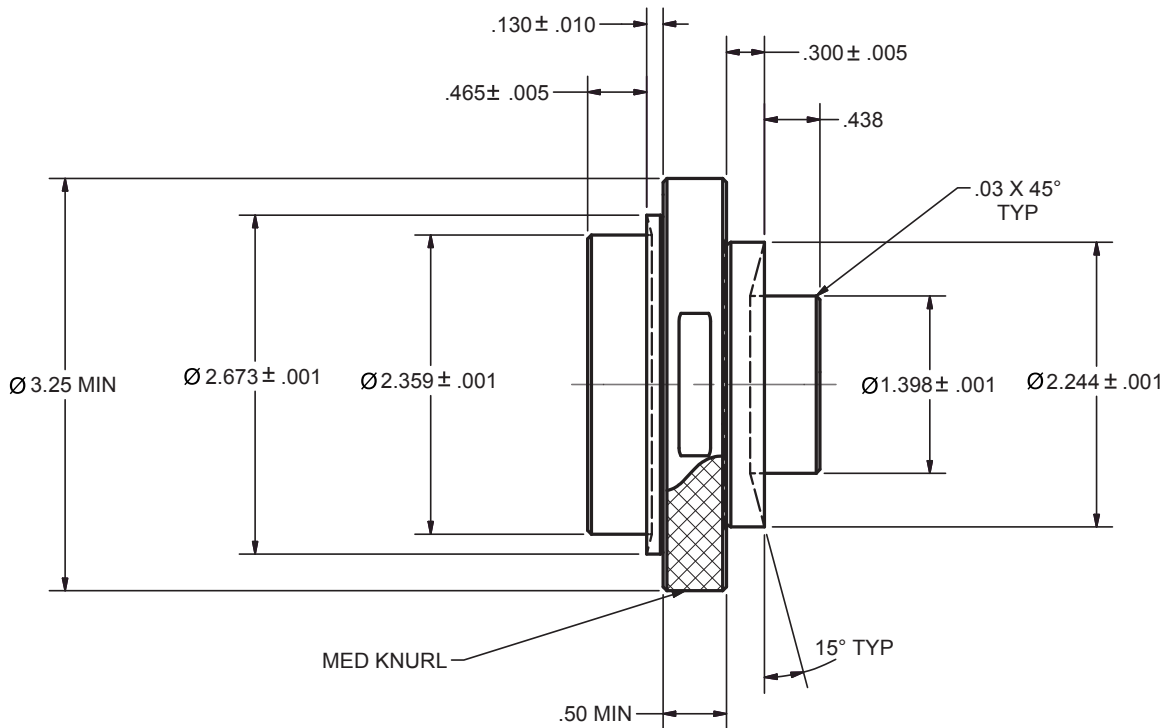

Typical Assembly

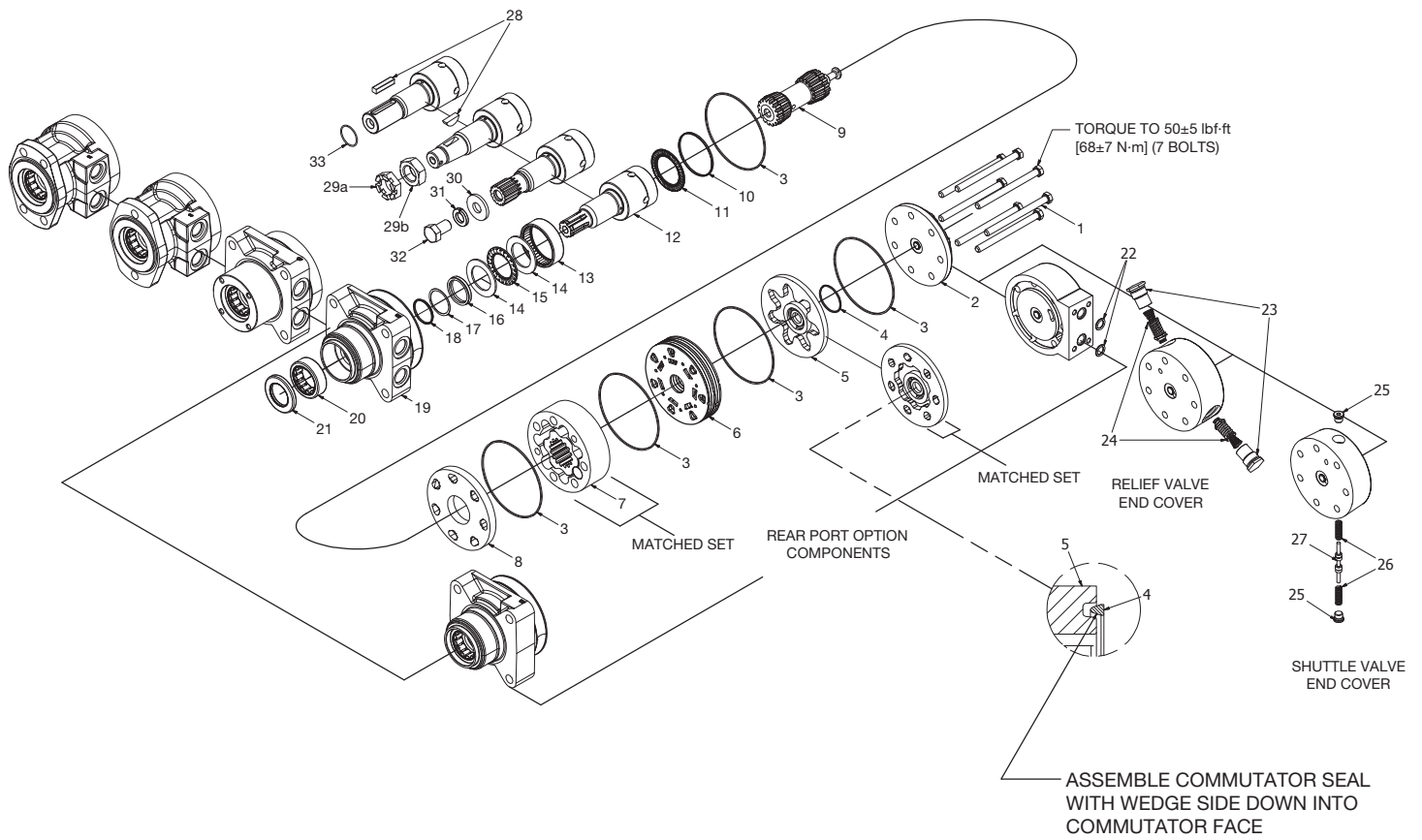

Item	Description
1	Special Bolt (7)
2	End Cover
3	Seal Ring (5)
4	Seal Ring - Commutator
5	Commutator Assembly (Matched Set)
6	Manifold
7	Rotor Set (Matched Set)
8	Wear Plate
9	Drive Link
10	Spacer
11	Thrust Bearing
12	Coupling Shaft
13	Radial Bearing
14	Thrust Washer (2)
15	Thrust Bearing
16	Shaft Seal
17	Back Up Washer
18	Back Up Ring
19	Housing
20	Radial Bearing
21	Dirt & Water Seal
22	O-Ring (2)
23	Plug (2)
24	Relief Valve (2)
25	Plug (2)
26	Spring (2)
27	Shuttle Valve
28	Key
29a	Castle Nut
29b	Patch Nut
30	Washer
31	Lock Washer
32	Bolt
33	Retaining Ring

Chart Use Example:

TGK0240US080AAAB Torqmotor includes part numbers listed to the right of TGK (SERIES), 0240 (DISP.), U (MOUNTING), S (PORTING), 08 (SHAFT), 0 (ROTATION), and AAAB (OPTION) shown in the left hand column of the chart.

Caution:

The charted component service information is for the Torqmotors listed only. Refer to the original equipment manufacturer of the equipment using the Torqmotor for assembly numbers not listed below.

SERIES

EXPLODED VIEW

ITEM#	5	6	8	10	11	13	14	15
DESCRIPTION	COMMUTATOR ASSEMBLY	MANIFOLD (SEE NOTE)	WEAR PLATE	THRUST BEARING RETAINING WASHER	THRUST BEARING	INNER BEARING	THRUST WASHER (2)	THRUST BEARING
TGK-Service Part#	TGK018000A1	TGK015000	477378	420109	070029	071035	400136 (2)	069017

EXPLODED VIEW

ITEM#	16	17	18	20	21
DESCRIPTION	SHAFT SEAL	BACKUP WASHER	BACKUP RING	OUTER BEARING	DIRT&WATER SEAL
TGK-Service Part#	032817	029118	028515	068027	478035

EXPLODED VIEW (Select Item # Bolt Per Option Group)

	1 OR	1A OR	1B OR	1C	THICKNESS OF ROTOR	7	7A	9	9
	STANDARD END COVER	SHUTTLE VALVE END COVER	REAR PORTED END COVER	RELIEF VALVE END COVER		ROTOR SET	FREE RUNNING ROTOR SET	DRIVE LINK	DRIVE LINK "L DIM"
DISPLACEMENT	BOLT # (BOLT LENGTH - 7 bolts required)								
(in3/rev)									
0110-6.7	021326 (3.750)	021018 (4.750)	021387 (5.000)	021387 (5.000)	.41835	TGK077003	TGK077004	TGK073000	4.413
0140-8.6	021271 (3.875)	021273 (4.875)	021379 (5.125)	021379 (5.125)	.53625	TGK097003	TGK097004	TGK093000	4.531
0170-10.3	021390 (4.000)	021413 (4.937)	021379 (5.125)	021379 (5.125)	.64215	TGK107003	TGK107004	TGK103000	4.637
0195-11.9	021376 (4.125)	021387 (5.000)	021291 (5.375)	021291 (5.375)	.74195	TGK127003	TGK127004	TGK123000	4.737
0240-14.5	021352 (4.250)	021379 (5.125)	021392 (5.500)	021392 (5.500)	.90405	TGK157003	TGK157004	TGK153000	4.899
0280-17.1	021272 (4.375)	021291 (5.375)	021412 (5.625)	021412 (5.625)	1.06615	TGK187003	TGK187004	TGK183000	5.061
0310-19.0	021476 (4.500)	021392 (5.500)	021385 (5.750)	021385 (5.750)	1.17835	TGK197003	TGK197004	TGK193000	5.173
0335-20.6	021340 (4.625)	021392 (5.500)	021378 (5.875)	021378 (5.875)	1.28435	TGK217003	TGK217004	TGK213000	5.279
0360-22.2	021018 (4.750)	021412 (5.625)	021366 (6.000)	021366 (6.000)	1.37185	TGK237003	TGK237004	TGK233000	5.367
0405-24.7	021413 (4.937)	021385 (5.750)	021415 (6.125)	021415 (6.125)	1.54005	TGK294003	TGK247004	TGK247003	5.534
0475-29.1	021379 (5.125)	021415 (6.125)	021394 (6.375)	021394 (6.375)	1.81425	TGK297003	TGK297004	TGK293000	5.809
0530-32.3	021291 (5.375)	021374 (6.250)	021393 (6.625)	021393 (6.625)	2.01375	TGK337003	TGK337004	TGK333000	6.009
0625-38.0	021385 (5.750)	021393 (6.625)	021329 (7.000)	021329 (7.000)	2.36915	TGK377003	TGK377004	TGK373000	6.364
0785-48.0	021394 (6.375)	021458 (7.312)	021477 (7.500)	021477 (7.500)	2.9926	TGK487003	N/A	TGK483000	6.988
0960-58.5	021329 (7.000)	##	021398 (8.125)	021398 (8.125)	3.6285	TGK587003	N/A	TGK583000	7.642

DISPLACEMENT GROUP

EXPLODED VIEW

ITEM#	2	19
DESCRIPTION	END COVER	SERVICE HOUSING HOUSING ASSEMBLY
AS - SAE "A" 2-Blot	TGK016000	Item 1 7/8-14 O-Ring TGK012010 TGK012010A1
LS - Wheel Mount w/ Brake Nose	TGK016000	Item 1 7/8-14 O-Ring TGK012003 TGK012003A1
HW - Wheel Mount (US) with Machined Pilot Nose	TGK016000	Item 1 G1/2 Milled TGK012006 TGK012006A1
MN - Standard SAE "A" 4-Bolt Flange	TGK016000	Item 1 Manifold W/M8 THD TGK012009 TGK012009A1
MS - Standard SAE "A" 4-Bolt Flange	TGK016000	Item 1 7/8-14 O-Ring TGK012011 TGK012011A1
MW - Standard SAE "A" 4-Bolt Flange	TGK016000	Item 1 G1/2 Milled TGK012004 TGK012004A1
RS - Wheel Mount Special Machine Nose	TGK016000	Item 1 7/8-14 O-Ring TGK012007 TGK012007A1
US - Wheel Mount	TGK016000	Item 1 7/8-14 O-Ring TGK012000 TGK012000A1

Front Porting
Mounting Code / Porting Code

EXPLODED VIEW

ITEM#	1, 1A, 1B, 1C
DESCRIPTION	END COVER BOLT PORTING SERVICE HOUSING HOUSING ASSEMBLY
EL - 6-Hole SAE "A" w/ Long Pilot	TGK016001 Item #1B Manifold M8 Threads TGK012002 TGK012002A1
UC - Wheel Mount	TGK016005 Item #1B 7/8-14 Rear Radial TGK012008 TGK012008A1

Rear Porting
Mounting Code / Porting Code

For reverse timed manifold, use TGK015001.



Service Parts List

SHAFT CODE	EXPLODED VIEW								
	ITEM#	12	28	29A	29B	30	31	32	33
	COUPLING DESCRIPTION	SHAFT	KEY	CASTLE NUT	PATCH NUT	WASHER	LOCK WASHER	BOLT	RETAINING RING
	01 - Long 6B Spline, Groove	TGK019004							
	05- 14 Tooth Spline (12/24 P), 5/8 Tap	TGK019008				028413	028413	021482	
	08- 1.25" Tapered, 1-20 Thread	TGK019002	038016*	025113	025126				
	19 - 1.38" Tapered, 1.125-18 Thread	TGK019007	038016*	025139	025138				
	44 - 14 Tooth Spline (12/24 P), Groove, 12mm Tap	TGK019009							
	45 - 1.25" Straight Key, Groove, 12mm Tap	TGK019003	039028 **						
	46 - 32mm Straight Key, 12mm Tap	TGK019005	039044 ***						401333

* 5/16 x 1
 ** .437 x .3115 sq
 *** 1.417 x .394 x .315 (10mm)

OPTION GROUP	EXPLODED VIEW				
	ITEM#	2	3	4	16
	DESCRIPTION	END COVER	SEAL RING (5)	COMMUTATOR SEAL	SHAFT SEAL
	AAAA-"Standard", Black Paint	TGK016000	032870	032435	032817
	AAAB-"Standard", No Paint	TGK016000	032870	032435	032817
	AAAC-"Standard", Double Paint	TGK016000	032870	032435	032817
	AAAF- Castle Nut, Black Paint	TGK016000	032870	032435	032817
	AAAG-Fluorocarbon (Section Seal Only), Black Paint	TGK016000	032869	032435	032818
	AAAH-Fluorocarbon (Section Seal Only), No Paint	TGK016000	032869	032435	032818
	AADD-Fluorocarbon (Section Seal Only), Castle Nut, No Paint	TGK016000	032869	032435	032818
	AAFW-Fluorocarbon (Section Seal Only), Black Paint	TGK016000	032869	032435	032818
	AAWT-Fluorocarbon (Section Seal Only), Castle Nut, Double Paint Black Paint	TGK016000	032869	032435	032818

OPTION GROUP	EXPLODED VIEW										
	ITEM#	1, 1A, 1B, 1C							23	24	24
		BOLT (7)	END COVER	SEAL RINGS (5)	COMMUTATOR SEAL	INNER SEAL	PLUG & O-RING ASSEMBLY	O-RING			
	AAAT-Bidirectional Shuttle Valve Endcover 11:00	Item #1A	TGK016002A1	032870	032435	032817	036297		401642	415563	
	AAAU-Bidirectional Shuttle Valve Endcover 11:00 & Castle Nut	Item #1A	TGK016002A1	032870	032435	032817	036297		401642	415563	
	BBBA-1000 PSI Cross Port Relief Endcover	Item#1C		032870	032435	032817	411063A1	032424	401701	410009-40	
	BBBG-1500 PSI Cross Port Relief Endcover	Item#1C	TGK016004A1	032870	032435	032817	411063A1	032424	401701	410009-07	
	BBBB-2000 PSI Cross Port Relief Endcover	Item#1C	TGK016004A3	032870	032435	032817	411063A1	032424	401701	410009-09	
	BBCG-2500 PSI Cross Port Relief Endcover	Item#1C		032870	032435	032817	411063A1	032424	401701	410009-11	
	BBBC-3000 PSI Cross Port Relief Endcover	Item#1C		032870	032435	032817	411063A1	032424	401701	410009-13	
	BBBD-4000 PSI Cross Port Relief Endcover	Item#1C		032870	032435	032817	411063A1	032424	401701	410009-16	
	BBGD-1750 PSI Cross Port Relief Endcover	Item #1C	TGK016004A2	032870	No Seal	032817	411063A1	032424	401701	410009-08	

Standard Buna seal kit SK000323 includes six #032870 seal rings, #032435 commutator seal, #032817 shaft seal, #028515 Back Up Ring, #029118 Back Up Washer, #478035 dirt & water seal, #406018 grease pack and bulletin #050099.

Fulorocarbon seal kit SK000324 includes six #032869 seal rings, #032435 commutator seal, #032818 shaft seal, #028515 Back Up Ring, #029118 Back Up Washer, #478035 dirt & water seal, #406018 grease pack and bulletin #050099.

Fulorocarbon & Hi-Temp Commutator seal kit SK000325 includes six #032869 seal rings, #032861 commutator seal, #032818 shaft seal, #028515 Back Up Ring, #029118 Back Up Washer, #478035 dirt & water seal, #406018 grease pack and bulletin #050099.

Hi-Temp Commutator seal kit SK000333 includes six #032870 seal rings, #032861 commutator seal, #032817 shaft seal, #028515 Back Up Ring, #029118 Back Up Washer, #478035 dirt & water seal, #406018 grease pack and bulletin #050099

TGK018001A1 commutator assembly is required if the designated option group is for rear porting.



Preparation Before Disassembly

- Before you disassemble the Torqmotor unit or any of its components read this entire manual. It provides important information on parts and procedures you will need to know to service the Torqmotor.
- Refer to “Tools and Materials Required for Services” section for tools and other items required to service the Torqmotor and have them available.
- Thoroughly clean off all outside dirt, especially from around fittings and hose connections, before disconnecting and removing the Torqmotor. Remove rust or corrosion from coupling shaft.
- Remove coupling shaft connections and hose fittings and immediately plug port holes and fluid lines.
- Remove the Torqmotor from system, drain it of fluid and take it to a clean work surface.
- Clean and dry the Torqmotor before you start to disassemble the unit.
- As you disassemble the Torqmotor clean all parts, except seals, in clean petroleum-based solvent, and blow them dry.

WARNING: petroleum-base solvents are flammable. Be extremely careful when using any solvent. Even a small explosion or fire could cause injury or death.

WARNING: WEAR EYE PROTECTION AND BE SURE TO COMPLY WITH OSHA OR OTHER MAXIMUM AIR PRESSURE REQUIREMENTS.

CAUTION: Never steam or high pressure wash hydraulic components. Do not force or abuse closely fitted parts.

- Keep parts separate to avoid nicks and burrs.
- Discard all seals and seal rings as they are removed from the Torqmotor. Replace all seals, seal rings and any damaged or worn parts with genuine Parker or OEM approved service parts.

CAUTION: Special lifting aids may be required to handle/service the TGK motor due to it's large size and weight. Take steps necessary to ensure that handling/service can be done safely.

Disassembly and Inspection

Place Torqmotor in a vise

1. Place the Torqmotor in a soft jawed vise or similar support, with coupling shaft (12) pointed down and the vise jaws clamping firmly on the sides of the housing (19) mounting flange. SEE FIGURE 1.

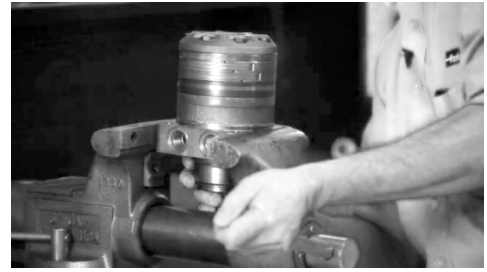

Figure 1

WARNING

WARNING IF THE TORQMOTOR IS NOT FIRMLY HELD IN THE VISE, IT COULD BE DISLODGED DURING THE SERVICE PROCEDURES, CAUSING INJURY.

Scribe alignment mark

2. Scribe an alignment mark down and across the Torqmotor components from end cover (2) to housing (19) to facilitate reassembly orientation where required. SEE FIGURE 2.

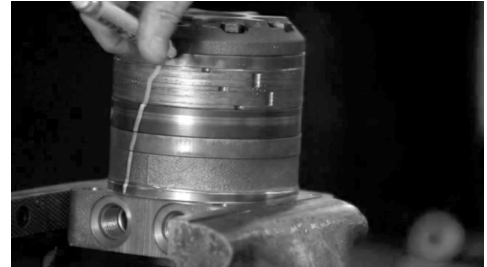

Figure 2

Remove special bolts & inspect bolts

3. Remove the seven special hex head bolts (1) using a 9/16 inch size socket. SEE FIGURE 3. Inspect bolts for damaged threads. Replace damaged bolts. SEE FIGURE 4.



Figure 3



Figure 4

Remove end cover

4. Remove end cover (2). SEE FIGURE 5.



Figure 5

Wash & inspect end cover

5. Thoroughly wash end cover (2) in proper solvent and blow dry. Be sure the end cover flow areas are free of contamination. Inspect end cover for cracks and the bolt head recesses for damage. Replace end cover as necessary. SEE FIGURE 6.

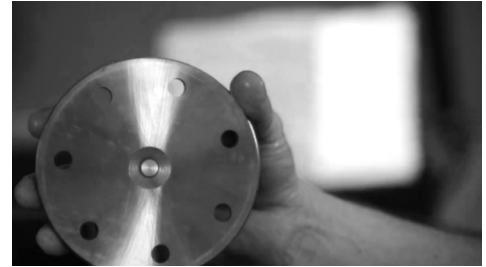

Figure 6

NOTE

A polished pattern (not scratches) on the cover from rotation of the commutator is normal. Discoloration would indicate excess fluid temperature, thermal shock, or excess speed and require system investigation for cause and close inspection of end cover, commutator, manifold, and rotor set.

Remove & inspect commutator

6. Remove commutator and seal ring (4) Remove seal ring from commutator, using an air hose to blow air into ring groove until seal ring is lifted out and discard seal ring. Inspect commutator for cracks or burrs, wear, scoring, spalling or brinelling. If any of these conditions exist, replace commutator. SEE FIGURES 7 and 8.



Figure 7



Figure 8

Disassembly and Inspection**Remove manifold**

7. Remove manifold (6) and inspect for cracks surface scoring, brinelling or spalling. Replace manifold if any of these conditions exist. SEE FIGURE 9. A polished pattern on the ground surface from commutator or rotor rotation is normal. Remove and discard the seal ring (3).



Figure 9

NOTE

The manifold is constructed of plates bonded together to form an integral component not subject to further disassembly for service.

Compare configuration of both sides of the manifold to ensure that same surface is reassembled against the rotor set.

Remove & inspect rotor set & wearplate

8. Remove rotor set (7) and wearplate (8), inspect together to retain the rotor set in its assembled form, maintaining the same rotor vane to stator contact surfaces. SEE FIGURE 10.



Figure 10

The drive link (9) may come away from the coupling shaft (12) with the rotor set, and wearplate. You may have to shift the rotor set on the wearplate to work the drive link out of the rotor and wearplate. Inspect the rotor set in its assembled form for nicks, scoring, or spalling on any surface and for broken or worn splines. If the rotor set component requires replacement, the complete rotor set must be replaced as it is a matched set. Inspect the wearplate for cracks, brinelling, or scoring. SEE FIGURE 11.

Discard seal rings (3) between the rotor set, and the wearplate.

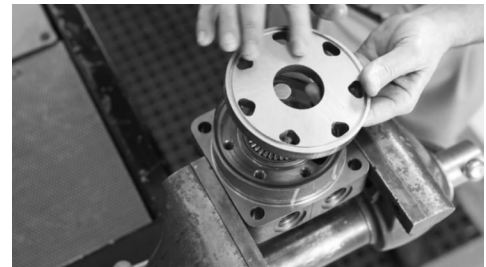

Figure 11

NOTE

The rotor set (7) components may become disassembled during service procedures. Marking the surface of the rotor and stator that is facing UP, with etching ink or grease pencil before removal from Torqmotor will ensure correct reassembly of rotor into stator and rotor set into Torqmotor. Marking all rotor components and mating spline components for exact repositioning at assembly will ensure maximum wear life and performance of rotor set and Torqmotor.

Disassembly and Inspection

NOTE Series TGK Torqmotor may have a rotor set with two stator halves with a seal ring (3) between them. Discard seal ring only if stator halves become disassembled during the service procedures.

NOTE A polished pattern on the wear plate from rotor rotation is normal.

Check rotor vane clearance

9. Place rotor set (7) and wear plate (8) on a flat surface and center rotor in stator such that two rotor lobes (180 degrees apart) and a roller vane centerline are on the same stator centerline. Check the rotor lobe to roller vane clearance with a feeler gage at this common centerline. If there is more than .005 inches (0.13 mm) of clearance, replace rotor set. SEE FIGURE 12.

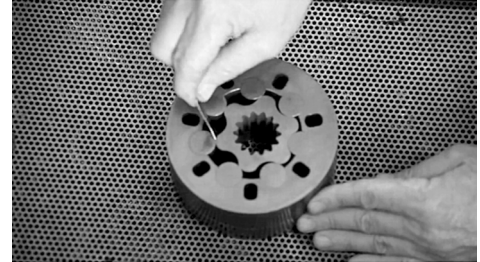

Figure 12

NOTE If rotor set (7) has two stator halves, check the rotor lobe to roller vane clearance at both ends of rotor.

Remove & inspect drive link

10. Remove drive link (9) from coupling shaft (12) if it was not removed with rotor set and wear plate. Inspect drive link for cracks and worn or damaged splines. No perceptible lash (play) should be noted between mating spline parts. SEE FIGURES 13 and 14.



Figure 13



Figure 14

Remove seal ring from housing

11. Remove and discard seal ring (3) from housing (19). SEE FIGURE 15.

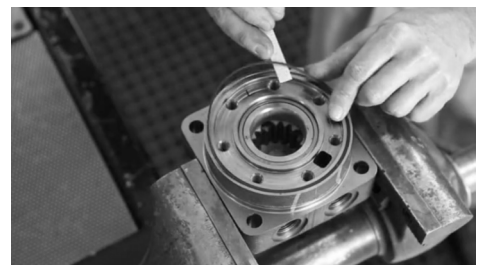

Figure 15

Disassembly and Inspection

Remove thrust bearing

12. Remove rear thrust bearing (11) and retaining bearing washer (10) from top of coupling shaft (12). Inspect for wear, brinelling, corrosion and a full complement of retained rollers. SEE FIGURE 16.

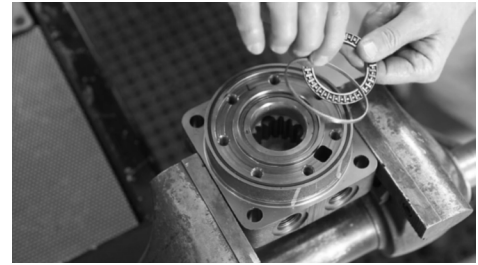

Figure 16

Check coupling shaft for rust or corrosion

12. Check exposed portion of coupling shaft (12) shaft for rust to be sure you have removed all signs of rust or corrosion which might prevent its withdrawal through the seal and bearing. Crocus cloth or fine emery paper may be used. Remove any key (28), nut (29A), washer, bolt, or lock washer still attached to the shaft. SEE FIGURE 17.

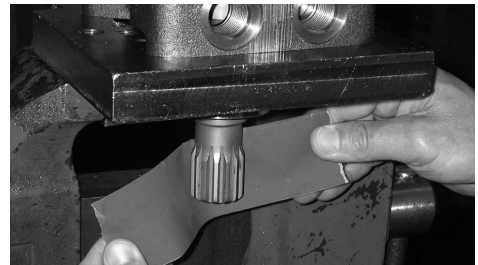

Figure 17

Remove & inspect coupling shaft

13. Remove coupling shaft (12), by pushing on the output end of shaft. SEE FIGURE 18. Inspect bearing and seal surfaces for spalling, nicks, grooves, severe wear or corrosion and discoloration. Inspect for damaged or worn internal and external splines or keyway. SEE FIGURE 19. Replace coupling shaft if any of these conditions exist.

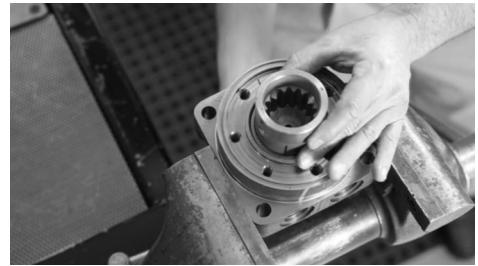

Figure 18

NOTE

Minor shaft wear in seal area is permissible. If wear exceeds .020 inches (0.51 mm) diametrically, replace coupling shaft.

NOTE

A slight "polish" is permissible in the shaft bearing areas. Anything more would require coupling shaft replacement.

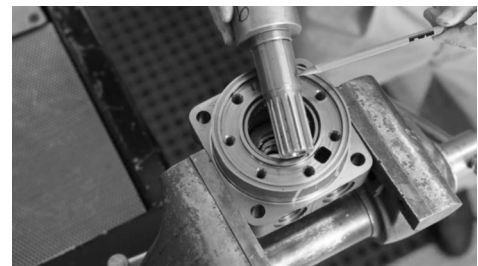

Figure 19

Disassembly and Inspection

Remove shaft seal, backup washer and backup ring

- 15. Remove shaft seal (16), backup washer (17), and backup ring (18) from TGK Series Torqmotor housing. Discard shaft seal and washers. SEE FIGURE 20.



Figure 20

Remove dirt & water seal

- 16. Remove housing (19) from vise, invert it and remove and discard dirt and water seal (21). A blind hole bearing or seal puller is required. SEE FIGURE 21

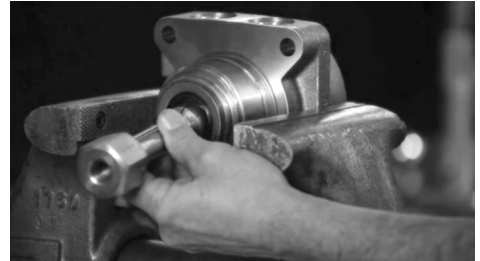

Figure 21

Inspect housing assembly

- 17. Inspect housing (19) assembly for cracks, the machined surfaces for nicks, burrs, brinelling or corrosion. Remove burrs that can be removed without changing dimensional characteristics. Inspect tapped holes for thread damage. SEE FIGURE 22. If the housing is defective in these areas, discard the housing assembly.

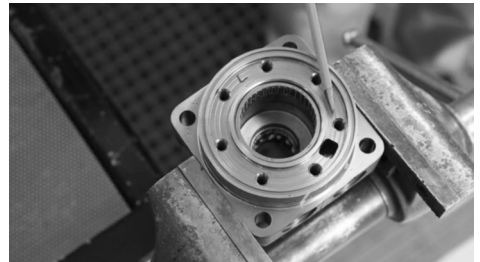

Figure 22

Disassembly and Inspection

Inspect housing bearings

18. If the housing (19) assembly has passed inspection to this point, inspect the housing bearings (20) and (13) and since they are captured in the housing cavity, the two thrust washers (14) and thrust bearing (15). The bearing rollers must be firmly retained in the bearing cages, but must rotate and orbit freely. All rollers and thrust washers must be free of brinelling and corrosion. SEE FIGURE 23.

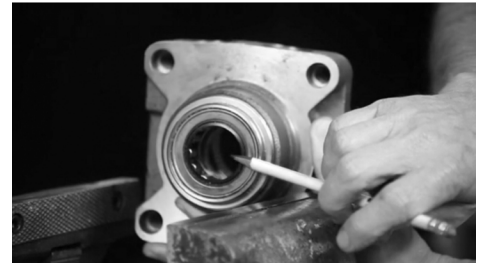

Figure 23

NOTE

The depth or location of bearing (13) in relation to the housing wear plate surface should be measured and noted before removing the bearings. This will facilitate the correct reassembly of new bearings.

Remove bearings

19. If the bearings must be replaced use a suitable size bearing puller to remove bearing (13) from housing (19) without damaging the housing. SEE FIGURE 24.



Figure 24

THE DISASSEMBLY OF TORQMOTOR IS NOW COMPLETE.

Torqmotor Assembly

- Replace all seals and seal rings with new ones each time you reassemble the Torqmotor unit. Lubricate seals and seal rings with clean recommended grease, Parker Gear grease specification #045236, E/M Lubricant #K-70M or Mobil Mobilith SHC® 460. A packet of grease (P/N 406018) is included in each seal kit.
- **NOTE: Complete seal kits are available. SEE FIGURE 25. The parts should be available through most OEM parts distributors or Parker approved Torqmotor distributors. (Contact your local dealer for availability).**
- **NOTE: Unless otherwise indicated, do not oil or grease parts before assembly.**
- Wash all parts in clean petroleum-based solvents before assembly. Blow them dry with compressed air. Remove any paint chips from mating surfaces of the end cover, commutator set, manifold rotor set, wear plate and housing and from port and sealing areas.

WARNING

SINCE THEY ARE FLAMMABLE, BE EXTREMELY CAREFUL WHEN USING ANY SOLVENT. EVEN A SMALL EXPLOSION OR FIRE COULD CAUSE INJURY OR DEATH.

WARNING

WEAR EYE PROTECTION AND BE SURE TO COMPLY WITH OSHA OR OTHER MAXIMUM AIR PRESSURE REQUIREMENTS.

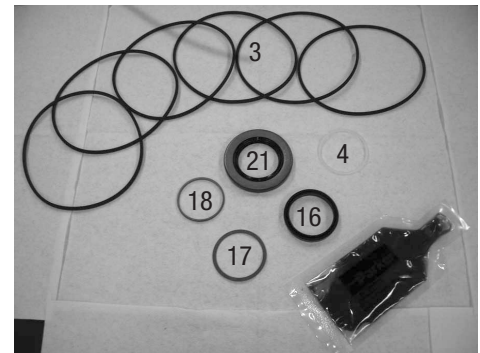

Figure 25

Place housing into soft-jawed vise

1. Clamp the housing into a soft-jawed vise or similar support, clamping against the mounting flange. SEE FIGURE 26.



Figure 26

Press in outer bearing 2. If the housing (19) bearing components were removed for replacement, thoroughly coat and pack a new outer bearing (20) with clean corrosion resistant grease recommended in the material section. Press the new bearing into the counterbore at the mounting flange end of the housing, using the appropriate sized bearing mandrel such as described in figure 1 which will control the bearing depth to .410/.420” from the outside face of the counter bore. SEE FIGURE 27.



Figure 27

NOTE **Bearing mandrel must be pressed against the lettered end of bearing shell. Take care that the housing bore is square with the press base and the bearing is not cocked when pressing a bearing into the housing.**

CAUTION **If the bearing mandrel specified in the “Tools and Materials Required for Servicing” section is not available and alternate methods are used to press in bearing (13) or (20) be careful to ensure that the bearing depths specified are achieved to insure adequate bearing support and correct relationship to adjacent components when assembled.**

CAUTION **Because bearings (13) and (20) have a press fit into the housing they must be discarded when removed. They must not be reused.**

CAUTION **The outer bearing (20) is not lubricated by the system’s hydraulic fluid. Be sure it is thoroughly packed with the recommended grease, Parker Gear grease specification #045236, E/M Lubricant #K- 70M or Mobil Mobilith SHC ® 460 A packet of grease (P/N 406018) is included in each seal kit.**

Press in dirt & water seal

3. Press a new dirt and water seal (21) into the housing (19) outer bearing counterbore. The dirt and water seal (21) must be pressed in with the lip facing out and until the seal is flush to .020 inches (.51 mm) below the end of housing. SEE FIGURE 28.



Figure 28

Place housing assembly into vise

4. Invert housing (19) assembly into a soft jawed vise or similar support with the coupling shaft bore down, clamping against the mounting flange. SEE FIGURE 29.



Figure 29

Press in inner bearing and assemble washers & seal

5. If the housing (19) bearing components were removed for replacement, press new bearing (13) into the housing (19) to a depth of .130/.150 inches. Use the opposite end of the bearing mandrel used to press in outer bearing (20). Reference figure 1, in the “Tools and Materials Required for Servicing” section. SEE FIGURE 30.



Figure 30

Assemble new backup ring (18), a new backup washer (17), new seal (16), with the lip facing to the inside of Torqmotor (see figure 45). SEE FIGURES 31 & 32.



Figure 31



Figure 32

Assemble thrust washers and thrust bearing

6. Assemble a thrust washer (14), thrust bearing (15) and a second thrust washer (14) in that order. SEE FIGURE 33.



Figure 33

CAUTION

Be sure the thrust bearing package is seated in the correct order after assembly of the new shaft seal and new backup washer and backup ring.

Apply masking tape to shaft

7. Apply masking tape around splines or keyway on shaft (12) to prevent damage to seal. SEE FIGURE 34.

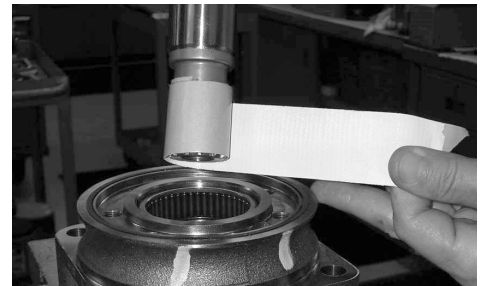

Figure 34

Install coupling shaft

8. Be sure that a generous amount of clean corrosion resistant grease has been applied to the lower (outer) housing bearing (20). Install the coupling shaft (12) into housing (19), seating it against the second thrust washer (14). SEE FIGURE 35.



Figure 35

NOTE

The coupling shaft (12) will be approximately .10 inch (2.54 mm) below the housing wear plate surface when correctly installed to allow the assembly of thrust bearing (11) and retaining washer (10). The coupling shaft must rotate smoothly on the thrust bearing package.

Install thrust bearing and retaining washer

9. Install thrust bearing (11) and retaining washer (10) onto the end of coupling shaft (12). SEE FIGURE 36.

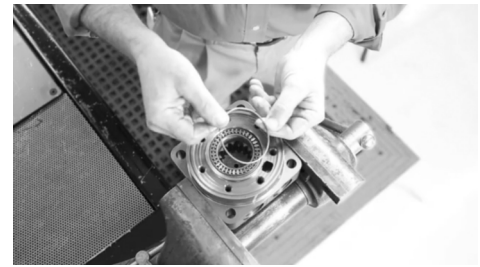

Figure 36

Insert seal ring

10. Install a new seal ring (3) into the housing (19) seal ring groove. SEE FIGURE 37.



Figure 37

Assemble wear plate and seal ring

11. Assemble wear plate (8) onto the housing (19). SEE FIGURE 38. Install a new seal ring (3) and assemble it into the seal ring groove on the wear plate.

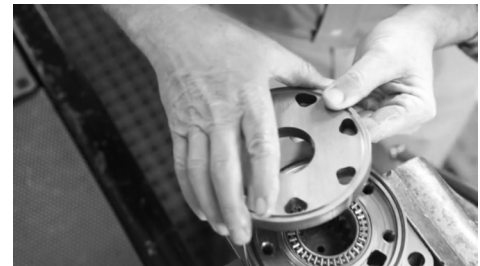

Figure 38

Install drive link

12. Install drive link (9) with the long splined end down into the coupling shaft (12) and engage the drive link splines into mesh with the coupling shaft splines. SEE FIGURE 39.

NOTE

Use any alignment marks put on the coupling shaft and drive link before disassembly to assemble the drive link splines in their original position in the mating coupling shaft splines.



Figure 39

Install the assembled rotor set and seal ring

13. Install the assembled rotor set (7) onto wear plate (8) with rotor counterbore side down and the splines into mesh with the drive link splines. SEE FIGURES 40 and 41. Install a **new** seal ring (3) and into the seal ring groove in the rotor set (7). SEE FIGURE 42.



Figure 40



Figure 41



Figure 42

NOTE

The manifold (6) is made up of several plates bonded together permanently to form an integral component. The manifold surface that must contact the rotor set has it's series of irregular shaped cavities on the largest circumference or circle around the inside diameter. The polished impression left on the manifold by the rotor set is another indication of which surface must contact the rotor set.

Install manifold and seal ring

14. Assemble the manifold (6) over the drive link (9) and onto the rotor set. Be sure the correct manifold surface is against the rotor set. SEE FIGURE 43. Install a **new** seal ring (3) and in the seal ring groove exposed on the manifold.



Figure 43

Assemble seal & commutator

15. Assemble a **new** seal ring (4) flat side up, into commutator (5) and assemble commutator over the end of drive link (9) onto manifold (6) with seal ring side up. SEE FIGURE 44.



Figure 44

Install commutator ring

16. Assemble the commutator ring (5) onto the manifold. SEE FIGURE 45. Install a **new** seal ring (3) and in the seal ring groove exposed on the commutator ring.



Figure 45

- Assemble end cover**
19. Assemble end cover (2) over the commutator and in line with the alignment marks on the exterior of the motor. SEE FIGURE 46.



Figure 46

- Assemble cover bolts**
20. Insert the bolts through the end cover until threads of each bolt reach the proper threaded hole of the housing. Hand start each bolt. Alternately and progressively tighten the bolts to pull the end cover and other components into place with a final torque of 45-55 ft. lbs. SEE FIGURES 47 and 48.



Figure 47



Figure 48

THE ASSEMBLY OF THE TORQMOTOR IS NOW COMPLETE EXCEPT FOR KEY (28), NUT (29), or OTHER EXTERNAL HARDWARE IF APPLICABLE. PROCEED TO FINAL CHECKS SECTION.

Final Checks

- Pressurize the Torqmotor with 100 PSI dry air or nitrogen and submerge in solvent to check for external leaks. Make sure to plug the remaining ports prior to submerging.
- Check Torqmotor for rotation. Torque required to rotate coupling shaft should not be more than 50 lb/ft (68 N m).
- On TGK Series Torqmotor, pressure port with "A" cast under it on endcover (2) is for clockwise coupling shaft rotation as viewed from the output end of coupling shaft. Pressure port with "B" cast under it for counter clockwise coupling shaft rotation.
- Use test stand if available, to check operation of the Torqmotor.

Hydraulic Fluids

Keep the hydraulic system filled with one of the following:

- 10W40 SE or SF, or manufacturer's suggested oil.
- Hydraulic fluid as recommended by equipment manufacturer, but the viscosity should not drop below 50 SSU or contain less than .125% zinc anti-wear additives.

 CAUTION	Do not mix oil types. Any mixture, or an unapproved oil could deteriorate the seals. Maintain the proper fluid level in the reservoir. When changing fluid, completely drain old oil from the system. It is suggested also that you flush the system with clean oil.
--	--

Filtration

Recommended filtration 20-50 micron.

Oil Temperature

Maximum operating temperature 200° F (93.3° C).

System Maintenance Tips

- Adjust fluid level in reservoir as necessary.
- Encourage all operators to report any malfunction or accident that may have damaged the hydraulic system or component.
- Do not attempt to weld any broken Torqmotor component. Replace the component with original equipment only.
- Do not cold straighten, hot straighten, or bend any Torqmotor part.
- Prevent dirt or other foreign matter from entering the hydraulic system. Clean the area around the filler caps before checking oil level.
- Investigate and correct any external leak in the hydraulic system, no matter how minor the leak.
- Comply with manufacturer's specifications for cleaning or replacing the filter.

CAUTION Do not weld, braze, solder or in any way alter any Torqmotor component.

CAUTION Maximum operating pressure must not exceed recommended Torqmotor pressure capacity.

CAUTION Always carefully inspect any system component that may have been struck or damaged during operation or in an accident. Replace any component that is damaged or that is questionable.

CAUTION Do not force any coupling onto the Torqmotor coupling shaft as this could damage the unit internally.

Parker Pump/Motor Operation extends close technical cooperation and assistance. If problems occur which you cannot solve, please contact our service department at (423) 639-8151, or your local Parker approved distributor.



Parker Hannifin Corporation
Hydraulic Pump/Motor Division
2745 Snapps Ferry Road
Greeneville, TN 37745 USA
Tel. (423) 639-8151
FAX (423) 787-2418
www.parker.com/pumpmotor