

SIEMENS



Quick start installation guide

VersiCharge™ AC

Electric vehicle charging station

[siemens.ca/versicharge](https://www.siemens.ca/versicharge)

Human Machine Interface (HMI)

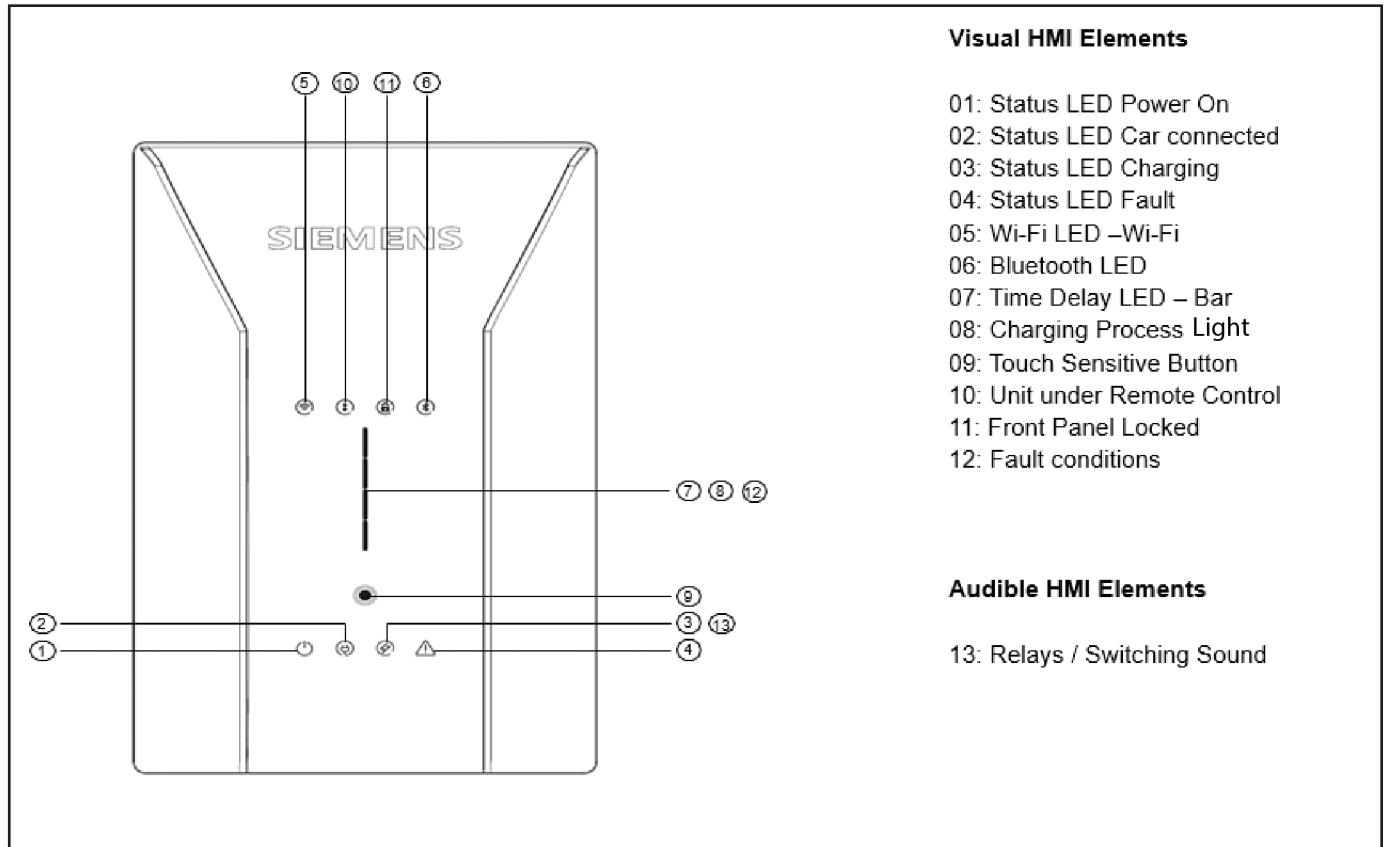

Figure 1. Residential HMI

NOTE: Number of LEDs may change based on specific part number and features.

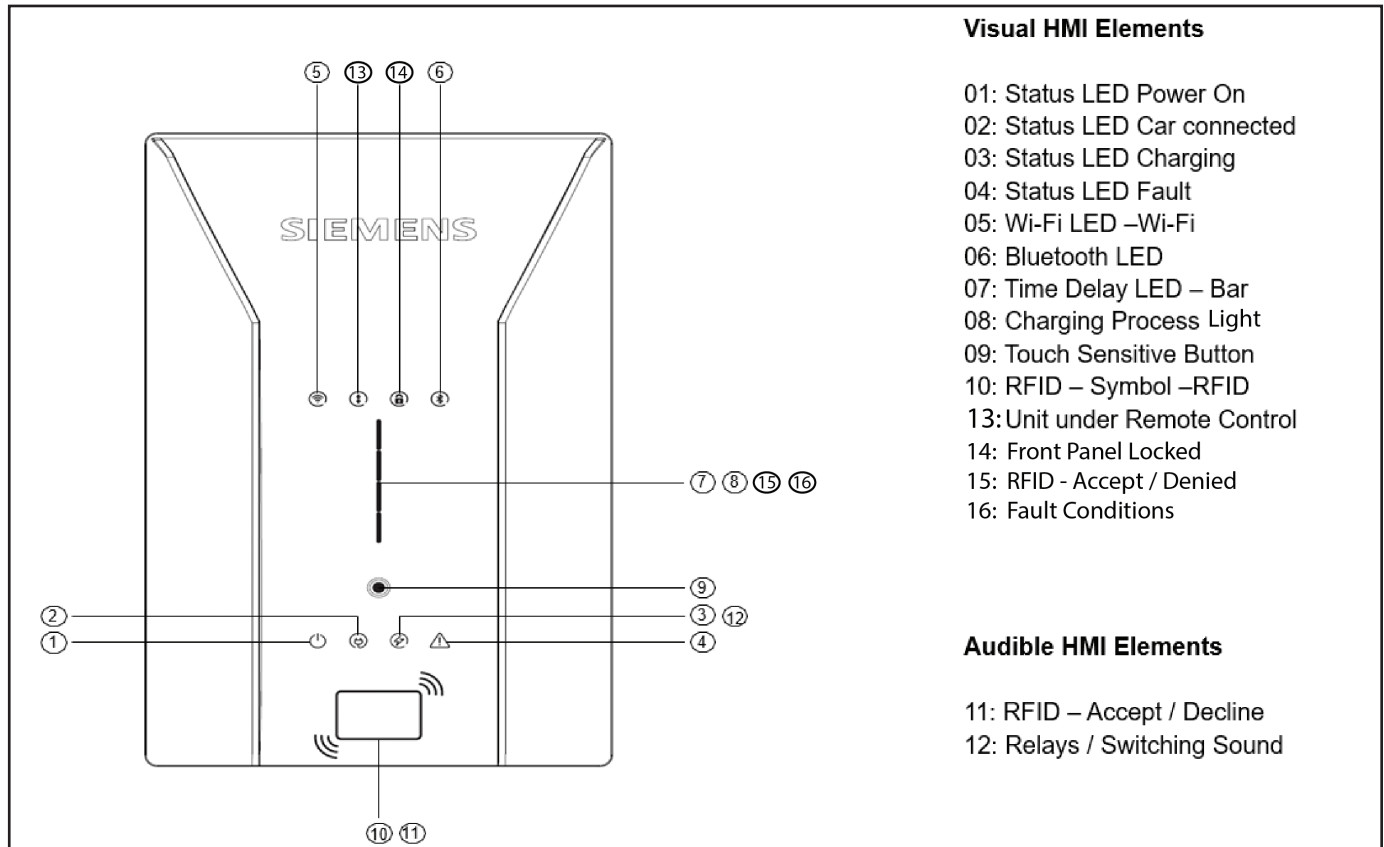



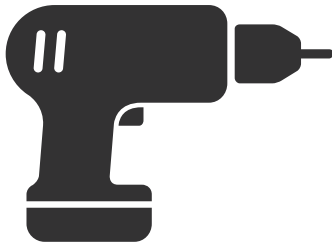
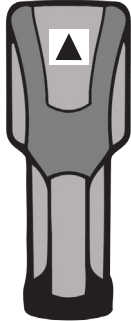
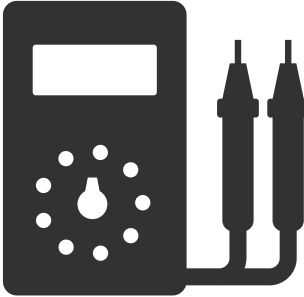
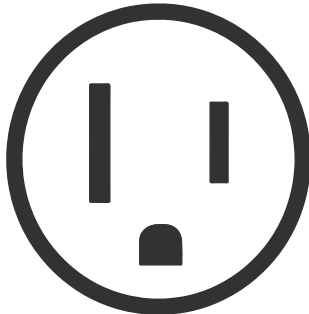

Figure 2. Commercial HMI



NOTE: Number of LEDs may change based on specific part number and features.

Installation kit

Equipment List

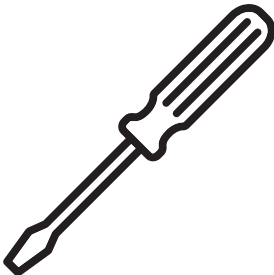
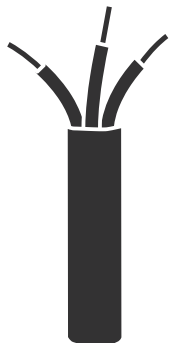
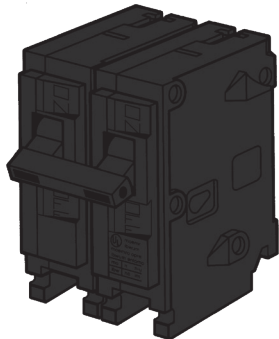
Standard Installation – What you will need:

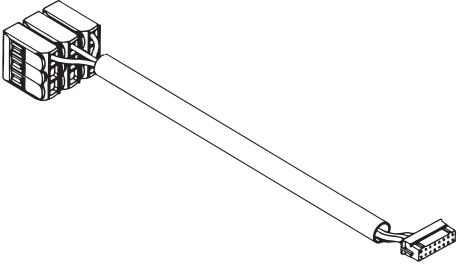
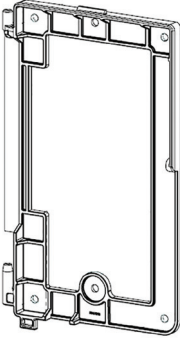
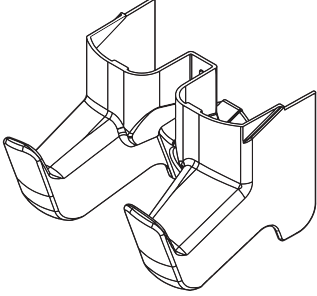
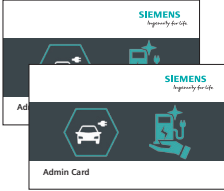
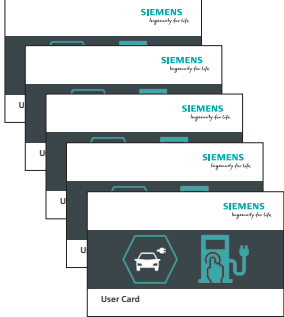
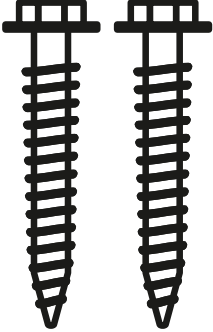
		
<p>Certified Electrician (Recommended)</p>	<p>Cordless Drill (Phillips Bit with extender)</p>	<p>Stud Finder</p>
		
<p>240 V AC Voltmeter</p>	<p>NEMA 6-50 Outlet (Only used for the 40A charger P/Ns 8EM1312-4AF10-0AA3, 8EM1312-4CF18-0FA3.)</p>	<p>7/16" Socket wrench</p>
		
<p>Screwdriver</p>	<p>#6 75C copper wire should be used for 48A charger and #8 75C copper wire should be used for a 40A charger. NOTE: 1. Wire must have a temperature rating of 75C or higher). 2. Do not set the amp switch higher than 40A unless hardwired to a dedicated 60A branch protection circuit breaker.</p>	<p>40A charger requires a 2-pole, 240V, 50A circuit breaker. 48A charger requires a 2-pole, 240V, 60A circuit breaker.</p>

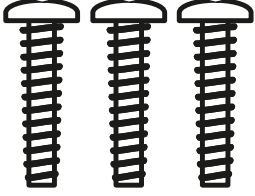
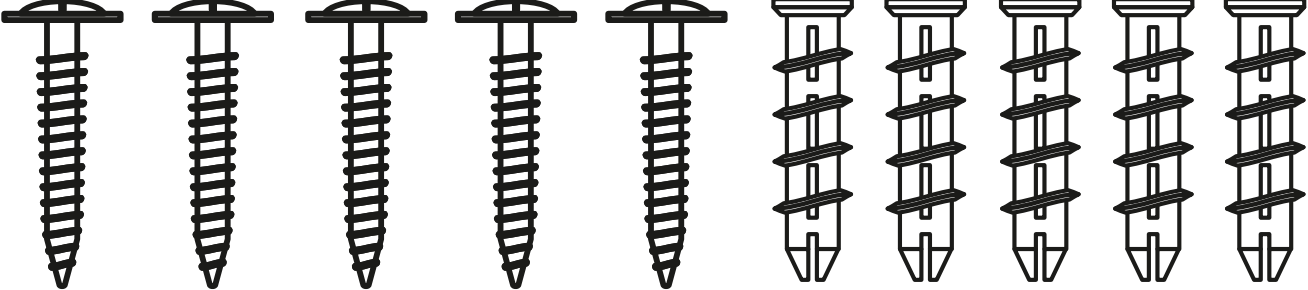
<h2>Kit Supplied Equipment</h2>			
1 – ModBus Connector			
			
1 – Mounting Bracket	1 – Cable Holster	2 – Admin Cards	5 – User cards
			
2 – Lag Screws, Hex Head screws, 1/4 x 2" (for securing the mounting bracket to the wall studs)	Tamper resistant 5/32" Allen wrench (secure the charger)	1 – #8 x 2-1/2" Flat Head Drywall Screw (for securing the holster to the wall stud)	3 – #10-32 X 3/8", Tamper Resistant, Pin-In Hex Socket Button Head Cap Screw (secure the charger)
<h3>2.3 Alternate Installation – What you will need (screws and anchors are not included in the VersiCharge installation kit):</h3>			
			
5 – #12 x 1-1/2 LG Phillips head Ø.375 head minimum, with 5 - #12 wall anchors (NOTE: wall anchors must be rated for 61 lbs. for 1/2" dry wall).			

Bracket Mounting:

STEP 1

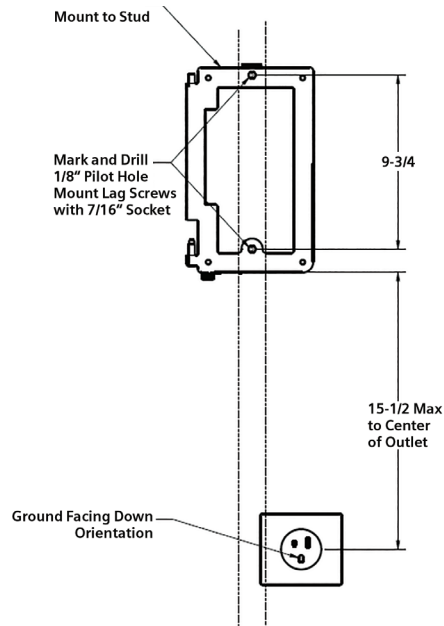

Figure 3. Bracket Position

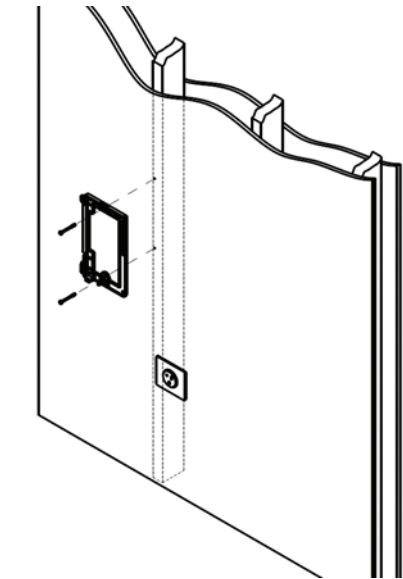

Figure 4. Wall Mounting

STEP 1A

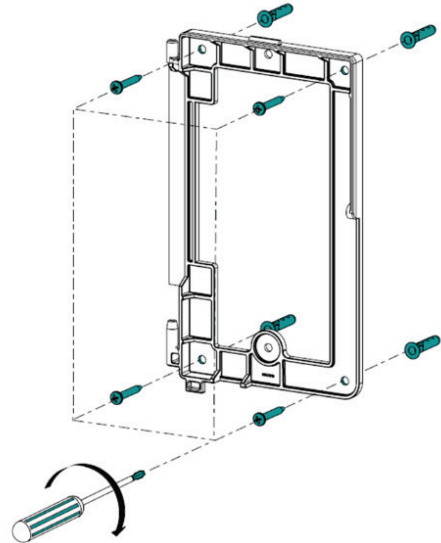

Figure 5. Alternate Bracket Mounting

Charger Mounting:

STEP 2

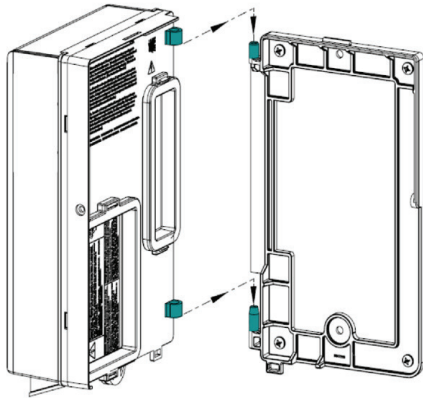

Figure 6. Hanging Charger

STEP 3

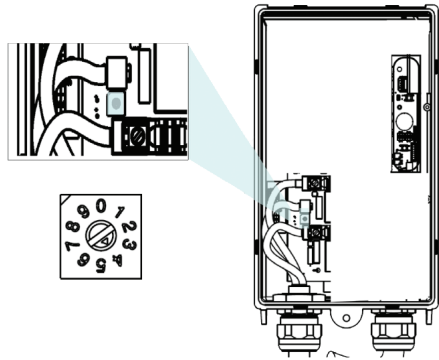

Figure 7. Amp Switch Setting

STEP 4

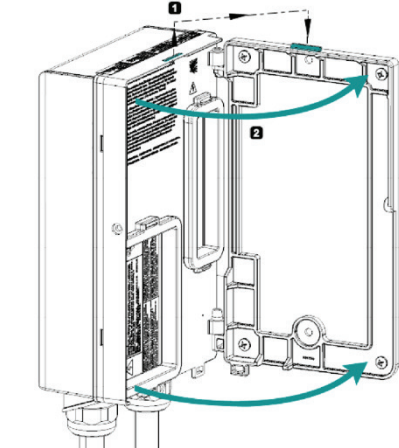

Figure 8. Close Charger

STEP 5

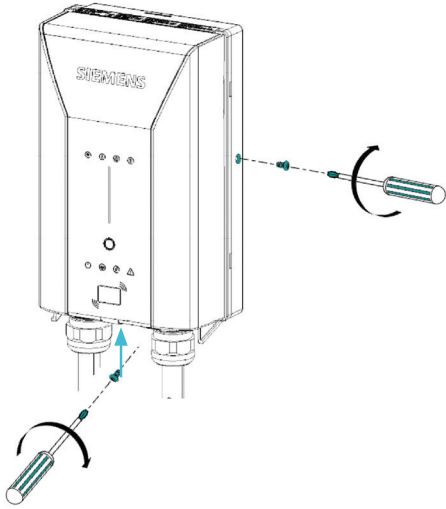

Figure 9. Secure Charger (Optional)

STEP 6

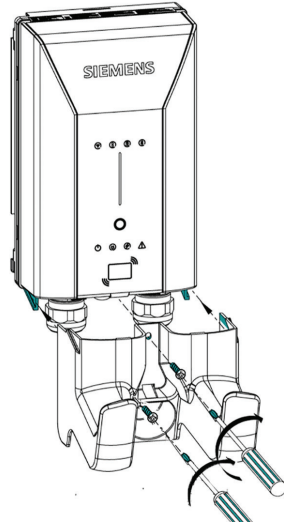

Figure 10. Holster Installation

STEP 7

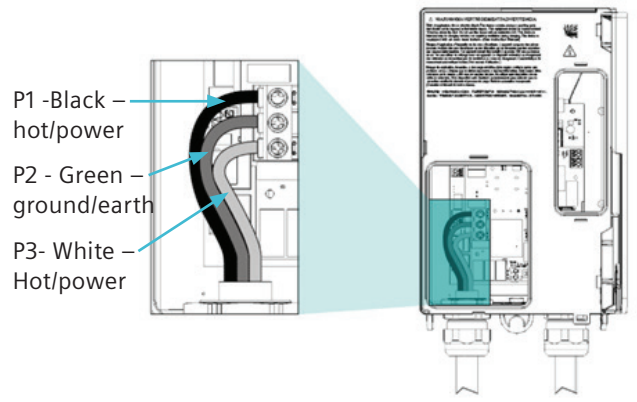

Figure 11. Charger Hardwiring
See Appendix C for wire bending diagram.

STEP 8

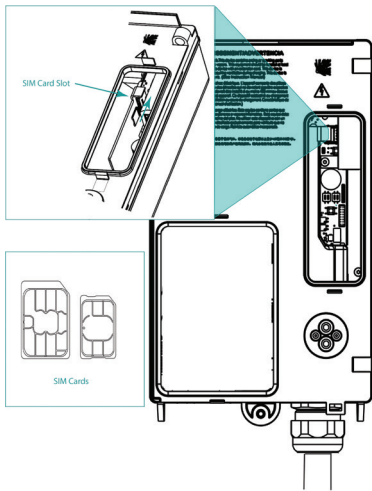

Figure 12. SIM Card Installation*

STEP 9

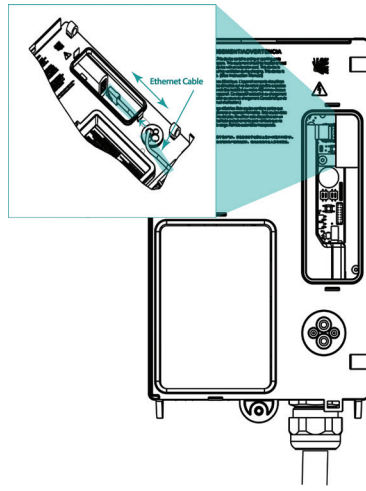

Figure 13. CAT6 Ethernet Port Connection**

STEP 10

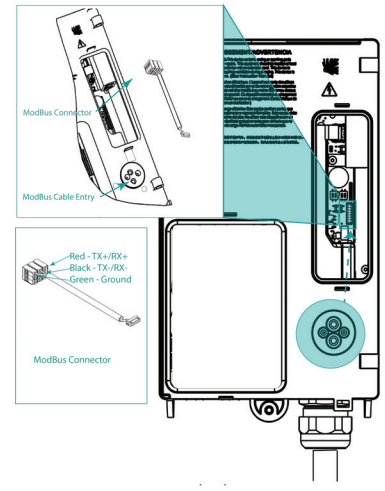

Figure 14. Serial RS485 ModBus Connection*

*This feature is only available on Commercial Units.

**This feature is available on both Residential and Commercial Units.

STEP 10A (See below for applicable part numbers)

STEP 10B (See below for applicable part numbers)

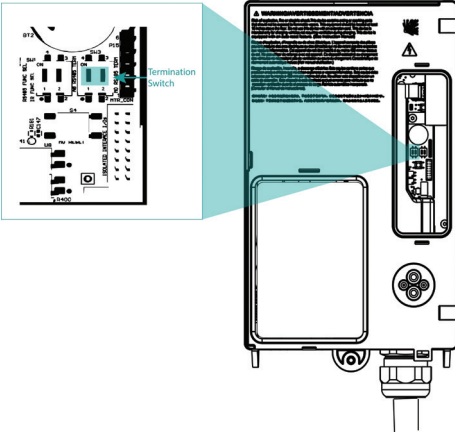
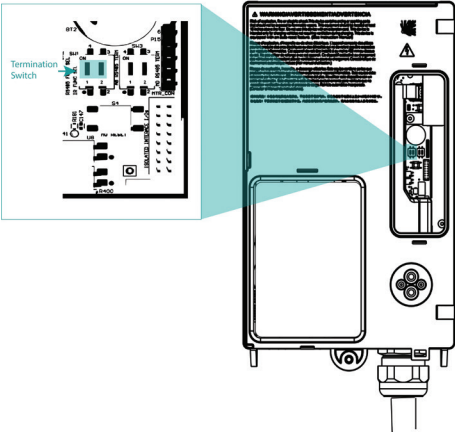

Figure 15. Commercial ModBus Termination Switch*

Figure 16. ModBus Termination Switch*

STEP 11

External Remote Control Interface

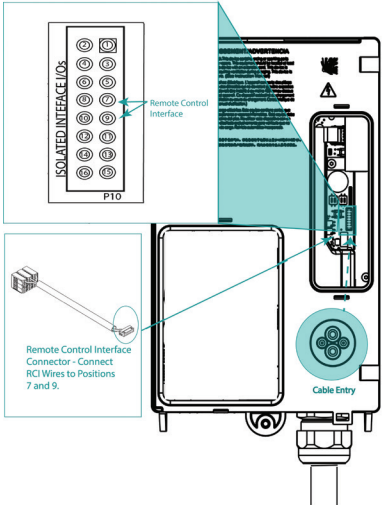



Figure 17. External Remote Control Interface**

*This feature is only available on Commercial Units.
 **This feature is available on both Residential and Commercial Units.

Optional	Outlet Installation															
STEP 1	Standard Mounting (Recommended)	<ol style="list-style-type: none"> 1. Locate a stud within the wall that can handle the 17+ lb. (7.7+ kg) load of the VersiCharge. 2. Place the mounting bracket not more than 12" (30 cm) above a 240 V outlet; level the mounting and drill the center-top hole using the drill with an extender. 3. Secure the mounting with the kit-supplied screws. 4. Drill the bottom hole using the bottom-center mounting hole as a guide. 5. Secure with the kit-supplied screw. 6. Tighten both top and bottom screws securely. <p>For concrete cinder block walls, install appropriate anchors. If using an existing outlet, ensure that power cord will reach to the outlet. Using a 7/16" socket, attach mounting bracket to wall in compliance with all Canadian Electrical Code (CEC) and local jurisdiction requirements, using the 2 lag screws provided.</p>														
STEP 1A	Alternate Mounting	<p>NOTE: Anchor Rating: 5 anchors must be rated as 61 lb. (28 kg) anchors rated for 1/2" dry wall .</p> <p>The VersiCharge can be mounted using 5 - #12 x 1-1/2 LG Phillips head 0.375 head minimum with 5 - #12 wall anchors.</p> <ol style="list-style-type: none"> 1. Locate the mounting bracket not more than 12" (30 cm) above a 240 V outlet or if hardwiring, the wiring will come through the bottom of the charger. 2. Level the mounting bracket and drill 4 holes, one in each corner of the bracket. 3. Place anchors into the wallboard until they are flush with the wall. 4. Place the mounting bracket over the holes (hinges facing upward, flat side of the bracket against the wall) with the anchors and screw the mounting to the wall securely. 5. Add a 5th hole for mounting the holster once the unit is mounted on the wall. Place the holster on the wall and mark the correct position for the hole. Refer to Step 6 and its graphic. 														
STEP 2	Install/Mount Charger	<p>NOTE: For installation, the mounting-bracket hinges will be pointing to the ceiling, and the flat side of the bracket will be against the wall.</p> <ol style="list-style-type: none"> 1. Slide the VersiCharge on to the hinges. 2. Rotate to the right until the unit clicks and is closed. 3. Secure the enclosure with the locking mechanism and plug the VersiCharge into the 240 V outlet. If hardwiring the unit, see Hardwire Installation in Step 7. 														
STEP 3	Set Amp Switch	<div data-bbox="435 1192 1075 1377" style="border: 1px solid black; padding: 5px;">  <p>DANGER Hazardous voltage. Will cause death or serious injury. Turn off power before working on this equipment. This indicates a situation where the present voltage could cause injury or death. Extreme caution is required when servicing or installing the equipment referenced.</p> </div> <p>The VersiCharge comes set to the maximum of the model purchased (i.e. a 40 amp model will not exceed 40 amps but may be derated for lower amperage by using the amperage adjustment dial). See Figure 7.</p> <p>Amperage Settings</p> <table border="1" data-bbox="435 1545 1295 1818"> <thead> <tr> <th>Switch Position</th> <th>Amps</th> </tr> </thead> <tbody> <tr> <td>0</td> <td>12</td> </tr> <tr> <td>1</td> <td>16</td> </tr> <tr> <td>2</td> <td>24</td> </tr> <tr> <td>3</td> <td>32</td> </tr> <tr> <td>4</td> <td>40</td> </tr> <tr> <td>5</td> <td>48</td> </tr> </tbody> </table> <p>NOTE: Setting the amp switch higher than #5 will cause a bad switch fault.</p>	Switch Position	Amps	0	12	1	16	2	24	3	32	4	40	5	48
Switch Position	Amps															
0	12															
1	16															
2	24															
3	32															
4	40															
5	48															
STEP 4	Close the Charger															

STEP 5	Secure Charger	<ol style="list-style-type: none"> Using the 3 - #10-32 X 3/8", Tamper Resistant, Pin-In Hex Socket Button Head Cap Screw (Tamper-resistant alternative) secure the VersiCharge cover with one screw on the right side of the VersiCharge to bolt the cover closed. Secure the holster with one screw at the top of the holster where it connects to the VersiCharge cover. For more holster installation information, see Step 6 below. Secure the cover with the third screw at the bottom of the VersiCharge just above the holster.
STEP 6	Install Cable Holster	<ol style="list-style-type: none"> Align the holes in the holster and screw securely to the wall. Place EV connector cable in the holster.
<div style="display: flex; align-items: center;">  <div style="background-color: black; color: white; padding: 5px; font-size: 0.9em;"> <p>DANGER Hazardous voltage. Will cause death or serious injury. Turn off power before working on this equipment. This indicates a situation where the present voltage could cause injury or death. Extreme caution is required when servicing or installing the equipment referenced.</p> </div> </div> <p>NOTE: Any time the interior wiring is exposed while there is power to the unit there is danger of hazardous voltage and serious injury.</p>		
STEP 7	Hardwire the VersiCharge (Skip if using an existing 240 V outlet)	<p>Open the VersiCharge and expose the wiring, unscrew the lugs and remove the plug.</p> <p>Loosen screws on lugs.</p> <p>Back out wires. Install new wiring.</p> <p>NOTE:</p> <ol style="list-style-type: none"> When installing the hardwired VersiCharge, power connections shall be made at line terminals with 14.5 in-lb. torque driver. The rating of the circuit breaker that will be required is based on the ampere rating of the EVSE; 40A requires 50A breaker, 48A requires 60A breaker. Plug removal is only necessary when hardwiring VersiCharge. When removing Stop cap to hardwire, the unit will no longer be rated NEMA 4 unless replacing the Stop cap with an approved cable gland.
STEP 8	SIM Card Installation (Commercial Units Only) Part numbers: 8EM1310-4CF14-1GA1, 8EM1310-5CF14-1GA1	<p>SIM Card General Information</p> <p>This hardware uses a micro SIM card, but with an adapter will allow nano SIM cards.</p> <p>The SIM card should NOT require a PIN. Locked SIM cards are not supported by VersiCharge hardware.</p> <p>The following carriers are supported : AT&T, T-Mobile and Rogers. Data plans should have a minimum consumption of 250 MB per month per charger</p> <p>Expose the area holding the SIM card hardware by unlatching the cover (see Figure 11). The SIM card sits next to the Ethernet connection (see STEP 9). Slide the micro SIM card into slot. (SIM card to be supplied by the service provider).</p> <p>The SIM card socket is spring loaded. Slide the SIM card from the bottom upward into the slot until it stays in place.</p> <p>To remove/replace the SIM card, press the SIM card upward and it will "spring" down and out of the slot.</p>
STEP 9	Connect Ethernet (Residential and Commercial Units) Part numbers: 8EM1312-4CF18-0FA3, 8EM1312-5CF18-0FA3, 8EM1310-4CF14-0GA0, 8EM1310-5CF14-0GA0, 8EM1310-4CF14-1GA1, 8EM1310-5CF14-1GA1	<p>NOTE: The Ethernet cable connector should NOT be on the Ethernet cable when it is pushed through the rubberized gland. This gland will not self-seal if the connector is pushed through the rubberized gland and the NEMA 4 rating will be lost.</p> <p>Push the Ethernet cable through the rubberized gland and snake it up through the back to the opening. Connect the Ethernet connector and insert the connector from the bottom up into the Ethernet connection.</p>

STEP 10	<p>Connect ModBus RS485 (Commercial Units Only)</p> <p>Part numbers: 8EM1310-4CF14-0GA0, 8EM1310-5CF14-0GA0, 8EM1310-4CF14-1GA1, 8EM1310-5CF14-1GA1</p>	<p>NOTE: The ModBus connector should NOT be on the Modbus cable when it is pushed through the rubberized gland. This gland will not self-seal if the connector is pushed through the rubberized gland and the NEMA 4 rating will be lost.</p> <ol style="list-style-type: none"> Using the supplied ModBus connector gently press the connector into place (see Figure 14). Push the external ModBus cable through the rubberized gland at the back of the charger (this will self-seal). Attach the external wires to the internal wire connector. Gently tuck the wiring into the space and secure the back of the charger. <p>Security Note: The ModBus RTU is an open protocol, and it is the responsibility of the installer to ensure the security of the wiring of these connections to prevent tampering.</p>								
STEP 10A	<p>Set ModBus Termination Switch (Commercial Units Only)</p> <p>Part numbers: 8EM1310-4CF14-0GA0, 8EM1310-5CF14-0GA0, 8EM1310-4CF14-1GA1, 8EM1310-5CF14-1GA1</p>	<p>SW3-1 (left side) labelled A8 RS485 is the Termination switch. This switch should be in the ON position for the Parent unit or in the OFF position for a Child unit, unless that Child is the last Child in the daisy chain, then it must be ON.</p> <p>NOTE: For more detail on the ModBus and the Termination Switch position settings, refer to the complete VersiCharge AC Series Installation and Operation Manual at www.usa.siemens.com/versicharge.</p>								
STEP 10B	<p>Set ModBus Termination Switch (Commercial Units Only)</p> <p>Applicable to Child units ONLY with the following part numbers: 8EM1310-4CF14-0GA0, 8EM1310-5CF14-0GA0</p>	<p>SW3-2 (right side) labelled M0 RS485 Term is the Termination switch. For the child units the Termination switch must be set to OFF, unless the unit is the last one in the daisy chain, then the switch must be set to ON.</p> <p>NOTE: For more detail on the ModBus and the Termination Switch position settings, refer to the complete VersiCharge AC Series Installation and Operation Manual at www.usa.siemens.com/versicharge.</p>								
STEP 11	<p>Connect External Remote Control Interface – (Optional) (Commercial and Residential Units)</p> <p>Part numbers: 8EM1312-4CF18-0FA3, 8EM1312-5CF18-0FA3, 8EM1310-4CF14-0GA0, 8EM1310-5CF14-0GA0, 8EM1310-4CF14-1GA1, 8EM1310-5CF14-1GA1</p>	<p>The Siemens VersiCharge has a Remote Control Interface that allows charging to be controlled by an external device. Examples include demand response switches, building automation systems, digital sensors, etc.</p> <ul style="list-style-type: none"> To wire a digital input into the dry contact in the connection area located inside of the VersiCharge, please refer to the complete VersiCharge AC Series Installation and Operation Manual at www.usa.siemens.com/versicharge for more detail. When the external contact is closed, the alternate input will control the VersiCharge, preventing it from entering the 'Charging' state. The status output is a switch that indicates charging status. When the contacts are closed, the unit is in charging state. <table border="1" data-bbox="435 1241 1073 1350"> <thead> <tr> <th>Pin #</th> <th>Label</th> <th>Description</th> </tr> </thead> <tbody> <tr> <td>7</td> <td>Utility_1</td> <td rowspan="2">Utility lockout (dry contact input; locked when closed)</td> </tr> <tr> <td>9</td> <td>Utility_2</td> </tr> </tbody> </table>	Pin #	Label	Description	7	Utility_1	Utility lockout (dry contact input; locked when closed)	9	Utility_2
Pin #	Label	Description								
7	Utility_1	Utility lockout (dry contact input; locked when closed)								
9	Utility_2									
STEP 12	<p>Check the System</p>	<p>Turn the power on; the white Power Available light should illuminate. If it does not, verify that the outlet or wire is putting out 240 or 208 V using the voltmeter.</p> <p>With the Power Available light on, plug the Electric Vehicle Supply Equipment (EVSE) cable into the car. If you have any fault lights, please see the HMI figures in the beginning of this manual.</p> <p>Siemens VersiCharge Mobile App: Download the VersiCharge mobile app to your smartphone to get started using your charger. Find these applications at either Google Play (https://play.google.com/store), or iOS stores (https://www.apple.com/ios/app-store/).</p> <p>Siemens Commercial Charger Configuration Tool (PC App): Download the Configuration Tool (PC application) to configure and manage your commercial charger at www.usa.siemens.com/versicharge.</p>								

Maintenance

While there is no maintenance for the internal works of the VersiCharge, the exterior does require some basic, common sense maintenance. The following maintenance can be performed by the owner/user. All other service must be conducted by qualified personnel.

If there is any damage to the charger, contact your supplier.

General exterior maintenance is recommended to be performed every six months depending on the environment. In harsh environments, maintenance should be performed more often.

General exterior maintenance

Regular cleaning is recommended to avoid accumulation of debris/dust/dirt on or around the unit. Wipe surfaces with a soft cloth dampened with water, or for harder to removed marks, use an alcohol based cleaner. Do not spray with high pressure cleaning hoses or use abrasive chemicals.

General external checks

Check for cuts, cracks, damage, and debris. If debris is present, remove it. If you find damage, contact your supplier.











Check for damage and corrosion. If present, contact your supplier.

























Check the HMI for damage/signs of faded color that is clearly visible.

Ensure there is no debris or damage inside or around the cable, cable holder and connector/plug. If present, remove debris and/or notify the supplier of any damage. Check the connector/plug pins for any signs of corrosion and contact the supplier, if there is any damage to the pins.

Check for snow buildup around the VersiCharge and clear the area around the VersiCharge. This should be checked daily in areas with high snowfall.

APPENDIX A.- System Operation/Faults

Light State	Description	Solution
Normal Operation		
Light #1 	#1 Ready to Charge – Power On – light steady white	Connect EV. Begin charge.
Light #2 	#2 Car Connected - Light steady white	Disconnect the EV connection cable.
Light #5 	#5 Wi-Fi Status – No Wi-Fi- Light flashing red	Check router.
Light #5 	#5 Wi-Fi Status – Wi-Fi Weak – Light flashing orange	Consider using a Wi-Fi extender to boost the signal.
Light #5 	#5 Wi-Fi Status - Wi-Fi Strong – Light flashing green	No Action
Light #7 	#7 Time Delay Light - Delay 2 hours – Light flashing white	Wait for charge.
Light #7 	#7 Time Delay Light - Delay 4 hours – Light flashing white	Wait for charge
Light #7 	#7 Time Delay Light - Delay 6 hours – Light flashing white	Wait for charge
Light #7 	#7 Time Delay Light - Delay 8 hours – Light flashing white	Wait for charge
Light #9 	#9 – Touch Sensitive Button – Press Button for 5 seconds to maximize power level.	Cancel the remote power setting by pressing button 5 seconds continuously and maximizes Power.

Light State	Description	Solution
Faults		
Light #9 	#9 – Touch Sensitive Button – Reset Ground Fault – Press once to reset the unit.	The unit is in a fault state. Press one time to reset the ground fault.
Light #4 	#4 Fault occurring – Light flashing red	Power cycle/turn breaker off and then on
Light #4  Light #7 	#4 + #7 (4 hr. delay light) – Lights steady red	Call Tech Support
Light #4  Light #7 	#4 + #7 (2 hr.+4 hr. delay light) – Both lights are steady red	Call Tech Support
Light #4  Light #7 	#4+ #7 (2 hr. delay light) – Fault occurring	Call Tech Support
Light #4  Light #7 	#4+ #7 (2 hr. + 6 hr. delay light) – Fault occurring	Call Tech Support
Light #4  Light #7 	#4+ #7 (2 hr.+ 8 hr. delay light) – Fault occurring	Call Tech Support
Light #4  Light #7 	#4+ #7 (2 hr. + 4 hr. + 6 hr. +8 hr. delay light) – Fault occurring	Call Tech Support
Light #4  Light #7 	#4+ #7 (4 hr. delay light) – Fault occurring	Call Tech Support
Light #4  Light #7 	#4+ #7 (4 hr. + 6 hr. delay light) – Fault occurring	Call Tech Support
Light #4  Light #7 	#4+ #7 (6 hr. delay light) – Fault occurring	Call Tech Support
Light #4  Light #7 	#4+ #7 (8 hr. delay light) – Fault occurring	Call Tech Support
Light #4  Light #7 	#4+ #7 (4 hr. + 6 hr. +8 hr. delay light) – Fault occurring	Call Tech Support

Steady light – Flashing light – Touch Sensitive Button - **NOTE:**

Light #1 is the Power Status LED.

Light #2 is the Car Connected Status LED.

Light #5 is the WI-Fi LED status.

Light #4 is the LED Fault light.

Light #7 is the Time Delay LED Light bar with 2, 4, 6, and 8 hour delay lights – some combination of lights 4 and 7 indicate the fault.

Light #9 is the Touch Sensitive Button.

APPENDIX B – Useful Links

Find the following at: usa.siemens.com/versicharge

- Register your VersiCharge
- Download the VersiCharge Configuration Tool (PC application)
- Configure your VersiCharge
- VersiCharge Frequently Asked Questions
- Detailed VersiCharge Installation and Operating Manual, as well as all legal and warranty information.

Appendix C - Hardwire Bending Diagram

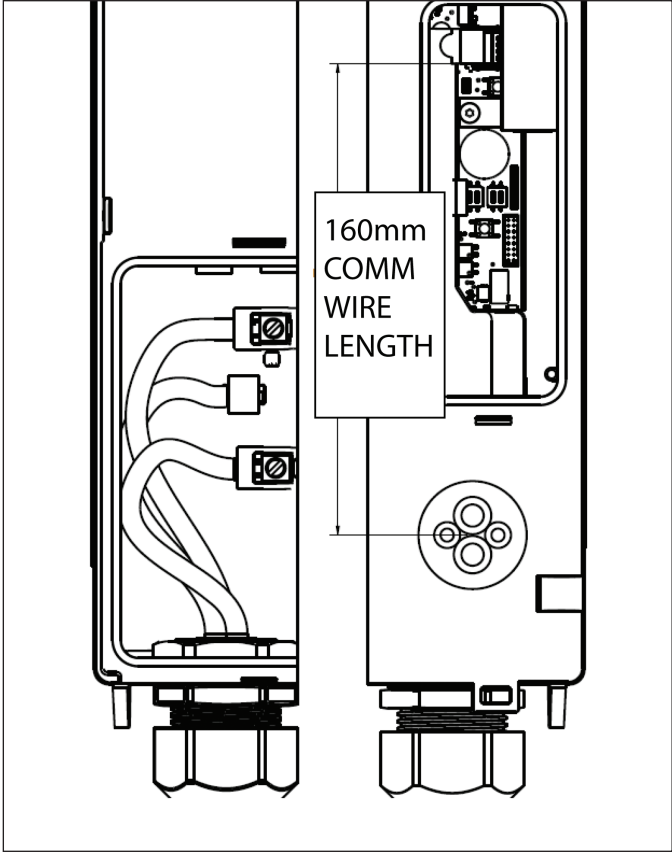

Published by Siemens Canada Limited 2021

Siemens Canada Limited
Electrical Products
1577 North Service Road East
Oakville, ON L6H 0H6

Customer Interaction Centre
(888) 303-3353
cic.ca@siemens.com

Printed in Canada.
©2021 Siemens Canada Limited
Order No.: SI-EP-1738
siemens.ca/versicharge

The technical data presented in this document is based on an actual case or on as-designed parameters and, therefore, should not be relied upon for any specific application and does not constitute a performance guarantee for any projects. Actual results are dependent on variable conditions. Accordingly, Siemens does not make representations, warranties, or assurances as to the accuracy, currency or completeness of the content contained herein. If requested, we will provide specific technical data or specifications with respect to any customer's particular applications. Our company is constantly involved in engineering and development. For that reason, we reserve the right to modify, at any time, the technology and product specifications contained herein.