

ABB MEASUREMENT & ANALYTICS | DATA SHEET

AP300

Combination pH/Redox (ORP) sensors



Measurement made easy

A reliable economic solution for a wide range of applications

Long life

- large PTFE junction provides resistance to fouling
- double junction with gelled electrolyte provides better-defined junction potentials, creating an inherently-stable reference junction that is resistant to poisoning

High accuracy

- specially formulated, low sodium-error glass for accuracy at high pH
- temperature sensor positioned perfectly to compensate for measurement and reference element temperature, ensuring rapid compensation and process temperature tracking

High reliability

- operates up to 105 °C (221 °F) and 6 bar (90 psi) @ 25 °C (77 °F)
- fouling-resistant flat glass available

High flexibility

- suitable for a wide range of applications
- available for insertion, immersion, flow-through and hot-tap
- standard- and blue-glass options
- bulb and flat-glass options

Economical

- cost-effective
- long life
- highly reliable

Introduction

ABB provides an unrivalled range of dedicated pH/Redox (ORP) sensors for a wide range of industrial duties.

The AP300 range of pH/Redox sensors offers a reliable and cost-effective solution for most industrial pH applications. It is the perfect starting point for pH or Redox measurements.

Combining measurement, reference and temperature compensation elements in a single unit, the AP300 is an economical solution for a wide variety of industrial applications; including water, food, pharmaceutical and chemical.

The AP300 probe is available in three different body types enabling the sensor to be used in immersion, insertion/flow-through and hot-tap applications.

The 'Hot-tap' sensor variant enables fitting and retraction through a standard, full-port ball-valve keeping maintenance costs to a minimum.

Robust design, maximum protection

The electrolyte is a highly resistant gel, faced with a large area, dirt-resistant PTFE junction. These are encapsulated in a robust body, providing maximum resistance to chemical attack. The sensor can withstand operating conditions up to 105 °C and 6 bar @ 25 °C (221 °F and 90 psi @ 77 °F).

Insertion, flow-through, immersion (dip) and hot-tap

AP301

General-purpose in-line/immersion, twistlock sensors.

The AP301 is a PPS (Ryton) sensor for general applications that can be adapted to 1 in. NPT fittings using threaded twistlock process adapters. Dip-type immersion is achieved using an immersion guard and connection of the 3/4 in. NPT back-thread to a customer-supplied dip-tube.



AP301 sensor with optional immersion guard

For flow-through applications, a flow cell can be fitted with either 1 in. BSP (part no. 7670043) or 1 in. NPT (part no. 7670046) threaded process connections.

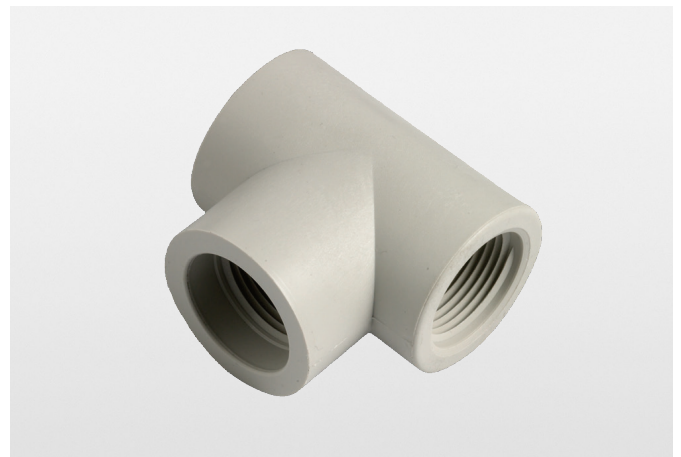

Optional flow cell (flow-through)

...Insertion, flow-through, immersion (dip) and hot-tap

AP302 and AP303

General-purpose insertion, flow-through, immersion, 3/4 in. NPT threaded sensors.

The AP302 and AP303 are constructed from PVDF (Kynar) and can be used in insertion, flow-through or immersion (dip) applications.

AP302 models have no sensor guard (flush) for use with flat glass to provide a flow-cleaned configuration.

AP303 models have a notched sensor guard to protect the bulb glass.



AP303 notched sensor

Flat / Notched sensor

Notched sensors are provided to protect the bulb glass and are especially suited to retractable and immersion sensors.

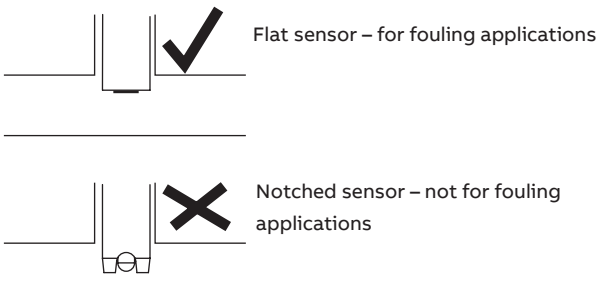

Applications for sensor styles

AP304 and AP305

General-purpose, hot-tap retractable sensors.

Completing the series, the AP304 and AP305 are fully-retractable PVDF stainless steel-clad sensors. With these sensors, project and maintenance costs can be reduced significantly as the need for expensive by-pass systems or long immersion sensors are eliminated.

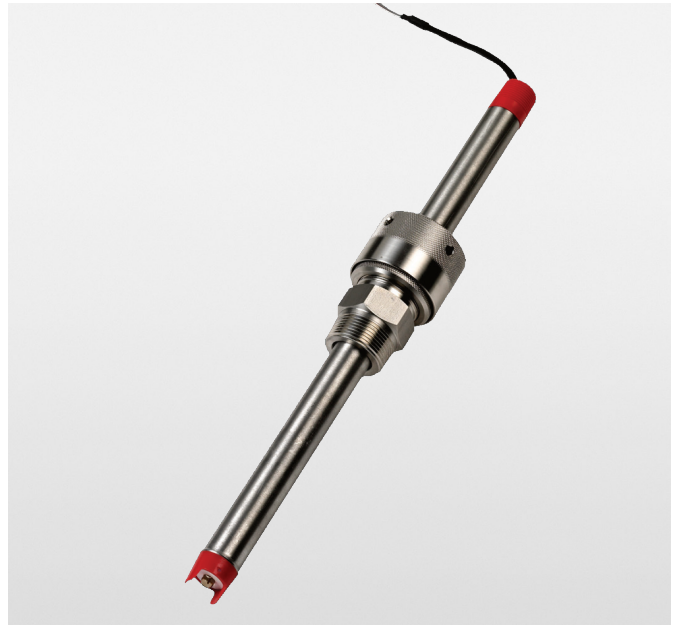

Hot-tap retractable sensor

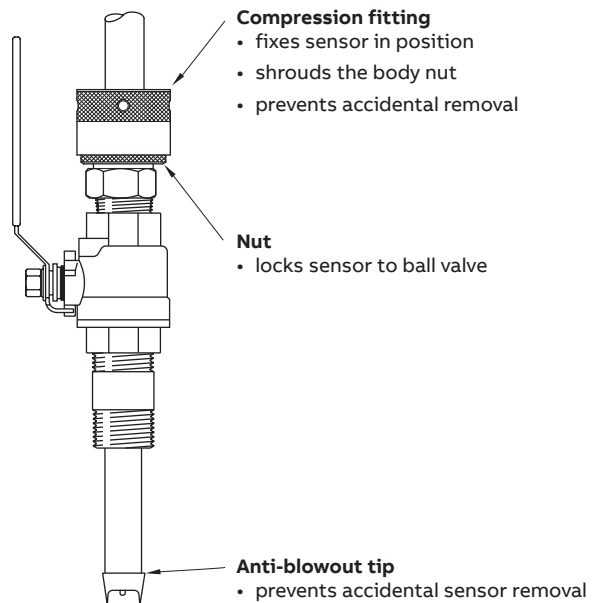

AP304 and AP305 anti-blowout tip and hand-compression fitting safety features

Hot-tap sensor

The safety of operators is paramount. This is maintained by incorporating an anti-blowout tip in the design of the AP304 & AP305; preventing accidental sensor removal. Unlike chain restraints, this safety-by-design is an integral part of the sensor's construction.

Ball-valve connection is achieved with either wrench or hand fittings. The hand compression fitting provides additional safety through two separate locking rings. A body nut union ring locks the sensor to the ball valve and enables sensor dismounting without complete disassembly. In addition, a compression ring fixes the sensor into position at the required insertion depth and seals the body from the process. This compression ring has an integral shroud that prevents access to the smaller body nut when the compression ring is loosened for sensor maintenance.

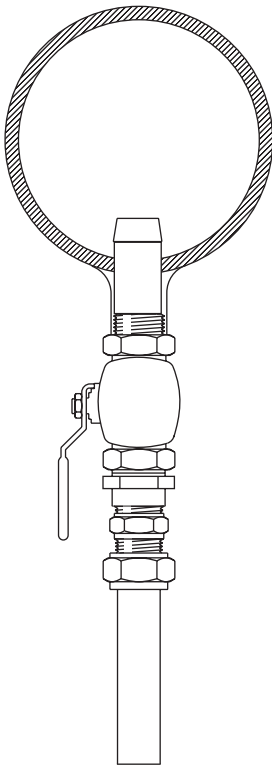

AP304 Hot-tap sensor – typical installation

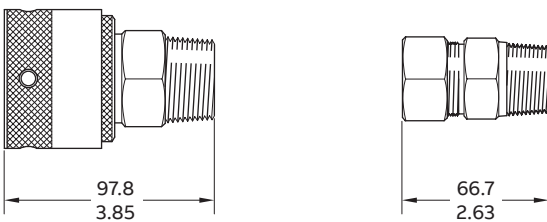

AP304/5 compression fittings



AP305 hot-tap sensor

Double junction for long life

To maximize the life-span of the sensor, the AP300 features an inherently-stable, double junction arrangement. In addition, the sensor is designed to resist poisoning in two ways, by:

- effectively doubling the length of the diffusion path between the PTFE interface and the electrode, so any poisoning from the sample takes longer to reach it.
- discouraging any movement of the reference gel around the electrode by enclosing it in a glass tube open only at the top.



Double junction construction

Temperature compensation

The AP300's temperature compensator offers fast response and high accuracy. The temperature sensor is located at the tip of the AP300, together with the measuring and reference electrodes. This arrangement provides accurate process temperature measurement used to compensate for the effects of temperature on the electrodes to produce a precise pH measurement.

The temperature compensator is available as Balco 3k or Pt100.

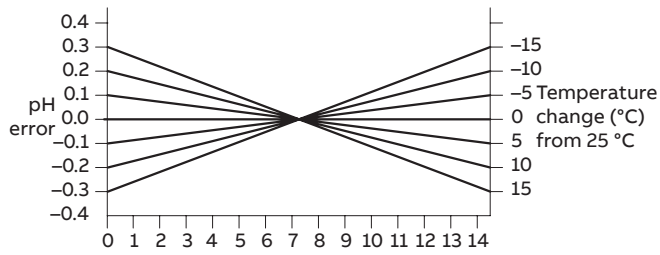

Temperature compensation

Glass options

The AP300 range is available with ABB's specially formulated standard pH-sensitive glass or, optionally, with low-resistance glass that speeds up the response of the sensor by an order of magnitude at temperatures below 60 °C (140 °F). For applications with higher pH levels and temperatures, ABB's standard glass offers a much lower sodium error than competing products; enabling the sensor to maintain its accuracy even at very high pH levels, when sodium ions would otherwise cause inaccurate readings.

Sodium error at 25 °C (77 °F): 0.02pH in 1M NaOH



ABB-manufactured electrodes

Flat-glass

The flat end and glass design promotes self-cleaning and provides maximum resistance to fibrous build-up.

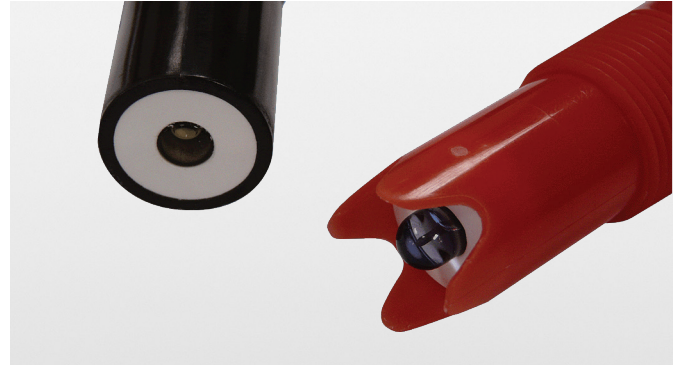

Flat and bulb glass variants

Cable options

Several connections are possible from the probe. An integral cable with tagged pins for direct connection to a transmitter or a male BNC connector for connection to an extension cable. Both tagged and BNC cables are available in versions that accommodate temperature signals. Cables are available in short, junction box-only lengths and in 5, 10, 20 and 30 m (16, 33, 66 and 98 ft.) lengths.

Without temperature compensator

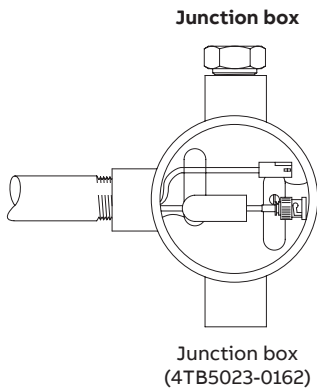
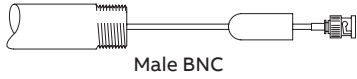

With temperature compensator

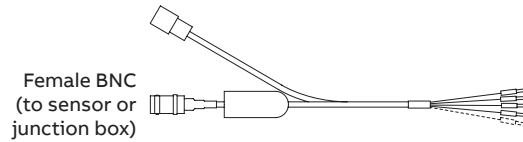
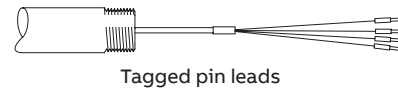
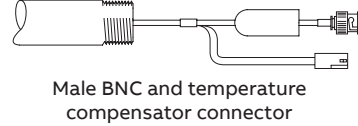

Tagged pin extension cable
5-core to AX400:
1015 160 5 m
1015 161 10 m
1015 162 20 m
1015 163 30 m

Overall dimensions

AP301

Dimensions in mm (in.)

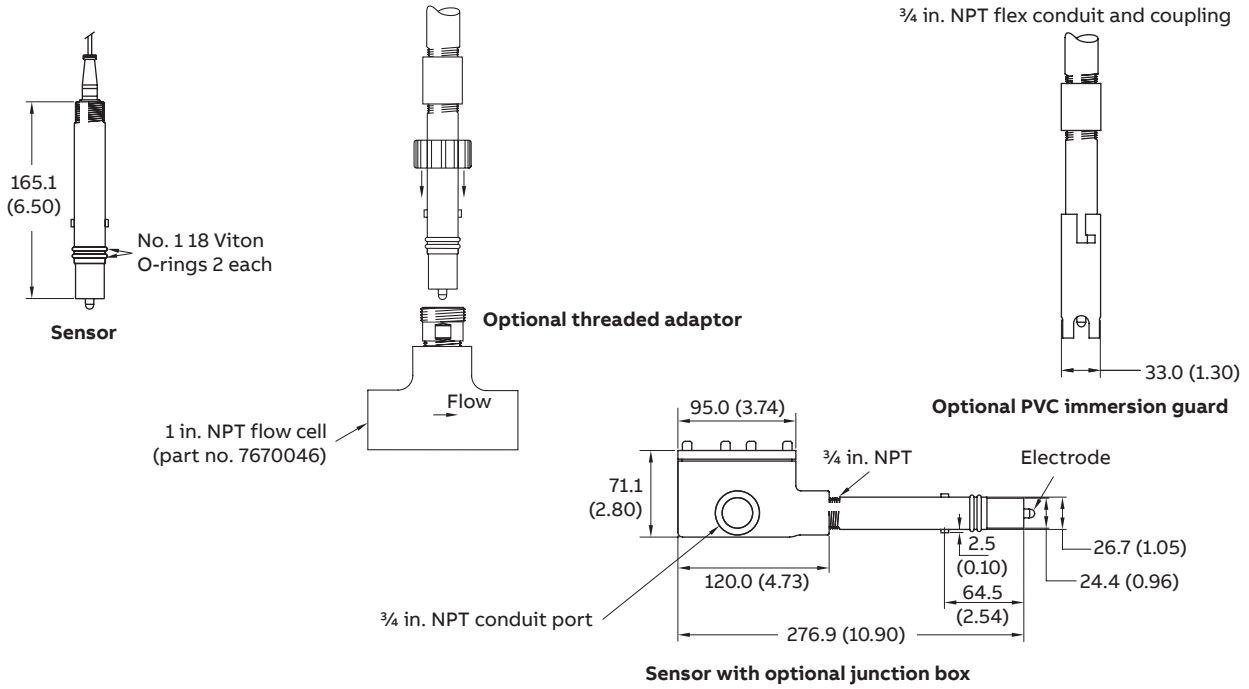

AP302 and AP303

Dimensions in mm (in.)

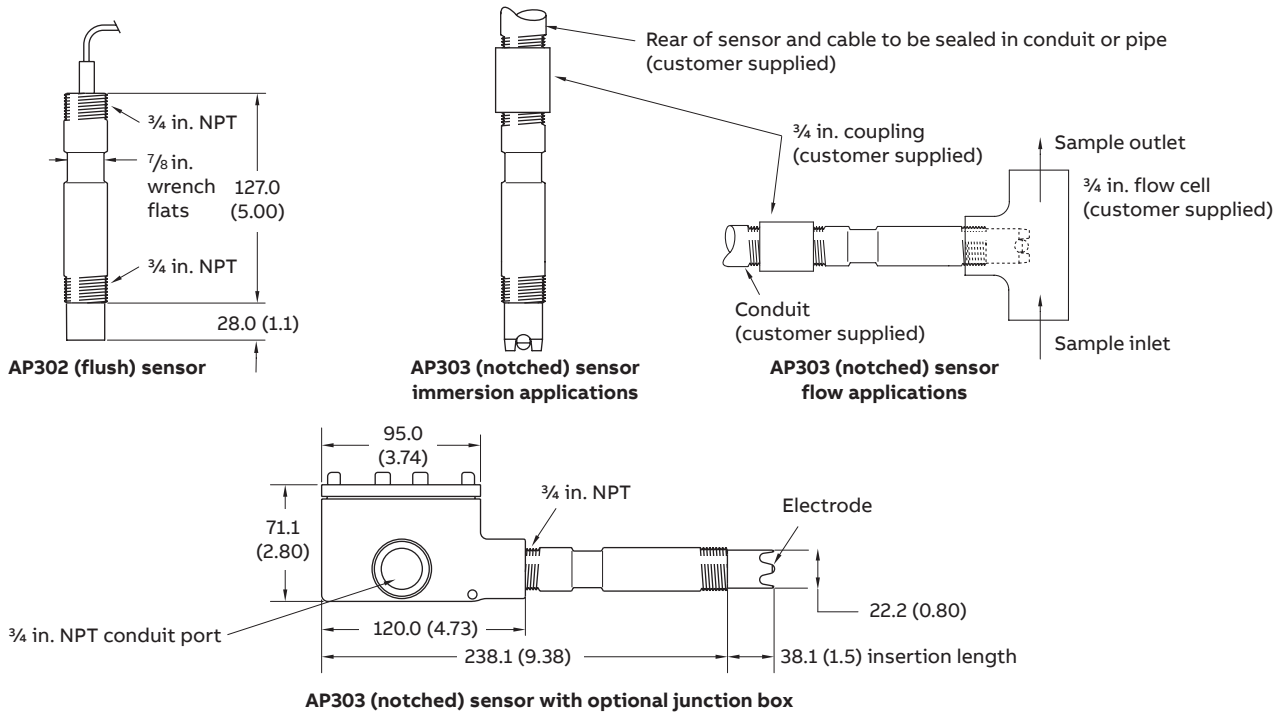

AP304 and AP305

Dimensions in mm (in.)

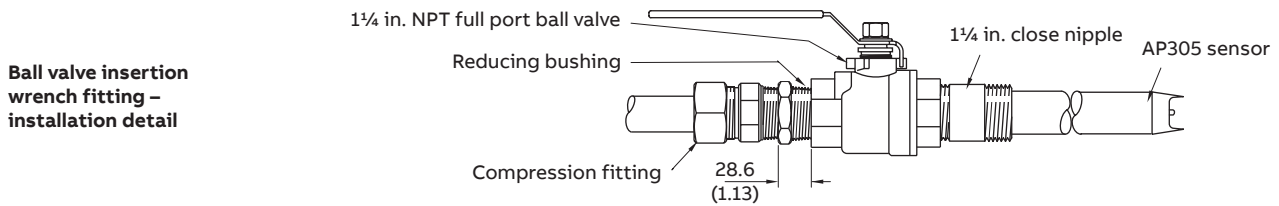
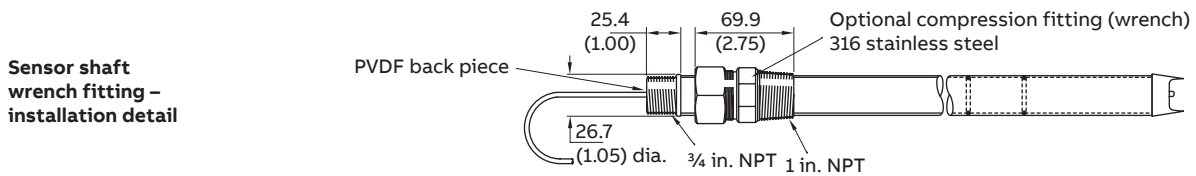
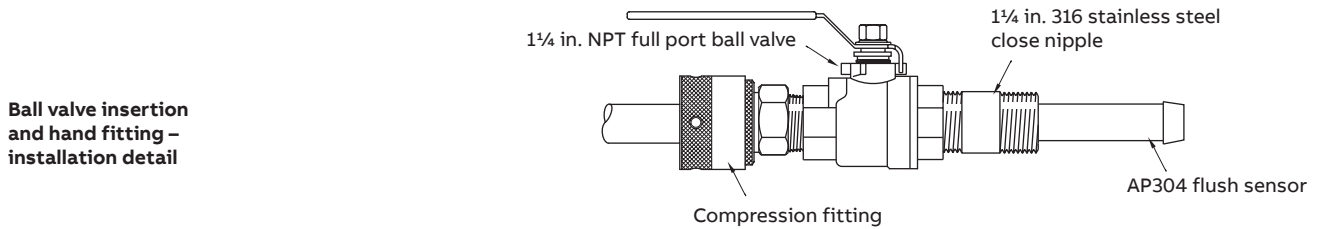
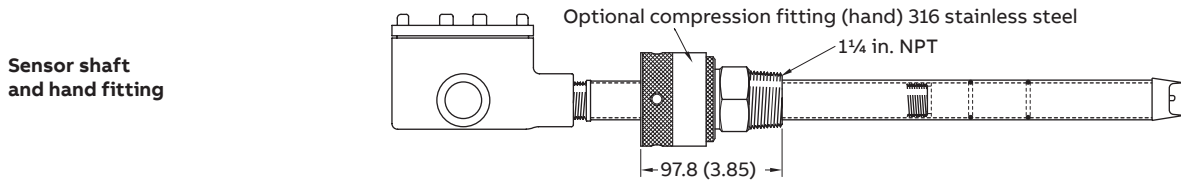
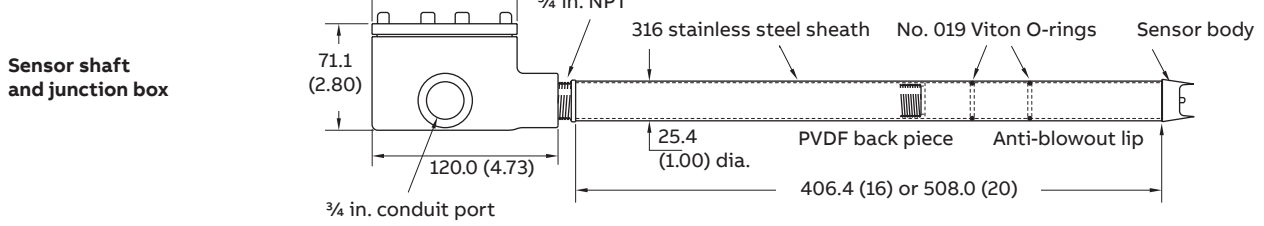
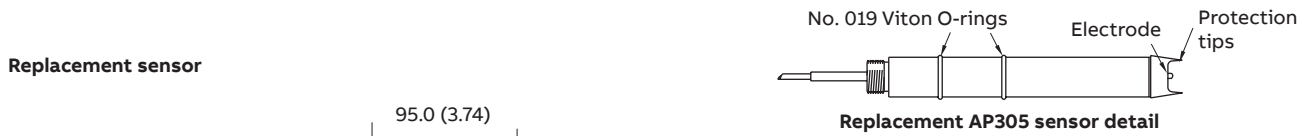
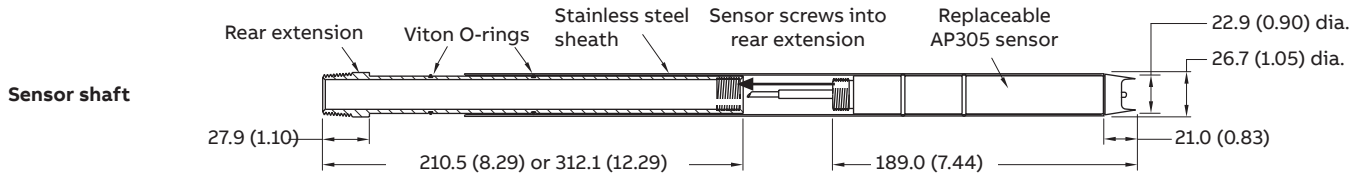

Specification

General

pH measuring range

- Standard (yellow glass) 0 to 14 pH
- Low temperature (blue glass) 0 to 10 pH

Redox (ORP) measuring range

–2000 to 2000 mV

Temperature range

- Body 0 to 105 °C (32 to 221 °F)
- Bulb glass 0 to 105 °C (32 to 221 °F)
- Flat glass 5 to 100 °C (41 to 212 °F)
- Blue glass –5 to 60 °C (23 to 140 °F)
- Redox (ORP) 0 to 105 °C (32 to 221 °F)

Pressure maximum

6 bar (90 psi) @ 25 °C (77 °F)

Temperature compensator (pH sensors only)

Integral Pt100 or Balco 3 kΩ

Wetted materials

- pH electrode Glass
- Redox (ORP) electrode Platinum
- Junction PTFE
- Body AP301 PPS (Ryton)
- Body AP302/3 and AP304/5 PVDF (Kynar)
- Flow cell PVC
- Immersion guard PVC
- AP304 and AP305 shaft and valve Stainless steel

pH glass types

- Bulb general duties
- Flat in-line, self-cleaning
- Blue low temperature

Reference system

Ag/AgCl-3.5M KCl in gel matrix

Reference junction

Porous PTFE

Spares and accessories

Threaded lock-nut adapter, PPS (Ryton)
(1 in. NPT) 4TB9515-0120

PVC Immersion / dip guard 4TB5205-0120

Junction box (requires cable gland) 4TB5023-0162

Cable gland 4TB9515-0244

Flow cells

1 in. NPT (for adapter) + 7670 046

1 in. NPT (for process connection)

1 in. NPT (for adapter) + 7670 043

1 in. BSPT (for process connection)

Flow cell pipeline adapters

1 in. BSPT to ½ in. BSPT polypropylene 7601 420

1 in. BSPT to ½ in. NPT polypropylene 7601 430

Extension cables

Tagged pin extension cables

(5-core 1015/16X for AX460 and AX466)

5 m (16 ft) 1015 160

10 m (33 ft) 1015 161

20 m (66 ft) 1015 162

30 m (98 ft) 1015 163

Buffer sachets (box of 25)

4 pH 0400/110

7 pH 0400/120

9 pH 0400/130

Buffer sachets (mixed box of 10 of each)

4, 7 and 9 pH 0400/135

Ordering information – sensor system

	AP30	X	/	X	X	0	X	X	XX	X
pH/Redox (ORP) sensor assembly										
Gel-filled, disposable sensor with dirt-repellent PTFE junction										
Body style										
Twist-lock insertion / immersion (TB551 style):										
Standard insertion – no sensor guard (flush)		1								
¾ in. threaded insertion / immersion (TB556 style):										
Insertion depth 28 mm (1.1 in.) – no sensor guard (flush)		2								
Insertion depth 38 mm (1.5 in.) – notched sensor guard		3								
Hot-tap ball valve insertion (TB557 style):										
No sensor guard (flush)		4								
Notched sensor guard		5								
Measuring electrode										
Flat glass pH for in-line, fouling applications (5 to 100 °C [41 to 212 °F], 0 to 14 pH)					1					
Standard yellow glass, pH (0 to 105 °C [32 to 221 °F], 0 to 14 pH)					2					
Low resistance blue glass, pH (-5 to 60 °C [23 to 140 °F], 0 to 10 pH)					3					
Platinum, Redox (ORP)					5					
Integral temperature sensor										
None – Redox (ORP) sensors only						0				
Pt100 – pH sensors only						1				
3 kΩ – pH sensors only						2				
Liquid junction										
PTFE							0			
Junction box or integral cable length										
Short length cable – supplied without junction box								0		
3 m (10 ft)								1		
6 m (20 ft)								2		
9 m (30 ft)								3		
Integral junction box supplied with short length cable								8		
Sensor connectors										
Tagged pin leads – all tagged terminations									0	
Connectors – BNC on pH/Redox (ORP) + temperature compensator connector (if used)									1	
Also select for electrodes used with junction box										
Accessory hardware										
No accessory supplied										00
For AP301:										
1 in. NPT, twist-lock adapter – Ryton (PPS)										12
PVC immersion (dip) guard										13
For AP304 & AP305:										
406 mm (16 in.) stainless steel sheath										20
406 mm (16 in.) stainless steel sheath and 316 stainless steel wrench fitting										21
406 mm (16 in.) stainless steel sheath and 316 stainless steel hand fitting										22
508 mm (20 in.) stainless steel sheath										23
508 mm (20 in.) stainless steel sheath and 316 stainless steel wrench fitting										24
508 mm (20 in.) stainless steel sheath and 316 stainless steel hand fitting										25
Instruction manual										
English										1
French										2
German										3
Spanish										4



ABB Limited**Measurement & Analytics**

Oldends Lane, Stonehouse
Gloucestershire, GL10 3TA
UK

Tel: +44 (0)1453 826 661

Fax: +44 (0)1453 829 671

ABB Inc.**Measurement & Analytics**

125 E. County Line Road
Warminster, PA 18974

USA

Tel: +1 215 674 6000

Fax: +1 215 674 7183

abb.com/measurement

We reserve the right to make technical changes or modify the contents of this document without prior notice. With regard to purchase orders, the agreed particulars shall prevail. ABB does not accept any responsibility whatsoever for potential errors or possible lack of information in this document.

We reserve all rights in this document and in the subject matter and illustrations contained therein. Any reproduction, disclosure to third parties or utilization of its contents – in whole or in parts – is forbidden without prior written consent of ABB.