

ABB MEASUREMENT & ANALYTICS | OPERATING INSTRUCTION

# SCC-K Converter

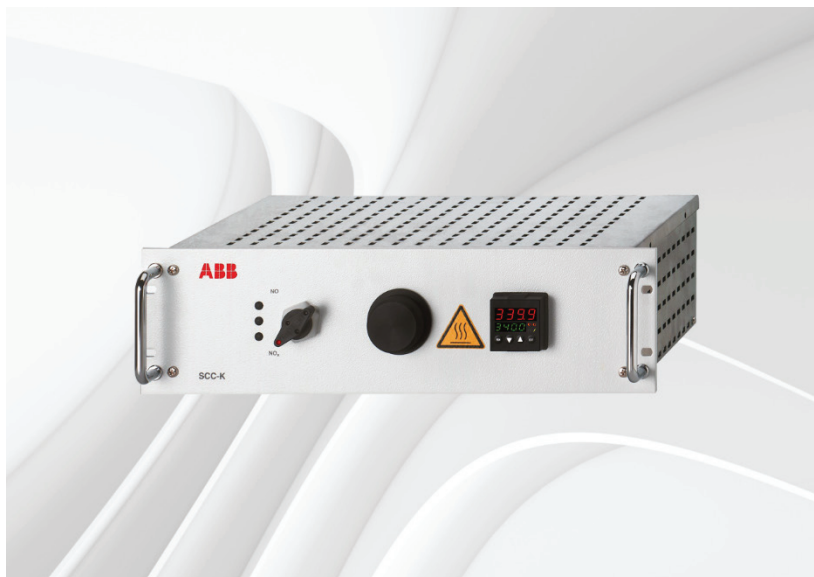

NO<sub>2</sub>/NO converter and  
Thermal converter

**Measurement made easy**



# Contents

<b>Preface</b> .....	<b>4</b>
<b>General safety information</b> .....	<b>5</b>
<b>Safety tips for handling electronic measurement devices</b> .....	<b>6</b>
<b>Converter installation and start-up</b> .....	<b>7</b>
Instructions for selecting a location .....	7
Converter unpacking.....	8
Housing version .....	8
‘Thermal converter’: Installing the quartz glass reaction tube.....	9
Sample gas line connection .....	11
Status and control lead connection .....	12
Power supply wiring connection.....	13
‘NO <sub>2</sub> /NO converter’: Start-up .....	14
‘Thermal converter’: Start-up.....	15
<b>Maintenance</b> .....	<b>16</b>
Preface .....	16
Catalyst service life.....	16
Replacing the catalyst cartridge .....	17
Checking for gas-tightness.....	18
Troubleshooting.....	19
<b>Converter shutdown and packing</b> .....	<b>20</b>
Converter shutdown.....	20
Converter packing .....	20
Disposal .....	21
<b>Annex</b> .....	<b>22</b>
‘NO <sub>2</sub> /NO converter’: Description .....	22
Functional schemes.....	23
Conversion principle.....	24
Converter construction.....	25
Technical data .....	26
Circuit and connection diagram.....	27
‘Thermal converter’: Description.....	28

## Preface

### Content of the operating instruction

This operating instruction contains all the information you will need to safely and efficiently install, start-up, operate and maintain the SCC-K converter.

This operating instruction contains information on all the functional units in the converter. The delivered converter may differ from the version described.

### Further details on the internet

You can find further information on ABB Analytical products and services on the internet: '<http://www.abb.com/analytical>'.

### Symbols and typefaces



Identifies safety information to be heeded during unit operation in order to avoid risks to the operator.



Identifies specific information on operation of the unit as well as on the use of this operating instruction.

**1, 2, 3, ...**

Identifies reference numbers in the figures.

## General safety information

<b>Requirements for safe operation</b>	In order to operate in a safe and efficient manner the instrument should be properly handled and stored, correctly installed and started, properly operated and correctly maintained.
<b>Personnel qualifications</b>	Only persons familiar with the installation, set-up, operation and maintenance of comparable equipment and certified as being capable of such work should work on the instrument.
<b>Special information and precautions</b>	<p>These include</p> <ul style="list-style-type: none"><li>• The content of this operating instruction.</li><li>• The safety information affixed to the instrument.</li><li>• The applicable safety precautions for installing and operating electrical devices</li><li>• Safety precautions for working with gases, acids, condensates, etc.</li></ul>
<b>National regulations</b>	The regulations, standards and guidelines cited in this operating instruction are applicable in the Federal Republic of Germany. The applicable national regulations should be followed when the instrument is used in other countries.
<b>Instrument safety and safe operation</b>	<p>The instrument is designed and tested in accordance with EN 61010 Part 1, 'Safety Provisions for Electrical Measuring, Control, Regulation and Laboratory Instruments' and has been shipped ready for safe operation.</p> <p>To maintain this condition and to assure safe operation, read and follow the safety information identified with the  symbol in this operating instruction. Failure to do so can put persons at risk and can lead to instrument damage as well as damage to other systems and instruments.</p>
<b>Additional information</b>	<p>If the information in this operating instruction does not cover a particular situation, ABB Service is prepared to supply additional information as needed.</p> <p>Please contact your local service representative. For emergencies, please contact ABB Service, Telephone: +49-(0)180-5-222580, Telefax: +49-(0)621-381 931 29031, E-mail: automation.service@de.abb.com</p>

## Safety tips for handling electronic measurement devices

<b>Protective lead connection</b>	The protective lead should be attached to the protective lead connector before any other connection is made.
<b>Risks of loss of protective lead continuity</b>	The instrument can be hazardous if the protective lead is interrupted inside or outside the instrument or if the protective lead is disconnected.
<b>Proper operating voltage</b>	The instrument voltage must be set to match the line voltage before the power supply is activated.
<b>Risks involved in opening the covers</b>	Current-bearing components can be exposed when the covers or parts are removed, even if this can be done without tools. Current can be present at some connection points.
<b>Risks involved in working with an open instrument</b>	The instrument must be disconnected from all power sources before any maintenance work is performed. Work on an instrument that is open and connected to power should only be performed by trained personnel who are familiar with the risks involved.
<b>Charged capacitors</b>	The instrument capacitors can retain their charge even when the instrument is disconnected from all power sources.
<b>Use of proper fuses</b>	Only fuses of the specified type and rated current should be used as replacements. Never use patched fuses. Do not short-circuit the fuseholder contacts.
<b>When safe operation can no longer be assured</b>	<p>If it is apparent that safe operation is no longer possible, the instrument should be taken out of operation and secured against unauthorized use.</p> <p>The possibility of safe operation is excluded:</p> <ul style="list-style-type: none"><li>• If the instrument is visibly damaged</li><li>• If the instrument is no longer operational</li><li>• After prolonged storage under adverse conditions</li><li>• After severe transport stresses</li></ul>

# Converter installation and start-up

## Instructions for selecting a location

<b>Installation location</b>	<p>The converter is intended for indoor use only.</p> <p>The maximum installation altitude is 5,000 m above sea level.</p>
<b>Short gas paths</b>	<p>The converter should be installed as close as possible to the analyzer system in order to avoid the re-oxidation of NO and NO<sub>2</sub> in long sample gas lines.</p>
<b>Adequate air circulation</b>	<p>Provide for adequate natural air circulation around the cooler unit. Avoid heat buildup.</p>
<b>Protection from adverse conditions</b>	<p>Protect the converter from</p> <ul style="list-style-type: none"><li>• Cold</li><li>• Heat sources such as the sun, ovens and vats</li><li>• Large temperature variations</li><li>• Strong air currents</li><li>• Accumulations of dust and dust infiltration</li><li>• Corrosive atmospheres</li><li>• Vibration</li></ul>
<b>Environmental conditions</b>	<p>Ambient temperature range +10 to 50 °C.</p> <p>Average annual relative humidity ≤ 75 %, occasional and slight condensation permitted.</p>

## Converter unpacking



- If there is shipping damage which points to improper handling file a damage claim with the shipper (railway, mail or freight carrier) within seven days.
- Make sure that none of the enclosed accessories are lost during unpacking.
- Keep the shipping box and packaging material for future shipping needs.

### Catalyst cartridge

The catalyst cartridge supplied with the 'NO<sub>2</sub>/NO converter' version is already installed.

### Quartz glass reaction tube

The quartz glass reaction tube supplied with the 'Thermal converter' version must be installed by the user (see page 9).

## Housing version

### Housing version

The converter is designed as a 19-inch unit and is suitable for wall-mounting using a special mounting bracket.

**Figure 1**

**Dimensions in mm (in)**

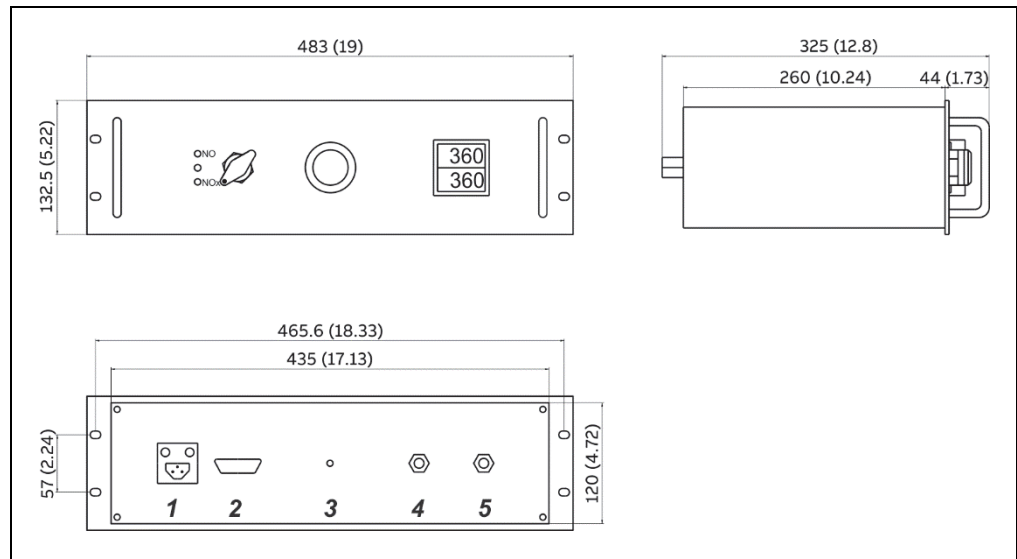

- 1 Power supply input X1
- 2 Status signal output X2 (9-pin Sub-D female connector)
- 3 Heated sample gas inlet 6 mm (only in the 'NO<sub>2</sub>/NO converter' version)
- 4 Sample gas outlet G<sup>1</sup>/<sub>4</sub> female thread
- 5 Sample gas inlet G<sup>1</sup>/<sub>4</sub> female thread



Distance above the converter at least 1 height unit



## ‘Thermal converter’: Installing the quartz glass reaction tube



**ATTENTION!**

**Risk of breakage!** Handle the quartz glass reaction tube with extreme caution, exert no force and avoid touching the glass body!



**ATTENTION!**

**Dangerous voltage!** Disconnect all poles of the converter from the power supply before opening the housing!



**ATTENTION!**

**Hot surface!** Touching it can lead to severe burns! Let the converter cool down before handling! Wear protective gloves!

### Mounting the quartz glass reaction tube

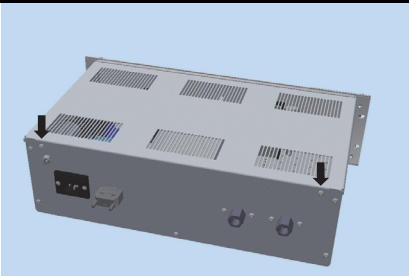
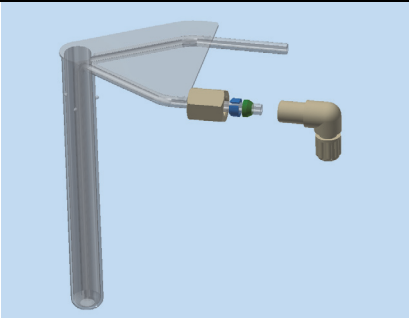
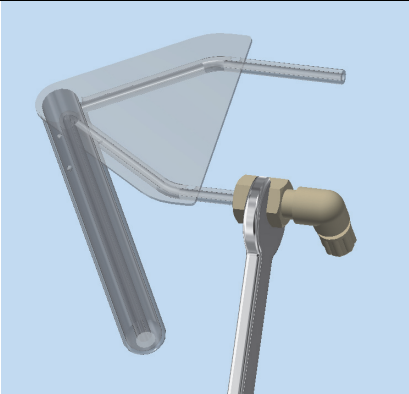
Step	Action	
1	Loosen two screws ↓ and open the housing cover. The quartz tube is located in a transport protection and is fastened in two brackets to the side wall of the housing. The connection fittings and the connecting hoses are located in a separate bag in the housing.	
2	Carefully pull the quartz tube together with the transport protection out of the brackets and remove the transport protection. Carefully hold the quartz tube by the connecting plate between the two connecting tubes or by the glass body.	
3	Place the quartz tube on a flat surface and place the connection fittings on the connection tubes – do not exert any force: 1. Fit the union nut. 2. Fit the pressure ring (ring with opening). 3. Fit the clamping ring (ring with conical seal).	
4	Fit the elbow fitting, fix it in the position shown in the illustration and tighten it with a torque wrench (5 Nm). Alternatively, use a wrench NW17 (approx. 1½ turn).	

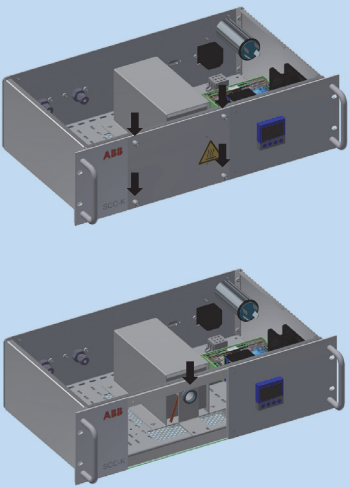
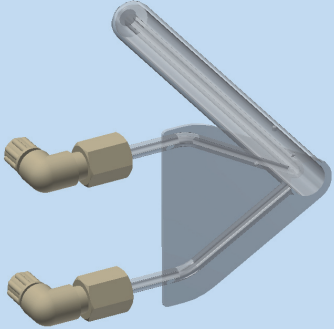
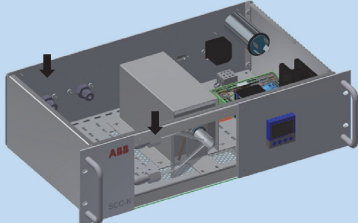
Step	Action	
5	Loosen four screws ↓ and remove the cover in the front panel.	 <p data-bbox="584 470 999 527">The illustration shows the furnace ↓ behind the open front panel.</p>
6	Carefully insert the quartz tube with the mounted connection fittings into the furnace in the orientation shown in the illustration. Carefully hold the quartz tube by the connecting plate between the two connecting tubes.	
7	Connect the connection fittings of the quartz tube to the sample gas connections on the rear wall of the housing: Connect the upper connection pipe ↓ to the sample gas inlet ↓ (see illustration). Connect the lower connection pipe to the sample gas outlet.	
8	Replace the cover on the front panel.	
9	Before installation and commissioning, check the converter for leaks.	

## Sample gas line connection

**Sample gas connections** The gas inlet and outlet hoses/tubes are connected on the rear of the converter. Standard G $\frac{3}{4}$ -inch threaded joints are available for the connection of the gas sample lines.



- Do not confuse hose / tube connections for sample gas inlet and outlet; the connections are labeled accordingly.
- The tightness of the connections can only be guaranteed if the end section of the connection hose / tube is flat (use a hose-cutter).

### Sample gas line connection

Step	Action
1	Loosen the sleeve nut of the clamping-ring threaded joint by turning to the left.  Take care that the nut is removed carefully from the body of the threaded joint to avoid losing the clamping ring which is mounted loose in the nut.
2	Push the sleeve nut over the connection hose / tube.
3	Push the clamping ring onto the connection hose / tube with the thicker bulge pointing to nut.
4	Push the hose / tube onto the supporting nipple in the threaded joint.
5	Tighten the sleeve nut by hand. The hose / tube is now mounted in such a way that it cannot slip and is resistant to pressure.
6	Check for tightness of all sample lines after connection (see page 18).

### Note for CO measurement

For simultaneous measurement of NO<sub>x</sub> and CO (ppm concentrations) the CO measurement must be carried out in a separate gas path (see Fig. 2) due to CO formation in the carbon-molybdenum catalyst.

**Figure 2**

**Location of the NO<sub>2</sub>/NO converter for simultaneous measurement of NO<sub>x</sub> and CO**

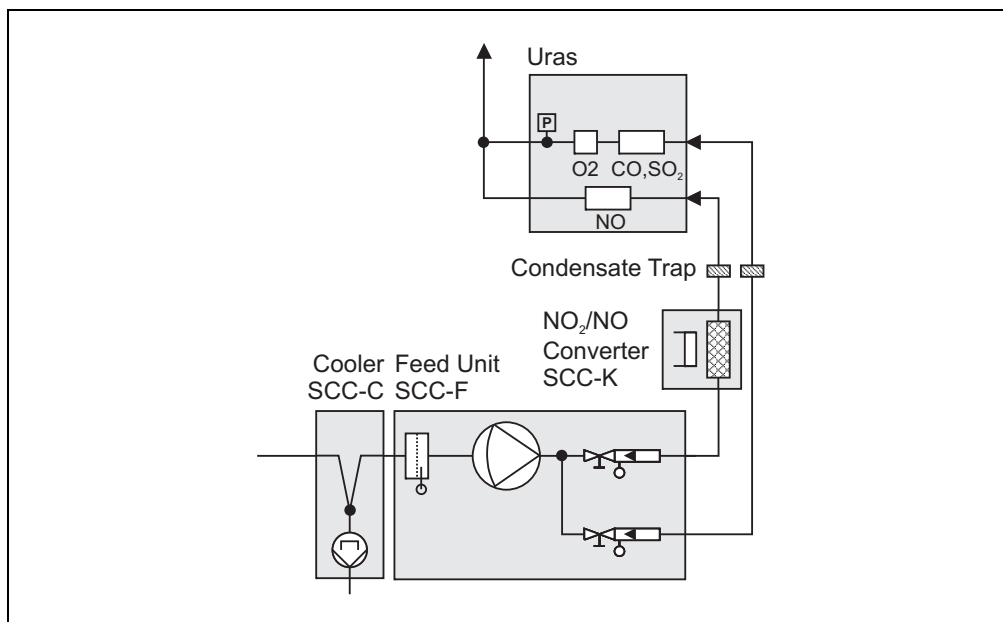

## Status and control lead connection



### CAUTION!

Follow local regulations on installing and connecting electrical wiring.

### Status and control lead connections

The general status alarm for signaling temperatures outside the permitted range and the facility for connecting the solenoid valves externally are provided at the 9-pin sub-D plug on the rear side of the converter housing (see Fig. 3).



Correct functioning of the converter is only guaranteed when the sub-D plug X2 is mounted.

Figure 3

### Pin-out of sub-D plug X2

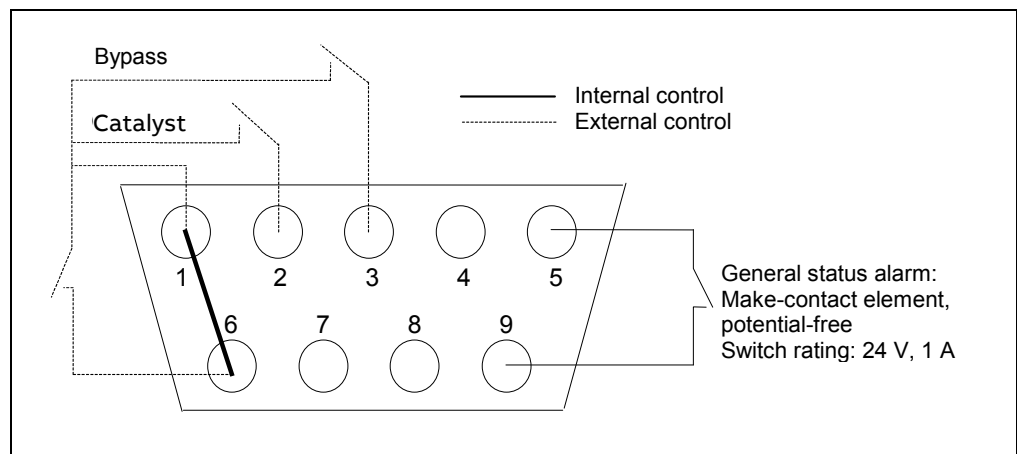

### Temperature alarm

Contacts 5 and 9 are provided in the sub-D plug to ensure sure signaling of temperatures outside the permitted range. This involves a potential-free make-contact element with a switch rating of 24 V, 1 A. The alarm is signaled if temperatures exceed the permitted temperature range by  $\pm 5$  °C.

### Version with two solenoid valves

As an option the converter in the 'NO<sub>2</sub>/NO converter' version has two solenoid valves for switching between sample gas paths. The valves can be controlled either internally or externally by the customer.

### Internal control

If the converter is controlled internally, the bridge between contacts 1 and 6 in the sub-D plug is absolutely necessary.

### External control

External switching is carried out by the customer using potential-free contacts. If the converter is controlled externally, the bridge between contacts 1 and 6 in the sub-D plug must be removed.

With external control the switch on the front plate is out of function. The chosen gas way is indicated by the two LED's.

## Power supply wiring connection



### CAUTION!

Follow all applicable national safety regulations for the preparation and operation of electrical devices as well as the following safety precautions.

**The converter voltage must be set to match the line voltage before the power supply is connected.**

**The protective lead should be attached to the protective lead connector before any other connection is made.**

**The converter can be hazardous if the protective lead is interrupted inside or outside the cooler unit or if the protective lead is disconnected.**



Install a breaker in the power supply line or a switched receptacle near the converter to make sure the converter can be completely separated from the power source. Mark the breaker so that its relationship to the protected device is clear.

### Mains connection

The converter is connected to the mains at the rear of the converter housing via a cold-device plug (X1) with a 2-meter connecting cable.

### Fuses

The main circuit is equipped with fuses corresponding to the nominal current (over current protection).

Both main fuses F1 and F2 (T3.15AH250 V slow-blow fuses) are located below the connector plug X1, on the back panel of the converter housing.

## 'NO<sub>2</sub>/NO converter': Start-up

### Safety measures

Before using the converter for the first time, check that the safety measures specific to the installation and process are complied with!

### Initial start-up

Step	Action
1	Connect converter to the mains; compare the mains voltage with the information on the identification plate before starting up.
2	If necessary, connect general alarm-contact to the measurement control station.
3	Switch sample gas path to 'NO'/'Bypass'.
4	Insert catalyst cartridge into the mounting adapter.
5	Introduce cartridge into the tube furnace and lock into place by turning the adapter handle. Moisten the outer O-rings helps placing the cartridge into the tube furnace.
6	<p>Set the desired catalyst temperature depending on the sample gas flow using the arrow keys on temperature controller:            30 l/h: 320 °C – 60 l/h: 320 °C – 90 l/h: 340 °C – 150 l/h: 360 °C</p> <p>The warm-up time is approx. 30 minutes. The warm-up phase is finished when the LED '1' lights up in the display of the temperature controller.</p> <p> If the setting value is reduced by more than 10 °C, the sensor control will be released and the heating circle switched off. For the reset, wait until the value remains under the new setting value, switch off the mains voltage and switch it on again.</p>
7	When the desired temperature is reached, switch sample gas path over to catalyst operation internally or externally.



When using a new catalyst cartridge for the first time or after longer periods of storage at room temperature, the response time T90 can be substantially longer!

## ‘Thermal converter’: Start-up

### Safety measures

Before using the converter for the first time, check that the safety measures specific to the installation and process are complied with!

### Initial start-up

Step	Action
1	Connect converter to the mains; compare the mains voltage with the information on the identification plate before starting up.
2	If necessary, connect general alarm-contact to the measurement control station.
3	<p>Set the desired catalyst temperature depending on the application and the sample gas flow using the arrow keys on temperature controller (see table below).</p> <p>The warm-up time is approx. 60 minutes. The warm-up phase is finished when the LED ‘1’ lights up in the display of the temperature controller.</p> <p> If the setting value is reduced by more than 10 °C, the sensor control will be released and the heating circle switched off. For the reset, wait until the value remains under the new setting value, switch off the mains voltage and switch it on again.</p>
4	When the desired temperature is reached, the converter is ready for operation.

Application	Measurement	Operating temperature	Sample gas flow rate
Pulp and paper production	TRS measurement, oxidation of sulfur organic and non-organic compounds. Analyzer: Uras26	650 °C	60 l/h
Chlorine plants	Conversion of H <sub>2</sub> to HCl using Cl <sub>2</sub> . Analyzer: Caldos25 (flowing reference gas)	450 °C 500 °C	60 l/h 120 l/h
Chlorinated hydrocarbons CHC, PVC plants	Oxidation of chlorine components. Analyzer: Limas11 IR, measurement of HCl	650 °C	60 l/h

# Maintenance

## Preface

**CAUTION!**

Before carrying out maintenance work, make sure that safety measures specific to the installation and process are complied with!

**CAUTION!**

Dangerous voltage. Disconnect the converter completely from the power source before opening the housing!

**CAUTION!**

Hot surface! Touching it can lead to very severe burns. Wear protective gloves!

**Maintenance periods** The converter does not need special maintenance periods.

## Catalyst service life

**Catalyst service life** The catalyst service life depends essentially on the following factors:

- Sample gas flow rate
- Temperature
- NO<sub>2</sub> concentration in the sample gas
- O<sub>2</sub> concentration in the sample gas

The catalyst service life is > 6 months for 30 l/h, 320 °C, 10 ppm NO<sub>2</sub> and 5 Vol.-% O<sub>2</sub>.

During the stated service life, conversion is over 95 %. If the degree of efficiency falls notably below 95 %, the used catalyst cartridge should be replaced (see page 17).



Adverse conditions in the installation can lead to a substantially shorter catalyst service life!



## Replacing the catalyst cartridge



**CAUTION!**

The catalyst cartridge is hot! Touching the cartridge can lead to very severe burns. Wear protective gloves and safeguard cartridge against unauthorized access!









**CAUTION!**

The catalyst material is irritant and highly flammable! Follow the instructions for use, storage and disposal of the catalyst material given in the enclosed information sheet!

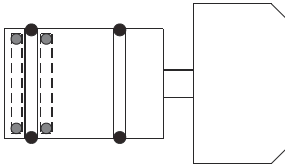

Only original ABB spare parts and consumables may be used!

### Replacing the catalyst cartridge

Step	Action
1	Switch the converter's sample gas path either internally or externally to bypass.  Sample gas can exhaust from the converter during the replacement procedure if the sample gas path is not switched to bypass.
<b>Removing the catalyst cartridge:</b>	
	 <b>CAUTION!</b> The catalyst cartridge is hot!
2	Unlock the adapter of the catalyst cartridge by turning the handle and pull it out of the tube furnace.
3	Pull the catalyst cartridge out of the adapter by twisting gently.
4	Remove the two outside and the two inside O-ring seals from the adapter.
	
<b>Mounting the catalyst cartridge:</b>	
5	Insert new O-ring seals into the outside and inside seal grooves of the adapter.  Do not damage the O-ring seals.
6	Introduce the new catalyst cartridge into the adapter with gentle twisting movements.  In order to obtain the required gas tightness, take care that the cartridge is always inserted into the adapter right up to the stop!
7	Insert the catalyst cartridge into the tube furnace.  Moisten the outer O-rings helps placing the cartridge into the tube furnace. Do not use grease for O-rings because it could affect the efficiency of the catalyst!
8	Lock the adapter of the catalyst cartridge in place by turning the handle.

## Checking for gas-tightness



The converter must be cooled down to room temperature in order to check for gas-tightness!

### Checking for gas-tightness

Step	Action
1	Connect device to mains supply.
2	Set temperature controller to room temperature.
3	'NO <sub>2</sub> /NO converter' version: Switch sample gas path to catalyst operation (lower green LED lights up).
4	Seal sample gas outlet tightly.
5	Connect sample gas outlet with U-tube manometer or similar and upstream stopcock.
6	Release air using the stopcock until the manometer displays a pressure of approximately $p_e = 50$ hPa. <div data-bbox="584 747 646 806" data-label="Image"> </div> Do not exceed the maximum operating pressure: 'NO <sub>2</sub> /NO converter' version: $p_{abs} = 200$ kPa, 'Thermal converter' version: $p_{abs} = 120$ kPa!
7	Close stopcock.
8	A leak is shown by a marked fall in pressure after several minutes.

## Troubleshooting

Problem	Cause	Corrective action
<b>LEDs do not light up</b> <b>Valves do not switch over</b> <b>Temperature controller out of order</b>	No mains power	Check that mains cable fits properly (X1); ok?
	Sub-D plug not inserted in socket X2	Check whether sub-D plug is present and is properly plugged in; ok?
	Fuses F1, F2 defective	Check fuses and replace if necessary (T3.15AH250 V slow-blow fuses).
<b>Converter does not heat up</b>	Heater defective	Measure voltage at terminals X4/2 and 3; ok? Replace heater; not ok?
	Temperature controller defective	Measure voltage at terminal X4/6 and 7; voltage < 8 V DC? Check controller according to operating instruction; voltage > 8 V DC?
	Solid-state relay defective	Replace solid-state relay.
<b>Valves do not switch over</b> <b>LEDs do not light up</b>	No mains supply (see above) Sub-D plug not inserted into socket X2 (see above)	See above
	Internal circuit: No solder link 1-6 in sub-D plug	Check sub-D plug and if necessary solder link
	External circuit: Error in external control	Check external control
<b>Valves do not switch over</b> <b>LEDs light up</b>	Valves defective	Check that valves function
<b>No sample gas flow</b>	Valves defective (see above)	See above
	Gas sample lines blocked or leaking	Check gas sample lines; Check for gas-tightness (see page 18)
<b>No conversion</b>	Cartridge does not heat up (see above)	See above
	No sample gas flow (see above)	See above
<b>Remark</b>	Valves and LEDs are built-in only in the 'NO <sub>2</sub> /NO converter' version.	



## Converter shutdown and packing

### Converter shutdown

<b>Short-term shutdown</b>	No special measures need to be taken when the converter is taken out of operation for a short period.  In order to avoid unnecessary consumption of the catalyst and to ensure that the catalyst is ready for use at short notice, the catalyst temperature should be reduced to approximately 100 °C in the 'stand-by' during brief operational pauses.
<b>Long-term shutdown</b>	When the converter is taken out of operation for more protracted periods, we recommend rinsing the converter with inert gas or air at room temperature.
<b>Ambient temperature</b>	The location at which the converter is mounted must remain frost-free even when the device is switched off.

### Converter packing

#### Packing

Step	Action
	 If the thermal converter is to be packed for shipment, the quartz glass reaction tube must first be removed from the furnace, packed in a suitable transport protection and fastened in the holder in the housing (see also page 9).
1	Whenever possible use the original packaging and padding materials. If the original packaging is not available, cover the converter with bubble paper or corrugated cardboard.
2	Place the converter in an adequately sized box lined with shock-absorbing material (e.g. foam).  The cushioning material's thickness should be adequate for the converter's weight.
3	Mark the box 'Fragile item' and 'Transport upright'.

#### Overseas shipment

Step	Action
1	Add a drying agent (e.g. silica gel) and wrap the converter air-tight in an additional 0.2-mm thick polyethylene sheet.  The amount of drying agent used should be adequate for the package volume and the planned shipping time (at least 3 months).
2	Wrap the box in a layer of kraft paper.

**Ambient temperature** Ambient temperature during storage and transport: -25 to 60 °C

## Disposal

### Notes for disposal

Products that are marked with the adjacent symbol may not be disposed of as unsorted municipal waste (domestic waste). They should be disposed of through separate collection of electric and electronic devices.



This product and its packaging are manufactured from materials that can be recycled by specialist recycling companies.

Bear the following in mind when disposing of this product and its packaging:

- This product is under the open scope of the WEEE Directive 2012/19/EU and relevant national laws.
- The product must be supplied to a specialist recycling company. Do not use municipal waste collection points. These may be used for privately used products only in accordance with WEEE Directive 2012/19/EU.
- If there is no possibility to dispose of the old equipment properly, ABB service can take care of its pick-up and disposal for a fee. To find your local ABB service contact visit [abb.com/contacts](http://abb.com/contacts) or call +49 180 5 222 580.

## Annex

### 'NO<sub>2</sub>/NO converter': Description

<b>Legal requirements</b>	In combustion processes – such as, for example, in large furnaces – in which the nitrogen dioxide content amount to more than 5 % of the nitrogen oxide emission, continuous measurement of total nitrogen oxide NO <sub>x</sub> consisting of nitrogen monoxide NO and nitrogen dioxide NO <sub>2</sub> is prescribed by law in Germany.
<b>Functional principle</b>	The SCC-K NO <sub>2</sub> /NO converter converts the NO <sub>2</sub> content of the sample gas by catalysis into NO (see also section 'Conversion principle', page 24). To do this the sample gas is conducted through a special stainless steel cartridge with a catalyst-filling based on carbon-molybdenum. This conversion makes it possible to measure nitrogen oxides indirectly using all commercially available NO-selective measurement instruments.
<b>Construction</b>	The converter is designed as compact, user-friendly and easy to service 19-inch plug-in unit for mounting in 19-inch cabinet systems or with a mounting bracket for wall-mounting (see also section 'Converter construction', page 25).
<b>Catalyst cartridge</b>	The catalyst is filled and formatted at the works and is ready for use immediately. The ability to select the appropriate catalyst filling and the possibility of adjusting the cartridge temperature optimally to the catalytic reaction by way of an electronic temperature controller means that the converter can be used in a wide range of applications.

## Functional schemes

**Figure 4**  
Standard version with 4-way ball valve

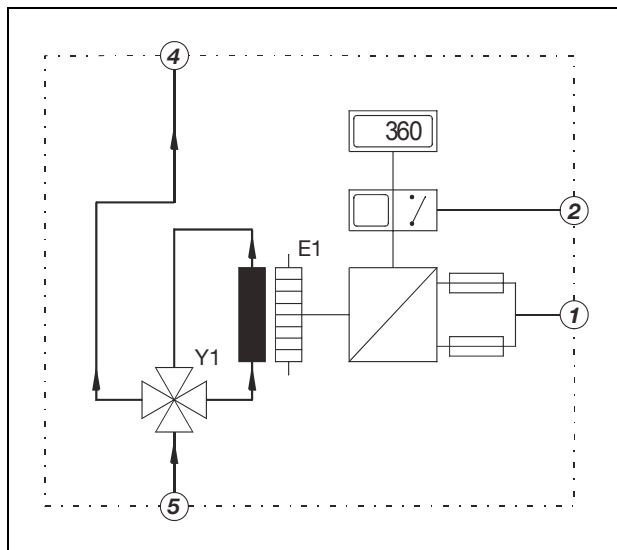

- 1 Power supply
- 2 Status signal
- 4 Sample gas outlet
- 5 Sample gas inlet
- E1 Tube furnace
- Y1 4-way ball valve

Catalog numbers:  
23093-4-0801974 (240 VAC)  
23093-4-0801977 (120 VAC)

**Figure 5**  
Option with 2 solenoid valves

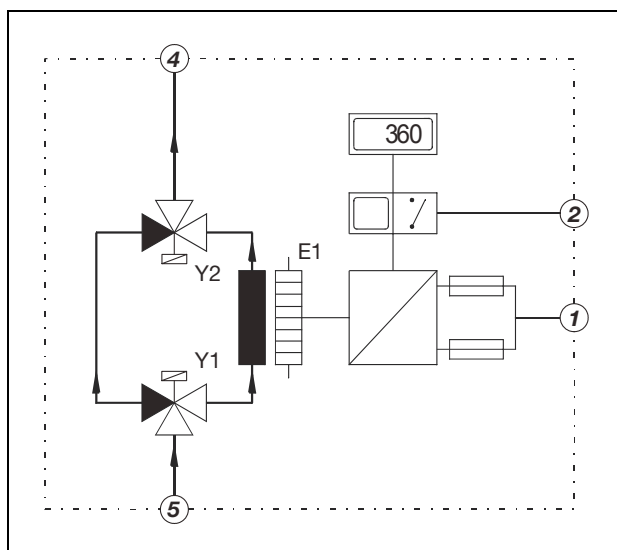

- 1 Power supply
- 2 Status signal
- 4 Sample gas outlet
- 5 Sample gas inlet
- E1 Tube furnace
- Y1 3/2-way solenoid valve
- Y2 3/2-way solenoid valve

Catalog numbers:  
23093-4-0801975 (240 VAC)  
23093-4-0801978 (120 VAC)

**Figure 6**  
Option with heated sample gas inlet

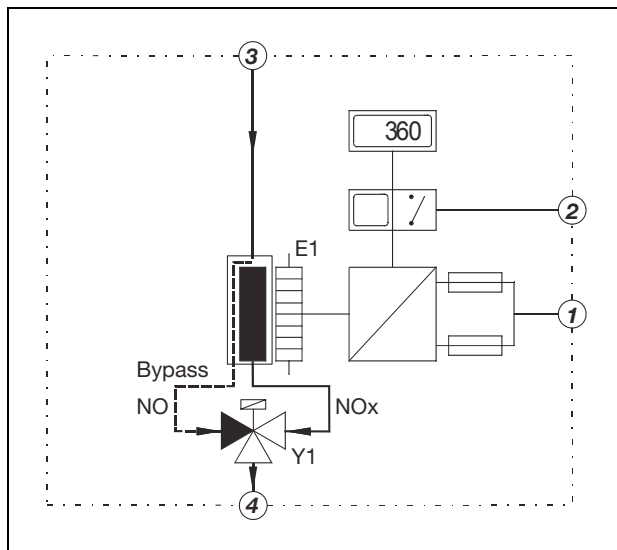

- 1 Power supply
- 2 Status signal
- 3 Heated sample gas inlet
- 4 Sample gas outlet
- E1 Tube furnace
- Y1 3/2-way solenoid valve

Catalog numbers:  
23093-4-0801976 (240 VAC)  
23093-4-0801979 (120 VAC)

## Conversion principle

<b>Reaction equation</b>	<p>The conversion of nitrogen dioxide NO<sub>2</sub> into nitrogen monoxide NO occurs according to the following gross reaction equation:</p> $2 \text{NO}_2 \leftrightarrow 2 \text{NO} + \text{O}_2$
<b>Reaction equilibrium</b>	<p>The reaction equilibrium is shifted entirely onto the side of the original material NO<sub>2</sub>. A shift of the equilibrium towards the products and the resultant high product yield can only be achieved subject to a high expenditure of energy, i.e. temperature (100% conversion at temperatures over 600 °C).</p>
<b>Using a catalyst</b>	<p>By using a catalyst the activation energy of the above reaction is reduced considerably so that conversion rates of 99% are possible at temperatures below 400 °C.</p>
<b>Catalyst</b>	<p>A carbon-molybdenum mixture is used as catalyst. The carbon supporting material guarantees optimal contact between the gas to be converted and the surface of the catalyst combined with a simultaneously low flow resistance.</p>
<b>Catalyst temperatures</b>	<p>The catalyst temperature can be adjusted continuously using the temperature controller on the front of the converter.</p> <p>The recommended settings for catalyst temperatures depending on the gas flow-rate for a conversion rate above 95% are:</p> <p>30 l/h: 320 °C – 60 l/h: 320 °C – 90 l/h: 340 °C – 150 l/h: 360 °C</p>
<b>Gas conditioning</b>	<p>For reasons associated with the filter effect of the catalyst filling an appropriate gas conditioning system is to be mounted upstream of the converter in order to separate out suspended particles and to dry the sample gas!</p>
<b>Cross-sensitivities</b>	<p>Ammonia (NH<sub>3</sub>) in the sample gas converts a part of the NO<sub>2</sub> into dinitrogen oxide N<sub>2</sub>O and elementary N<sub>2</sub>. Depending on the ammonia concentration, this can cause a substantial reduction in the conversion rate.</p>



## Converter construction

**Figure 7**

**Views from front and back**

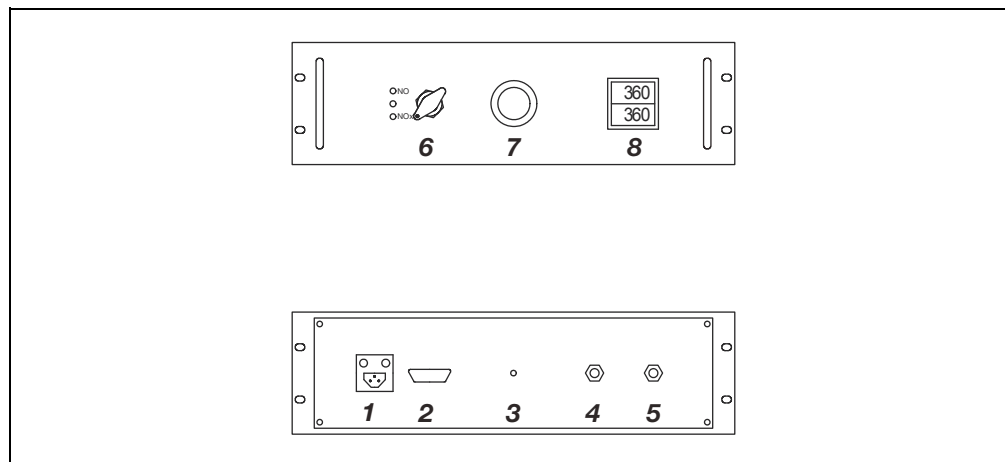

### Mounting

The SCC-K converter is designed as compact, user-friendly and easy to service 19-inch plug-in unit for mounting in 19-inch cabinet systems. When fitted with a mounting bracket with a vertical swivel-holder, the converters can also be wall-mounted.

### Supply-line connections

The supply-line connections are located on the rear side of the converter's housing (see Fig. 7):

- 1 Power supply input X1,
- 2 Status signal output X2 (9-pin Sub-D female connector),
- 3 Heated sample gas inlet 6 mm (only in the 'NO<sub>2</sub>/NO converter' version)
- 4 Sample gas outlet G<sup>1</sup>/<sub>4</sub> female thread,
- 5 Sample gas inlet G<sup>1</sup>/<sub>4</sub> female thread.

### Operating elements

The operating elements are located on the front panel of the converter's housing (see Fig. 7):

- 6 Selector switch for bypassing the catalyst cartridge,
- 7 Mounting adapter with handle for the catalyst cartridge,
- 8 Temperature controller with digital temperature display.

### Catalyst cartridge

The catalyst cartridge is mounted in a heat-insulated tube furnace. The special mounting adapter with handle allows the hot catalyst cartridge to be released and removed without tools being needed.

### Temperature controller

The converter temperature is electronically controlled and can be set continuously at the temperature controller on the converter's front panel in a range between 50 °C and 700 °C depending on the catalytic reaction.

### Status signals

One alarm for excessively high and low temperatures is provided as a status contact output at the 9-pin sub-D-plug on the rear side of the converter.

**Solenoid valves**

In the respective version, two internally or externally controlled PVDF 3/2 way bypass solenoid valves (see Fig. 5) allow the catalyst to be bypassed, for example for test purposes. The desired sample gas path is selected internally via the switch on the converter's front panel or can be switched externally via the 9-pin sub-D plug located on the rear of the converter. Two green LEDs confirm the sample gas path selected:

internally:

Switch position 'up': upper LED lights up green, sample gas path via bypass,  
 Switch position 'down': lower LED lights up green, sample gas path via catalyst.

**Ventilation**

The built-in ventilator in conjunction with the ventilation slits in the converter's housing provides the necessary ventilation.

**Technical data****Operating data**

Sample gas flow rate	max. 150 l/h
Working temperature	depending on sample gas flow rate: 30 l/h: 320 °C 60 l/h: 320 °C 90 l/h: 340 °C 150 l/h: 360 °C
Effectivity	≥ 95 % with new catalyst
Sample gas pressure	$p_{abs} \leq 200 \text{ kPa}$ (2 bar)
Pressure drop	≤ 2 kPa (20 mbar) at 90 l/h
Warm-up time	approx. 30 min
90% time	$T_{90} \leq 10 \text{ s}$ at 60 l/h

**Power supply**

Input voltage	240 VAC, -15/+10 %, 48 to 62 Hz or 120 VAC, -10/+10 %, 48 to 62 Hz
Power consumption	240 VAC: 575 VA; 120 VAC: max. 560 VA
Pay attention to a secure protective lead connection.	

**Electrical safety**

Testing	to EN 61010-1:2010
Protective class	I
Overvoltage category / degree of contamination	II / 2
Protective separation	Electrical isolation of the 120/240 VAC power supply from the other current circuits by means of reinforced or double insulation. Functional extra-low voltage (PELV) on the low voltage side.

**Further data**

Sound power level	< 85 dBA
Weight	approx. 8 to 9 kg

**Ambient conditions**

Ambient temperature	during operation: +10 to 50 °C, during storage and transport: -25 to 65 °C
Relative air humidity	≤ 75 % annual mean, occasional and slight condensation permitted

# Circuit and connection diagram

Figure 8  
Circuit and connection diagram

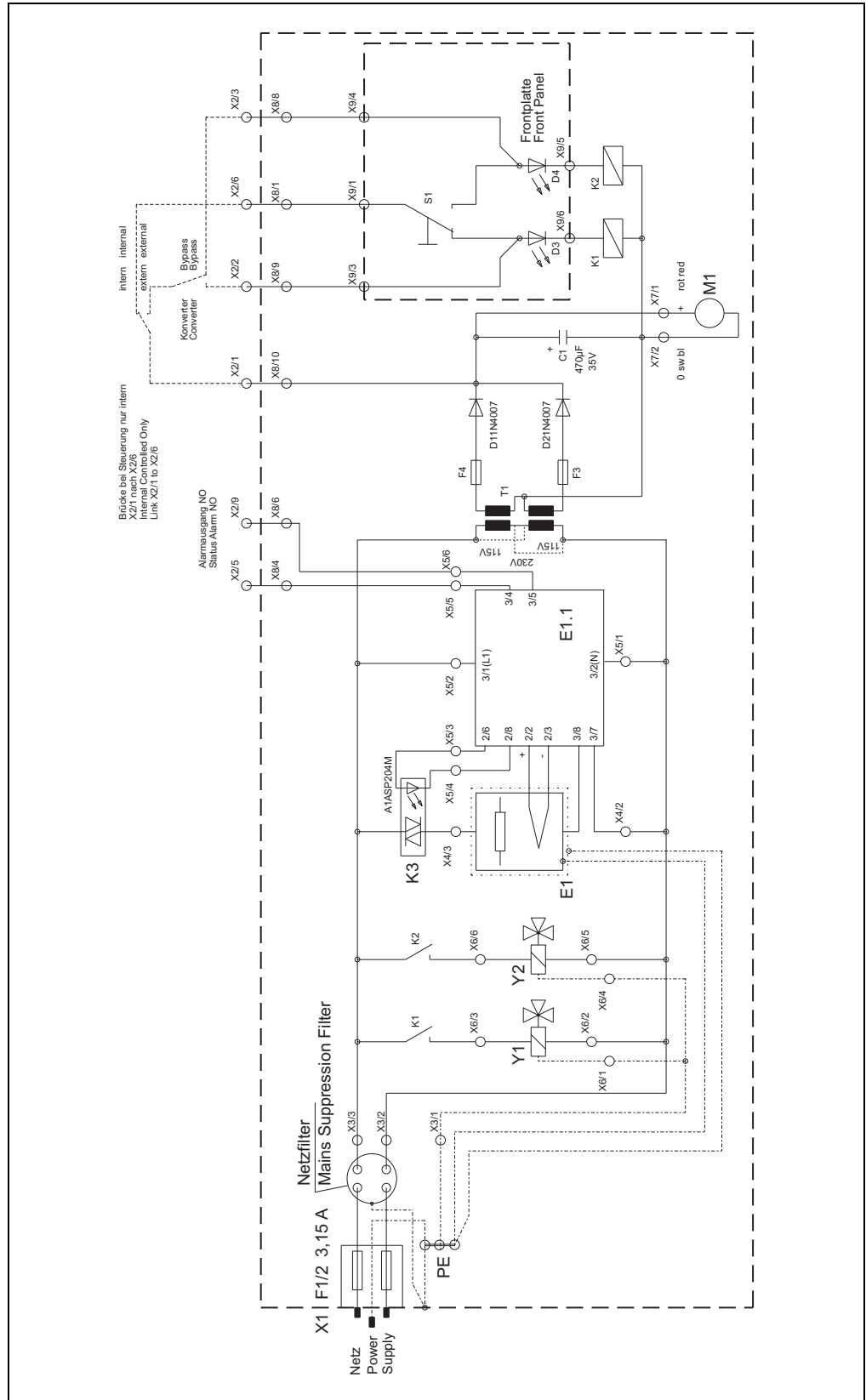

## 'Thermal converter': Description

### Application

The thermal converter is used to convert non-measurable gas components into a compound which can be measured by a gas analyzer. This is necessary e.g. with certain carbon, sulfur and chlorine compounds.

A further application is removing interfering components from the sample gas without the other gas components being affected.

The conversion is based on a thermal reaction and is performed in a heated quartz-glass reaction tube.

**Figure 9**  
**Functional scheme**

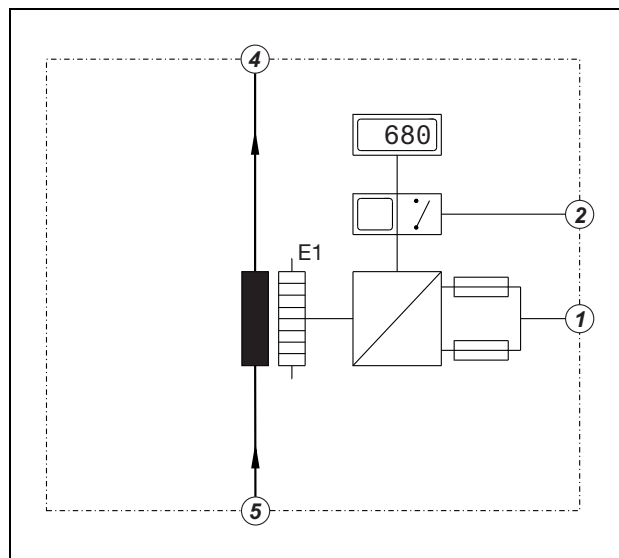

- 1 Power supply
- 2 Status signal
- 4 Sample gas outlet
- 5 Sample gas inlet
- E1 Heated reaction tube

Catalog numbers:  
23093-4-3KXG801000U0100  
(240 VAC)  
23093-4-3KXG801001U0100  
(120 VAC)

### Operating data

Sample gas flow rate	normally 60 l/h, max. 120 l/h
Sample gas temperature	Inlet temperature max. 80 °C (dew point dry)
Sample gas pressure	$p_{abs} \leq 120 \text{ kPa}$ (1.2 bar)
Pressure drop	$\leq 0,5 \text{ kPa}$ (5 mbar)
Effectivity	$\geq 99 \%$
Warm-up time	approx. 60 min
90% time	$T_{90} \leq 10 \text{ sec. at } 60 \text{ l/h}$



—  
**ABB Automation GmbH**  
**Measurement & Analytics**

Stierstädter Str. 5  
60488 Frankfurt am Main  
Germany  
E-mail: [cga@de.abb.com](mailto:cga@de.abb.com)

**[abb.com/analytical](http://abb.com/analytical)**

—  
We reserve the right to make technical changes or modify the contents of this document without prior notice. With regard to purchase orders, the agreed particulars shall prevail. ABB does not accept any responsibility whatsoever for potential errors or possible lack of information in this document.

We reserve all rights in this document and in the subject matter and illustrations contained therein. Any reproduction, disclosure to third parties or utilization of its contents – in whole or in parts – is forbidden without prior written consent of ABB.