

# WaterMaster FET100

## Electromagnetic flowmeter Transmitter



The perfect fit for all water industry applications

**Measurement made easy**

WaterMaster FET100  
electromagnetic  
flowmeter  
transmitter

### Introduction

WaterMaster™ is a range of high performance electromagnetic flowmeters for the measurement of electrically-conductive fluids and systems are normally supplied factory-configured and calibrated.

This User Guide provides installation, connection, security, start-up and basic setup details. For programming and configuration information refer to the Programming Guide – [IM/WMP](#).

For a comprehensive overview of publications available for the WaterMaster transmitter (including links) refer to the inside cover.

### For more information

Further publications are available for free download from [www.abb.com/flow](http://www.abb.com/flow) or by scanning this code:



#### Search for or click on

Data Sheet  
WaterMaster  
Electromagnetic flowmeter

[DS/WM-EN](#)

Programming Guide  
WaterMaster  
Electromagnetic flowmeter

[IM/WMP](#)

## Related documents

### WaterMaster flowmeter (FET100)

---

Programming Guide  
WaterMaster  
Electromagnetic flowmeter

[IM/WMP](#)

---

User Guide  
WaterMaster FET100  
Electromagnetic flowmeter/transmitter | Hazardous areas ATEX/IECEx areas 2, 21 and 22

[OI/FET100/ATEX-EN](#)

---

User Guide Supplement  
WaterMaster FEX100-MB  
Electromagnetic flowmeter | MODBUS RS485 Physical Layer

[COI/FEX100/MOD-EN](#)

---

MODBUS Tables Supplement  
WaterMaster  
Electromagnetic flowmeter

[COI/FEX100/MOD/TBL-EN](#)

---

User Guide Supplement  
WaterMaster  
Electromagnetic flowmeter | PROFIBUS RS485 Physical Layer (FEX100-DP)

[IM/WMPBS-EN](#)

---

User Guide Supplement  
WaterMaster  
Electromagnetic flowmeter | PROFIBUS FEX100-DP parameter tables

---

[IM/WMPBST-EN](#)

<b>1</b>	<b>Safety .....</b>	<b>2</b>
1.1	Electrical Safety .....	2
1.2	Symbols .....	2
1.3	Product Recycling Information ((European customers only) .....	2
1.4	Health & Safety .....	3
1.5	Information on ROHS Directive 2011/65/EU (RoHS II) .....	3
<b>2</b>	<b>Mechanical Installation .....</b>	<b>4</b>
2.1	Installation Conditions .....	4
2.2	Dimensions .....	6
<b>3</b>	<b>Electrical Installation .....</b>	<b>8</b>
3.1	Remote Transmitter / Sensor Arrangement .....	8
3.2	Transmitter Terminal Connections .....	10
3.3	Cable Preparation (Remote Systems Only) .....	11
3.4	Transmitter / Sensor Cable Connections .....	12
3.4.1	Sensor Cable Terminal Connections and Recommended Cable Lengths .....	12
3.5	Output Connections .....	13
3.5.1	Frequency Outputs .....	13
3.5.2	Alarm Outputs .....	15
3.5.3	Contact Input .....	16
3.5.4	PLC Interface .....	17
3.5.5	Current Output (4 to 20 mA) – HART (FEX100) Variant .....	18
3.5.6	RS485 Communications – PROFIBUS (FEX100-DP) and MODBUS (FEX100-MB) Variants .....	18
3.5.7	Test Point Access .....	18
3.6	Power Supply Connections .....	20
3.6.1	AC Power Supply .....	20
3.6.2	DC (and Low Voltage AC) Power Supply .....	21
3.6.3	Configuration DIP Switches .....	22
3.7	Refitting the Cartridge and Cover .....	22
<b>4</b>	<b>Start-up and Operation .....</b>	<b>24</b>
4.1	Navigating the Menus and Parameters .....	24
4.2	Start-up Screens .....	25
4.3	Security Levels and Password Access .....	27
4.3.1	Default Passwords .....	28
4.3.2	Entering Passwords .....	28
4.4	Easy Setup .....	29
<b>5</b>	<b>Specification .....</b>	<b>31</b>

# 1 Safety

Information in this manual is intended only to assist our customers in the efficient operation of our equipment. Use of this manual for any other purpose is specifically prohibited and its contents are not to be reproduced in full or part without prior approval of the Technical Publications Department.





## 1.1 Electrical Safety





This equipment follows, obeys the requirements of CEI/IEC 61010-1:2001-2 'Safety Requirements for Electrical Equipment for Measurement, Control and Laboratory Use' and follows, obeys NIST and OSHA.

If the equipment is used in a manner NOT specified by the Company, the protection provided by the equipment may be impaired.

## 1.2 Symbols

One or more of the following symbols may appear on the equipment labeling:

	<b>Warning</b> – Refer to the manual for instructions
	<b>Caution</b> – Risk of electric shock
	Protective earth (ground) terminal
	Earth (ground) terminal

	Direct current supply only
	Alternating current supply only
	Both direct and alternating current supply
	The equipment is protected through double insulation

## 1.3 Product Recycling Information ((European customers only)

	<p>ABB is committed to ensuring that the risk of any environmental damage or pollution caused by any of its products is minimized as far as possible. The European Waste Electrical and Electronic Equipment (WEEE) Directive that initially came into force on August 13 2005 aims to reduce the waste arising from electrical and electronic equipment; and improve the environmental performance of all those involved in the life cycle of electrical and electronic equipment.</p> <p>In conformity with European local and national regulations, electrical equipment marked with the above symbol may not be disposed of in European public disposal systems after 12 August 2005.</p>
--	---

**Note.** For return for recycling, please contact the equipment manufacturer or supplier for instructions on how to return end-of-life equipment for proper disposal.

## 1.4 Health & Safety

### Health and Safety

To ensure that our products are safe and without risk to health, the following points must be noted:

- The safety requirements of this equipment, any associated equipment and the local environment must be taken into consideration during installation.
- Install and use this equipment and any associated equipment in accordance with the relevant national and local standards.
- The relevant sections of these instructions must be read carefully before proceeding.
- Warning labels on containers and packages must be observed.
- Installation, operation, maintenance and servicing must only be carried out by suitably trained personnel and in accordance with the information given.
- Normal safety precautions must be taken to avoid the possibility of an accident occurring when operating in conditions of high pressure and / or temperature.
- Chemicals must be stored away from heat, protected from temperature extremes and powders kept dry. Normal safe handling procedures must be used.
- When disposing of chemicals ensure that no two chemicals are mixed.
- Product liability – advice and assistance provided without charge is given in good faith but without liability.

Safety advice concerning the use of the equipment described in this manual or any relevant hazard data sheets (where applicable) may be obtained from the Company address on the back cover, together with servicing and spares information.

### Warning.

- System configuration must be carried out only by users or personnel with approved access rights (user privileges).
- Read all relevant sections of this guide before configuring the system or modifying system parameters.
- Install and use associated equipment in accordance with the relevant national and local standards.

## 1.5 Information on ROHS Directive 2011/65/EU (RoHS II)



ABB, Industrial Automation, Measurement & Analytics, UK, fully supports the objectives of the ROHS II directive. All in-scope products placed on the market by IAMA UK on and following the 22nd of July 2017 and without any specific exemption, will be compliant to the ROHS II directive, 2011/65/EU.

## 2 Mechanical Installation

### 2.1 Installation Conditions

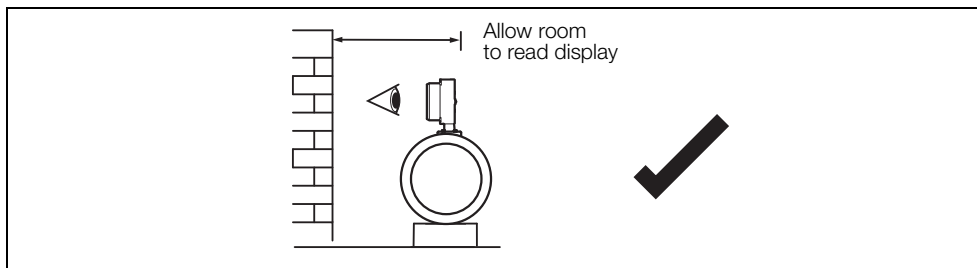

Fig. 2.1 Siting

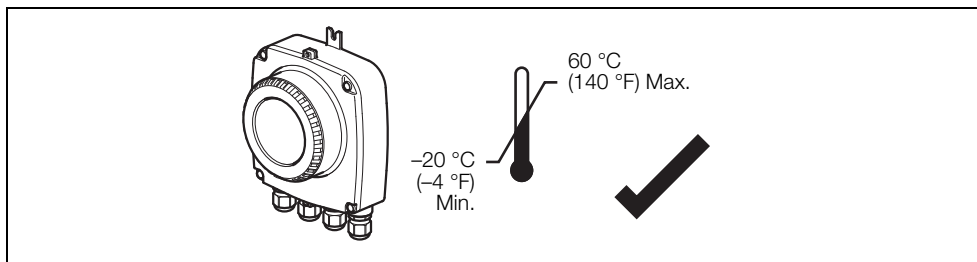

Fig. 2.2 Within Temperature Limits

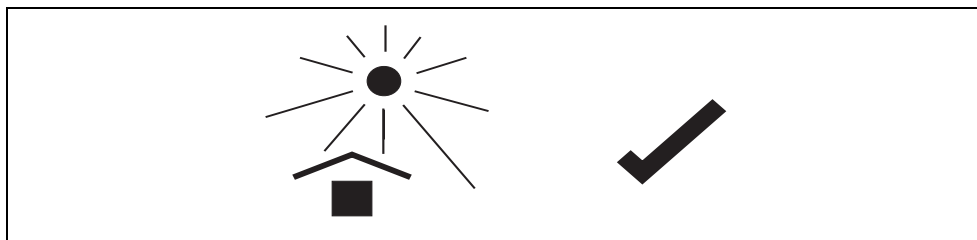

Fig. 2.3 Shade

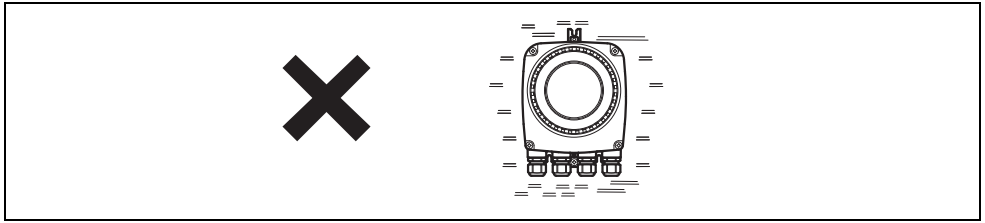

Fig. 2.4 Vibration

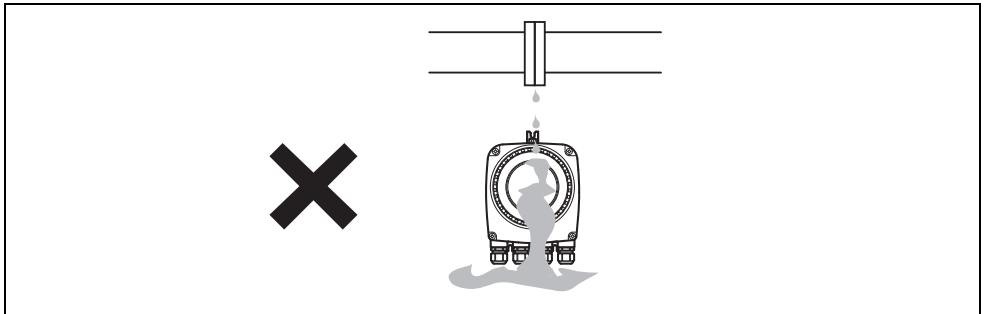

Fig. 2.5 Spillage

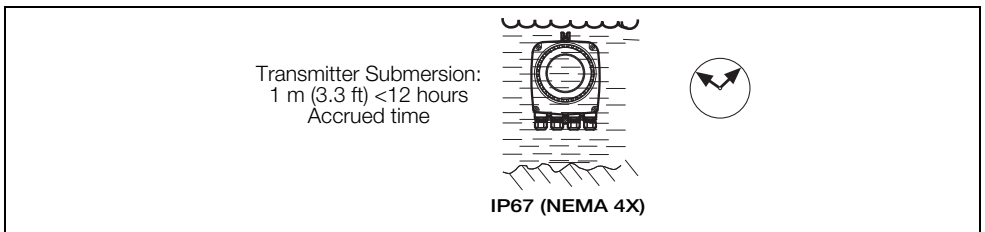

Fig. 2.6 Within Environmental Rating

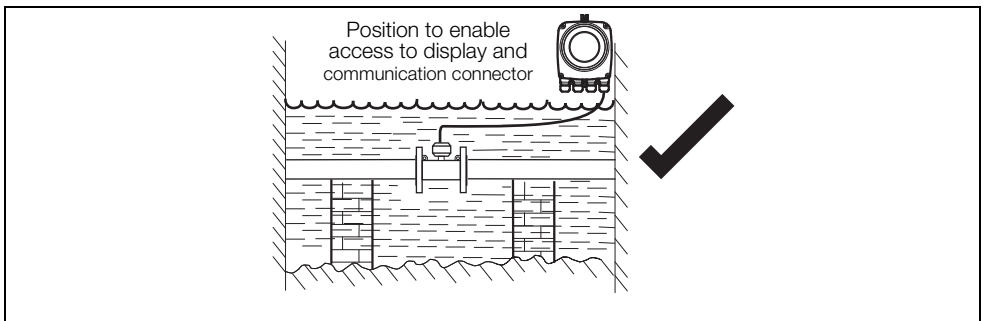

Fig. 2.7 Access to Transmitter

## 2.2 Dimensions

Dimensions in mm (in).

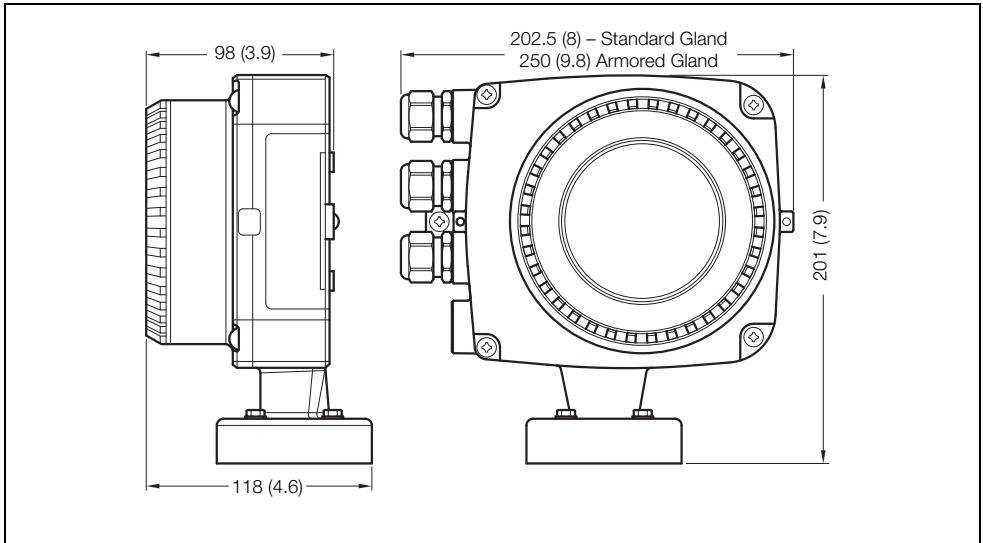

Fig. 2.8 Integral Transmitter Dimensions (Standard Gland Shown)



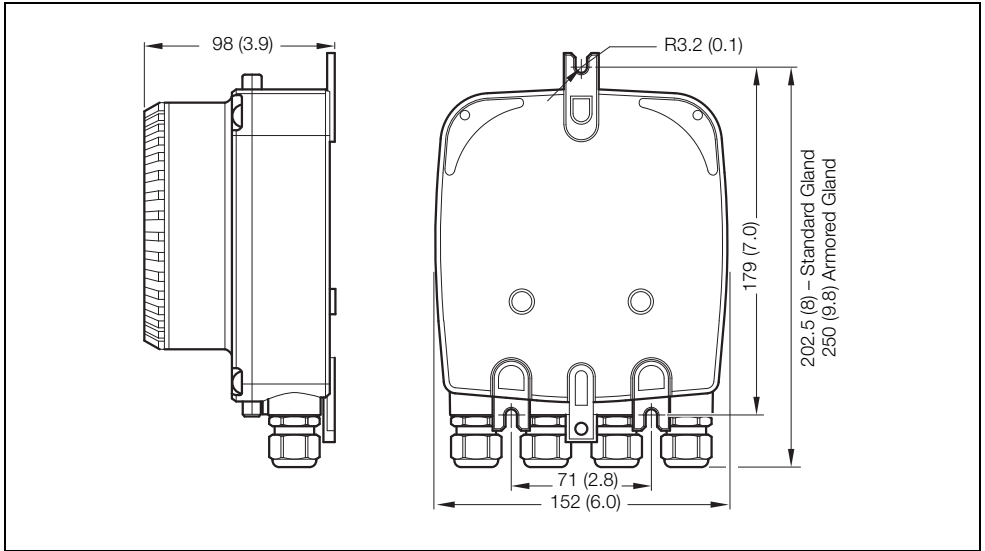

Fig. 2.9 Remote Transmitter Dimensions (Standard Gland Shown)

**Note.** Fix remote transmitter to a secure surface using 3 x M5 screws (not supplied).

## 3 Electrical Installation

### 3.1 Remote Transmitter / Sensor Arrangement

**Note.** For bonding connections use  $\geq 4\text{mm}^2$  (< 10AWG) cable.

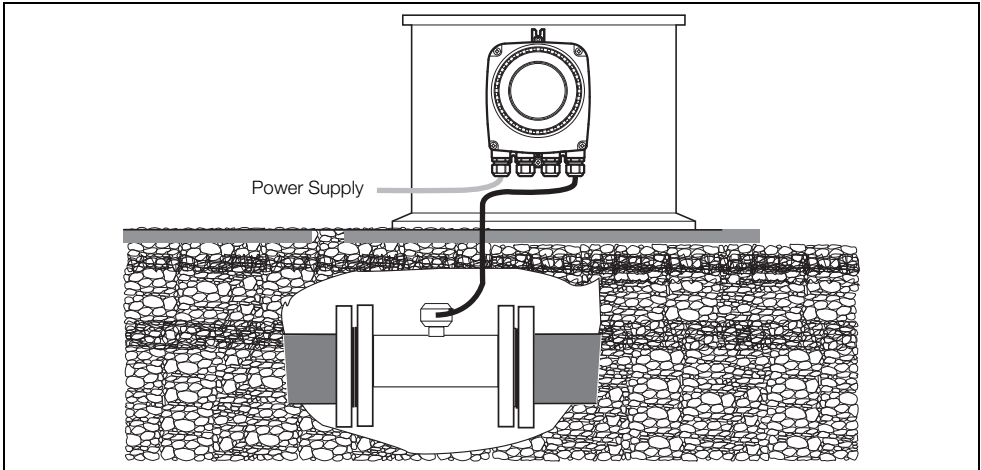
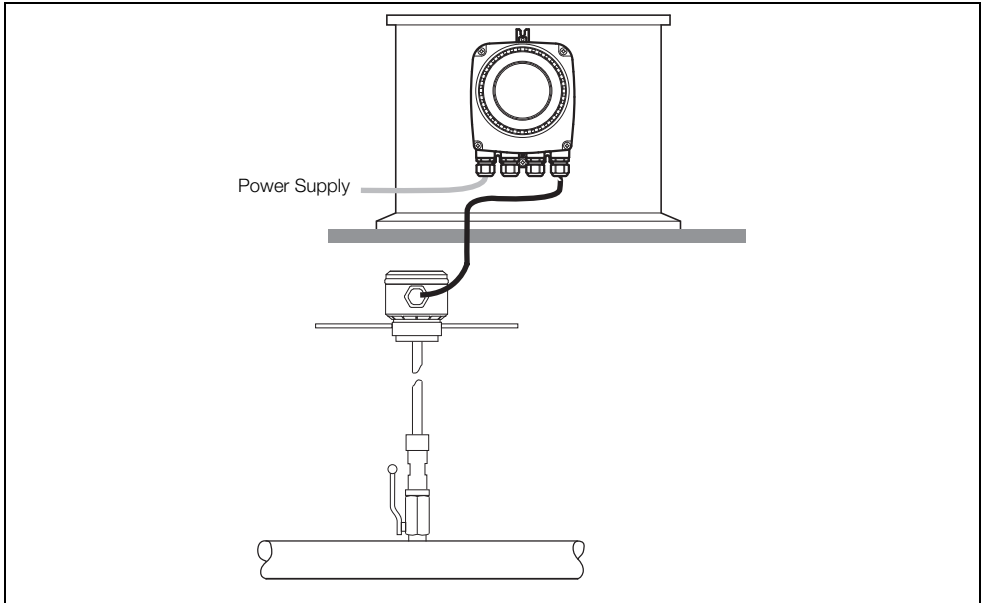

Fig. 3.1 Remote Transmitter in Roadside Cabinet – Flanged Sensor



*Fig. 3.2 Remote Transmitter in Roadside Cabinet – Probe Sensor*

## 3.2 Transmitter Terminal Connections

### Warning.

- Isolate the transmitter from power supplies before removing the cover.
- For flowmeters ordered with the Measuring Instruments Directive (MID) option / variant it is a legal requirement that, at the end of installation, the flowmeter is sealed to prevent unauthorized changes – see Section 3.6.3, page 22 and 3.7, page 22.

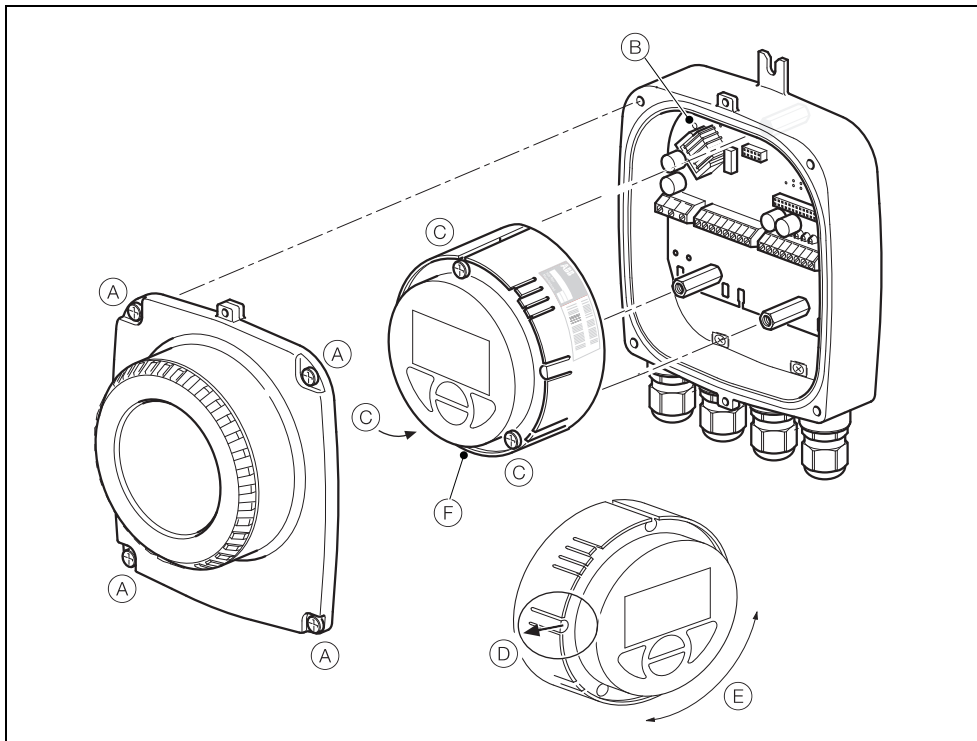

Fig. 3.3 Accessing the Transmitter Terminals

Referring to Fig. 3.3:

1. Slacken (but do not remove) the four transmitter cover screws (A).
2. Remove the transmitter cover.
3. Check that the power indicator LED (B) on the backplane is **not** lit.

**Warning.** If the power indicator LED (B) is lit, the transmitter is still powered up. Before continuing, isolate the transmitter power supply.

4. If screws (C) are not visible, access them by gently pulling the rotation lock (D) back and rotating the cartridge (E) until the cartridge screw access holes align with the cartridge screw heads.

- Slacken the three cartridge screws and lift the cartridge (F) away from the housing.

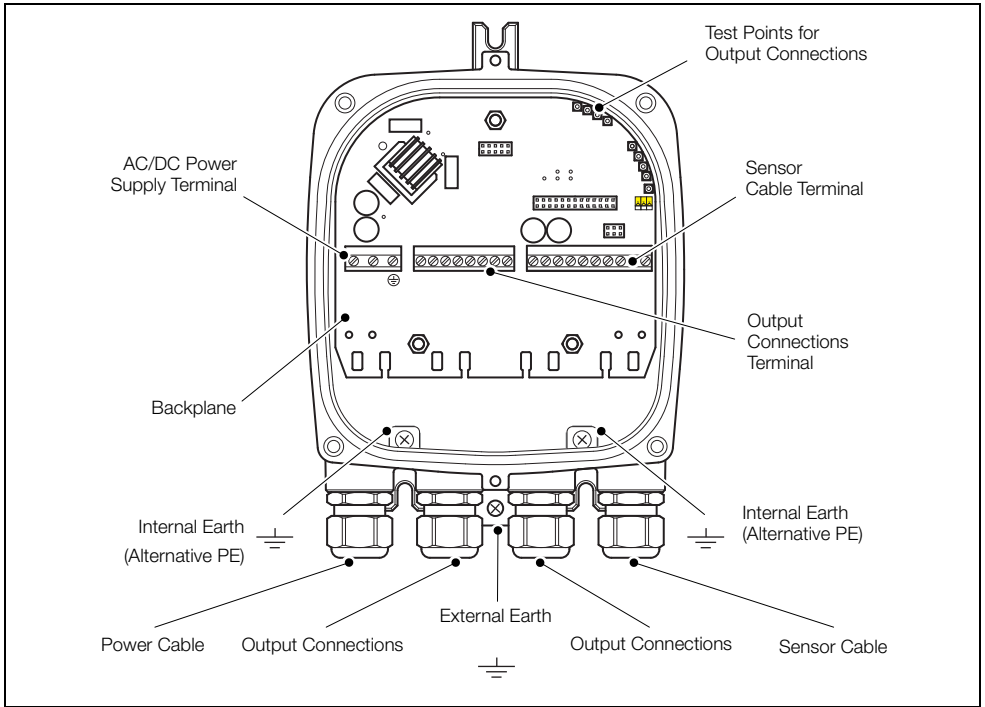

Fig. 3.4 Cable Gland / Conduit Entry (Remote Transmitter Shown)

### 3.3 Cable Preparation (Remote Systems Only)

To prepare the cable for connection at the transmitter and sensor terminal blocks:

- Remove the outer cable insulation and Mylar® wrap.
- Ensure the drain wire is sleeved.
- Cut the cable connection wires to the lengths shown in Fig 3.5, page 12.

### 3.4 Transmitter / Sensor Cable Connections

**Caution.**

- Make connections only as shown.
- Twist the screen wire of D1 / TFE + D2 with the outer screen drain wire and sleeve them.
- For standard (non-cathodically protected) systems, connect the drain wire to the earth screw.
- For cathodically protected systems, connect the drain wire to terminal SCR, ensuring no braid or wires touch the exposed copper areas within the transmitter sensor cable wiring area.
- If an earth screw is not available at the transmitter enclosure, connect the drain wire to terminal SCR.
- Ensure the seal and mating surfaces are clean to maintain environmental rating.
- Conduit connections must provide cable entry sealing.
- Ensure cable glands are tightened after wiring. Do not overtighten the plastic cable glands to avoid destroying their sealing properties. Initially, tighten finger-tight, then a further 1/2 to 3/4 turn using a suitable spanner or wrench.
- Fit blanking plugs where required.

#### 3.4.1 Sensor Cable Terminal Connections and Recommended Cable Lengths

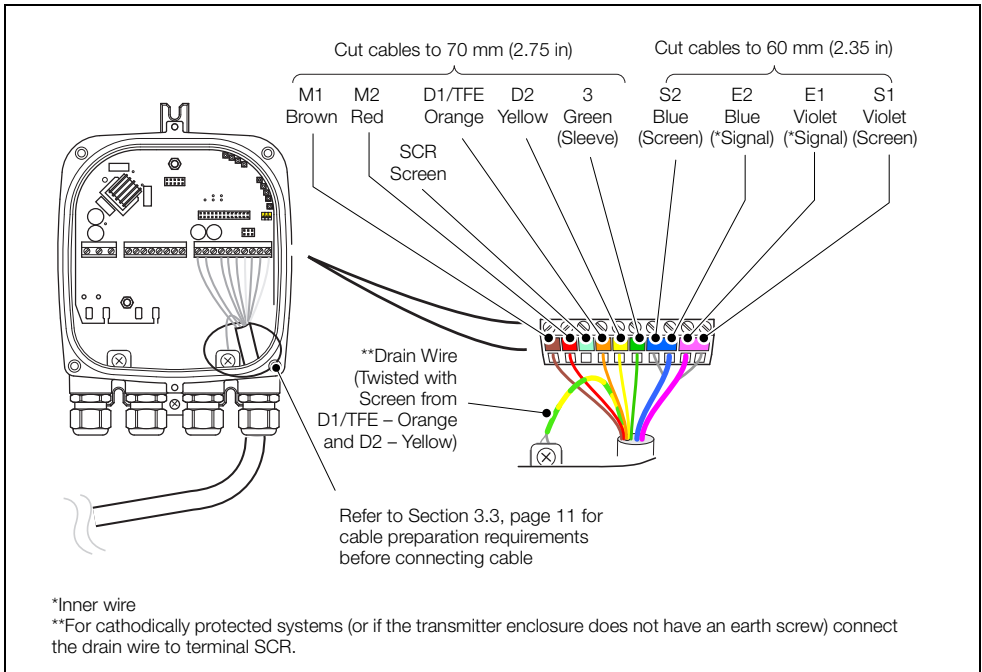

Fig. 3.5 Sensor Cable Connections at Transmitter Terminal Block – Standard System

### 3.5 Output Connections

**Caution.**

- Inductive loads must be suppressed or clamped to limit voltage swings.
- Operation of outputs is programmable.
- External isolators are not normally required as the pulse and alarm circuit is electrically separated from all other WaterMaster connections.

#### 3.5.1 Frequency Outputs

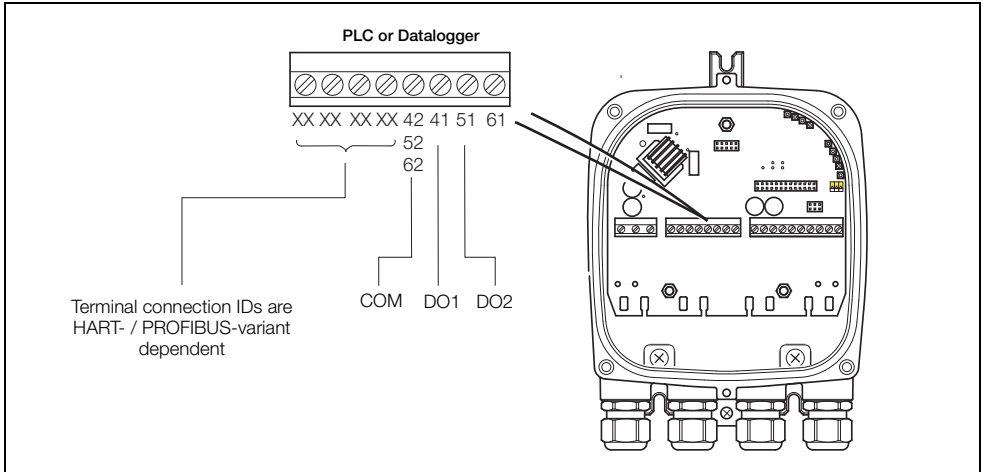

Fig. 3.6 PLC / Datalogger Connections

**Note.** Digital outputs DO1 and DO2 are polarity sensitive. The common (negative) connection for these outputs is designated 'COM'.

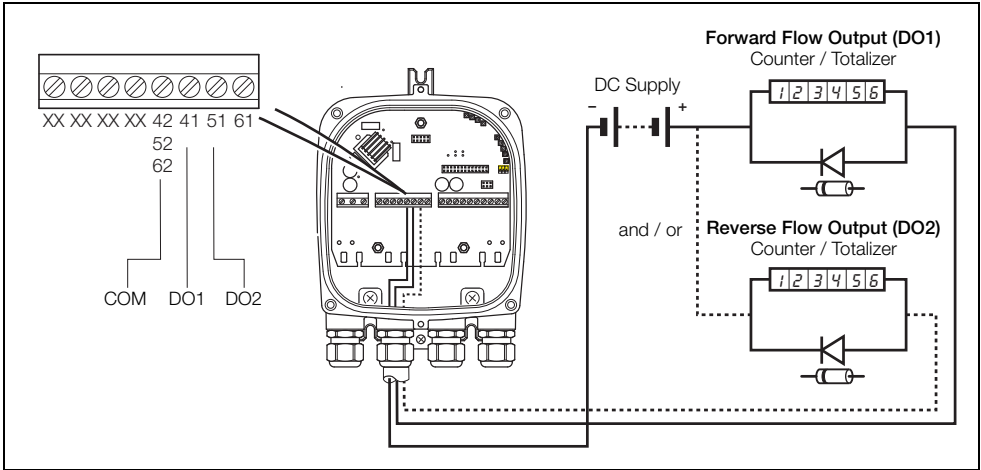

Fig. 3.7 Electromechanical Connections

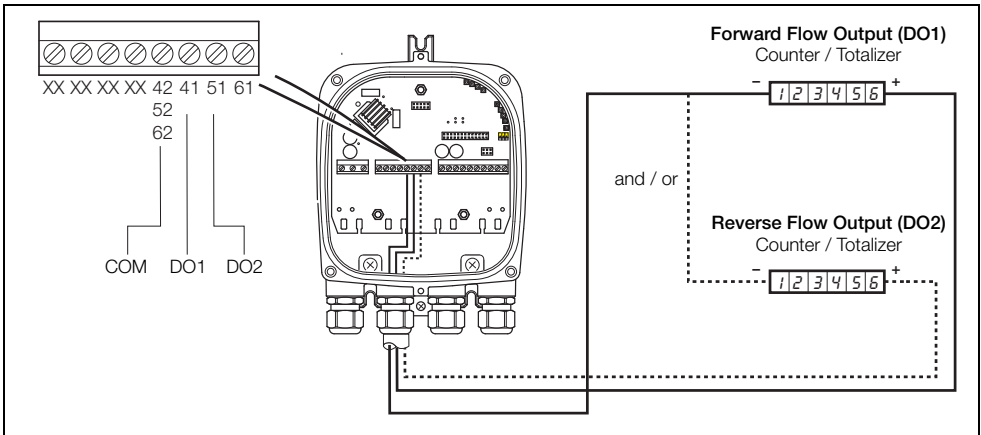

Fig. 3.8 Telemetry / Electronic Counters (etc.) Connections



### 3.5.2 Alarm Outputs

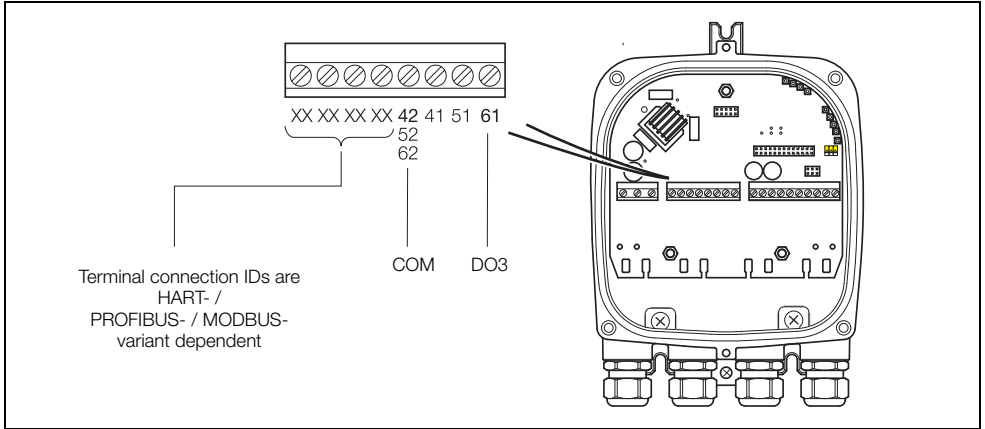

Fig. 3.9 Alarm Output Connections

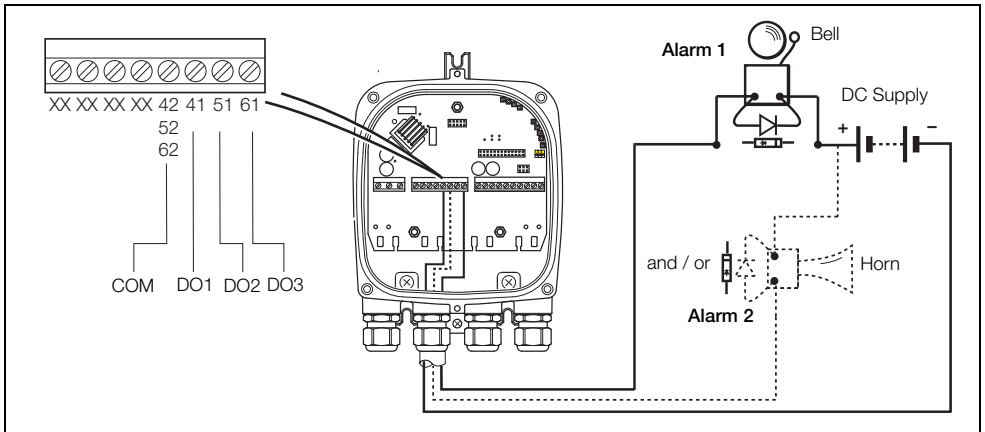

Fig. 3.10 Alarm Output Connections

**Note.**

- Normal alarm / logic output is from DO3 (terminal 61). DO1 (41) and DO2 (51) can also be configured as alarms if required but are then NOT available as frequency / pulse outputs as shown in Figs 3.7 and 3.8).
- Bell and horn shown for example only. Any suitable alarm device may be used (for example, lamp, siren, buzzer etc.).

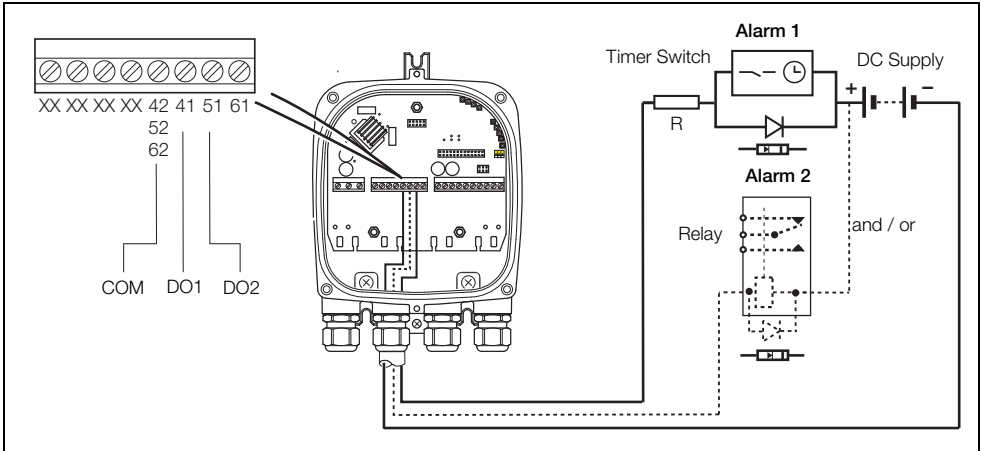

Fig. 3.11 Relay and Timers Output Connections

**Note.** Relay and timer switch shown for example only. Connect as required.

### 3.5.3 Contact Input

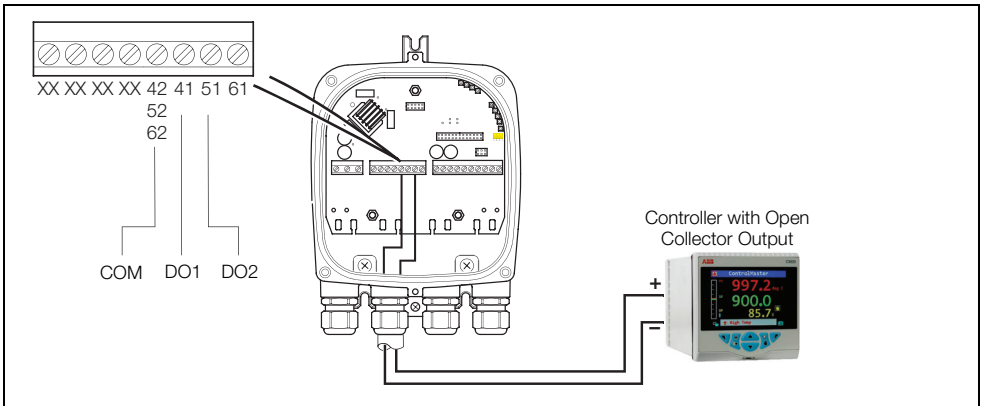

Fig. 3.12 Open Collector (or Grounded Contact) Connections

### 3.5.4 PLC Interface

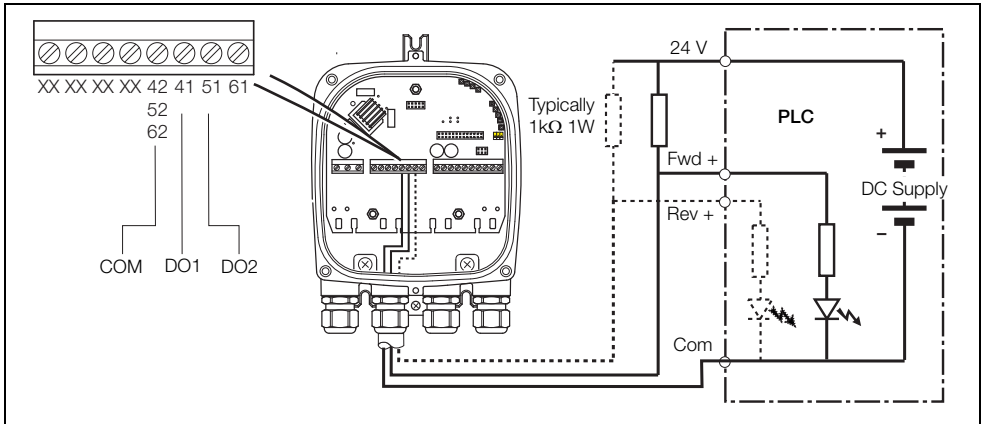

Fig. 3.13 PLC – Common –ve Connections

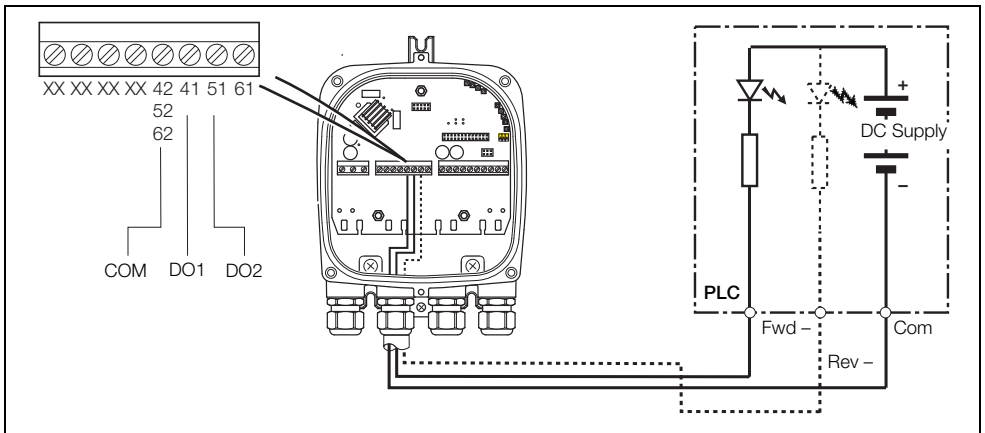

Fig. 3.14 PLC – Common +ve Connections

**Note.**

- WaterMaster digital outputs are NPN optocoupled transistors used as switches.
- Maximum allowed voltage at collector is 30 V DC
- Maximum allowed current across transistor is 220 mA.

### 3.5.5 Current Output (4 to 20 mA) – HART (FEX100) Variant

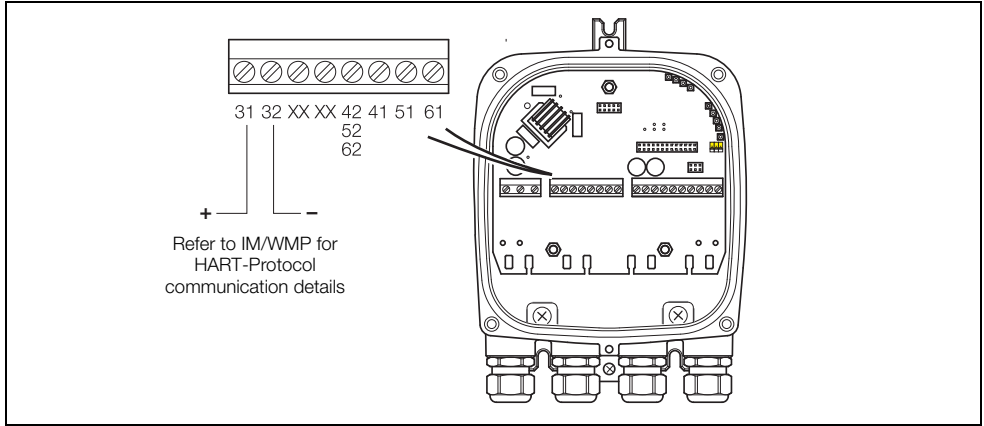

Fig. 3.15 Current Output (4 to 20 mA) – HART (FEX100) Variant

### 3.5.6 RS485 Communications – PROFIBUS (FEX100-DP) and MODBUS (FEX100-MB) Variants

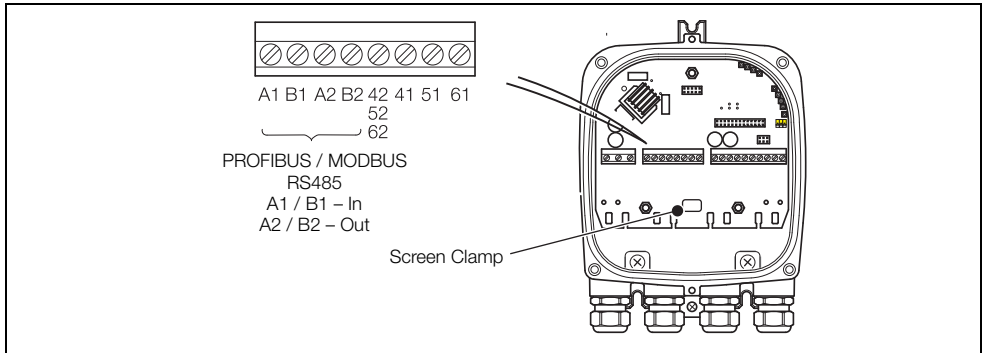

Fig. 3.16 WaterMaster RS485 Backplane Connections to PROFIBUS / MODBUS Networks

### 3.5.7 Test Point Access

**Note.** A typical DVM probe can access (fit) the PCB's test holes.

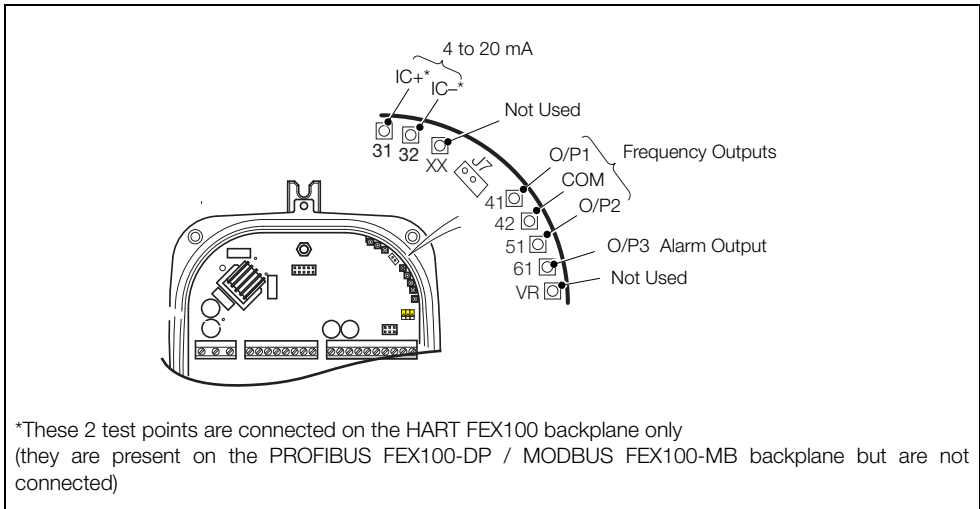

Fig. 3.17 Transmitter PCB Board Test Point Access

### 3.6 Power Supply Connections

#### Warning.

- Electrical installation and earthing (grounding) must be in accordance with relevant national and local standards.
- Power must be connected via a suitable isolator and fused in accordance with relevant standards.
- When changing fuses F1 or F2, isolate the power supply and wait 20 seconds before opening the enclosure.
- Replace fuses with the correct part – see Fig 3.18 (AC power) and 3.19, page 21 (DC power).

#### 3.6.1 AC Power Supply

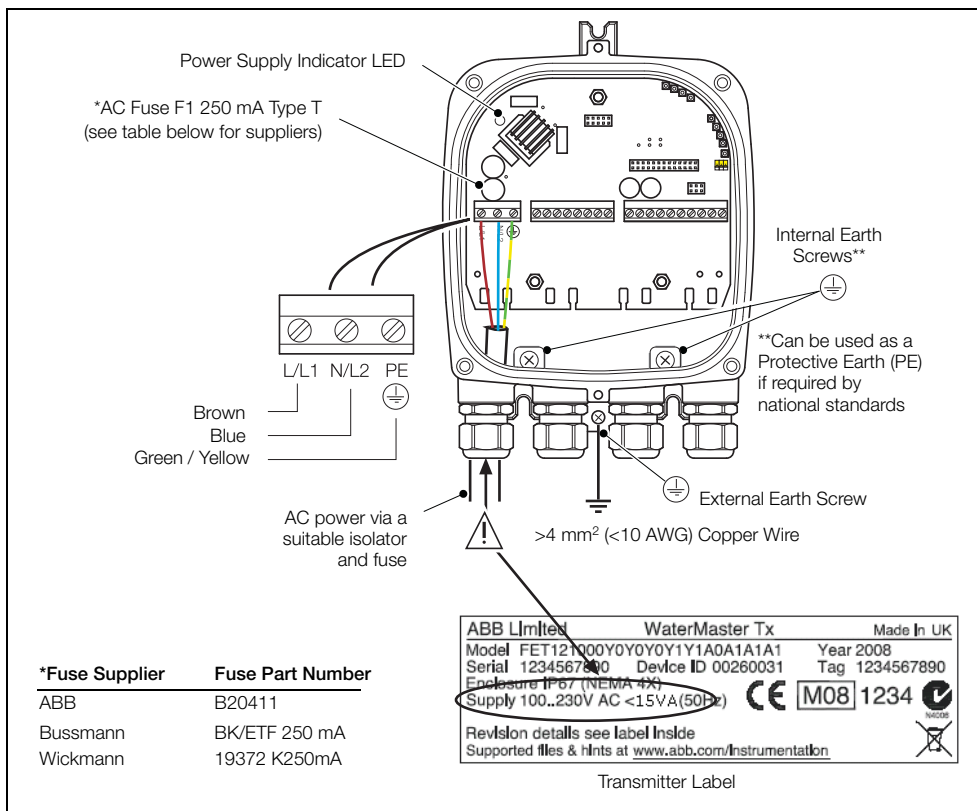

Fig. 3.18 AC Power Supply Connections

**3.6.2 DC (and Low Voltage AC) Power Supply**

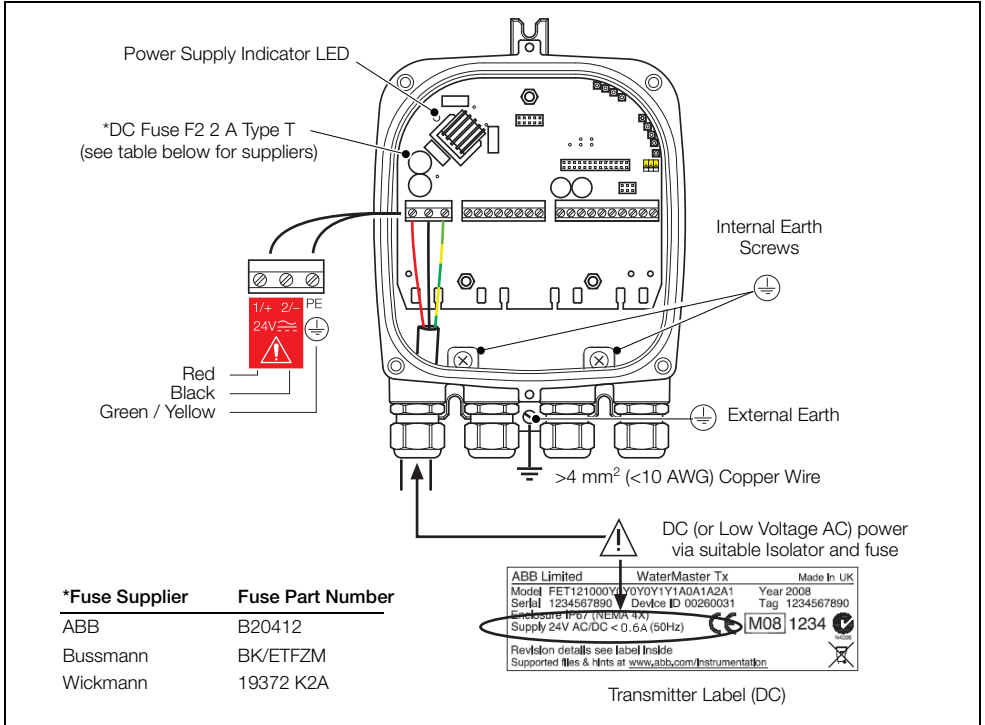

Fig. 3.19 DC (and Low Voltage AC) Power Supply Connections

### 3.6.3 Configuration DIP Switches

Three configuration DIP switches are mounted on the transmitter backplane board.

These are factory-set as follows:

- Remote transmitter – all OFF
- Integral transmitter – SW3 ON

For flowmeters ordered with the Measuring Instruments Directive (MID) option / variant it is a legal requirement that at the end of installation the flowmeter is sealed to prevent unauthorized changes to the meter settings and configuration. The read-only / MID protection switch, which prevents changes to any metrological parameter, must be set to 'ON' to ensure the meter is secure from tampering at the end of the meter installation.

For HART software versions prior to 01.02.XX, this switch (set after commissioning) prevents login via the keypad or bus at any security level.

From HART software version 01.03.XX onwards and for all PROFIBUS software versions, on MID meters, all metrological-related parameters are locked and inaccessible at the Service level. Standard and Advanced user level parameters can still be modified via the HMI or bus.

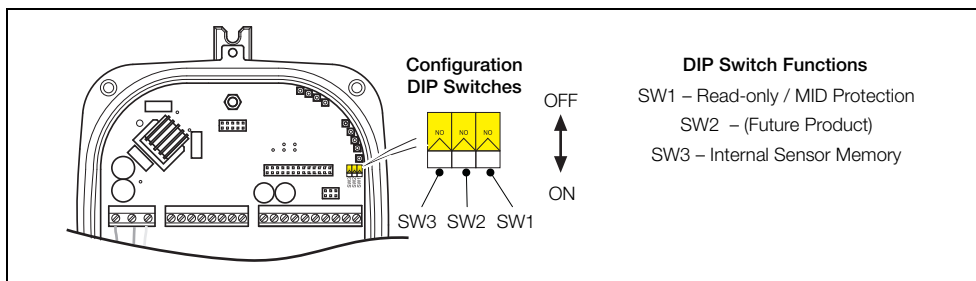

Fig. 3.20 Configuration DIP Switches

### 3.7 Refitting the Cartridge and Cover

**Warning.** Ensure the transmitter is isolated from power supplies before refitting the cover.

**Caution.**

- The communications bus type is HART FEX100 if not specified on the cartridge label. An example of the PROFIBUS FEX100-DP variant cartridge label is shown on the right.
- The cartridge communications type must match the communications type of the transmitter backplane PCB.
- To avoid damaging the cartridge during refitting, do not overtighten the cartridge screws.



PROFIBUS variant  
cartridge label



Referring to Fig. 3.21:

1. Confirm that the cartridge to be fitted is of the correct power supply and for the correct communications bus type (HART, PROFIBUS OR MODBUS) by checking the label (A) on the side of the cartridge:
  - AC cartridges have one **black** label on the cartridge side.
  - DC (and low voltage AC) cartridges have two **red** DC labels – one on the cartridge side and one on the cartridge rear plate.
2. Align the three cartridge screws (B) with the cartridge housing pillars and tighten the screws carefully until the cartridge is held in position.
3. If necessary, rotate the cartridge to the required orientation before refitting the cover – see Fig. 3.3, page 10 for details.
4. For high integrity / security installations, set DIP switch SW1 to the 'ON' (Read-only) position – see Fig. 3.20, page 22.
5. Align the transmitter cover with the housing and tighten the four cover screws (C) carefully.
6. For flowmeters ordered with the MID option or high integrity / security installations, it is a legal requirement that at the end of installation the flowmeter is sealed to prevent unauthorized modification or operation of the flowmeter. A suitable anti-tamper seal must be fitted to the security feature (D), such that in the event of unauthorized tampering, it is clearly visible if the fitted legal metrology seals have been broken.

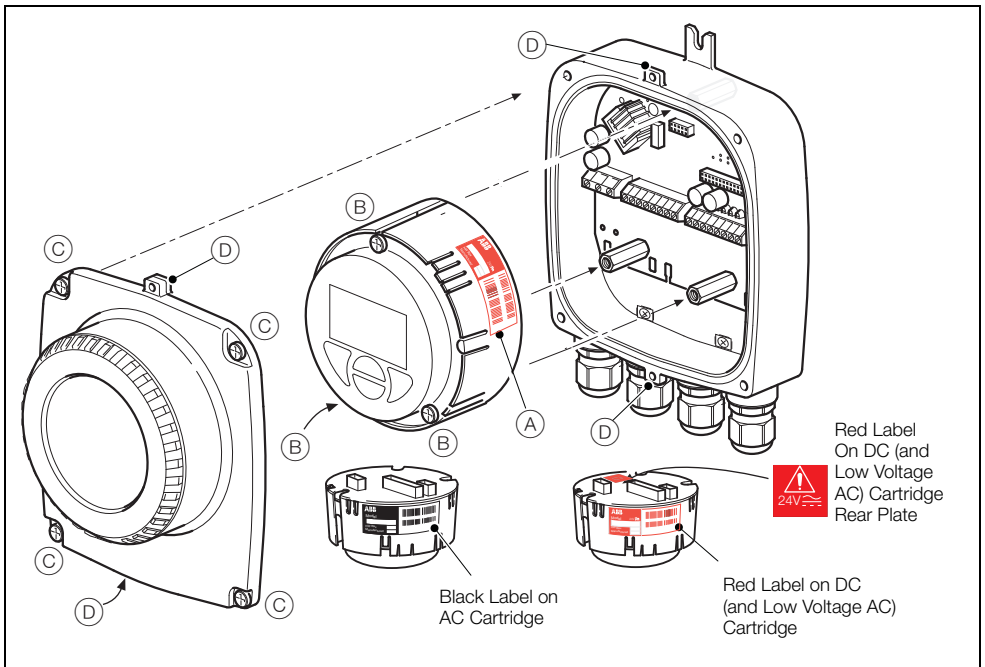

Fig. 3.21 Refitting the Cartridge and Cover

## 4 Start-up and Operation

**Note.** This section describes the options available at the 'Easy Setup' menu. Refer to the Programming Manual (IM/WMP) for comprehensive details of all end-user menus and operating levels.

### 4.1 Navigating the Menus and Parameters

The four keys below the display are used to navigate through the menus and to execute all system commands and selections.

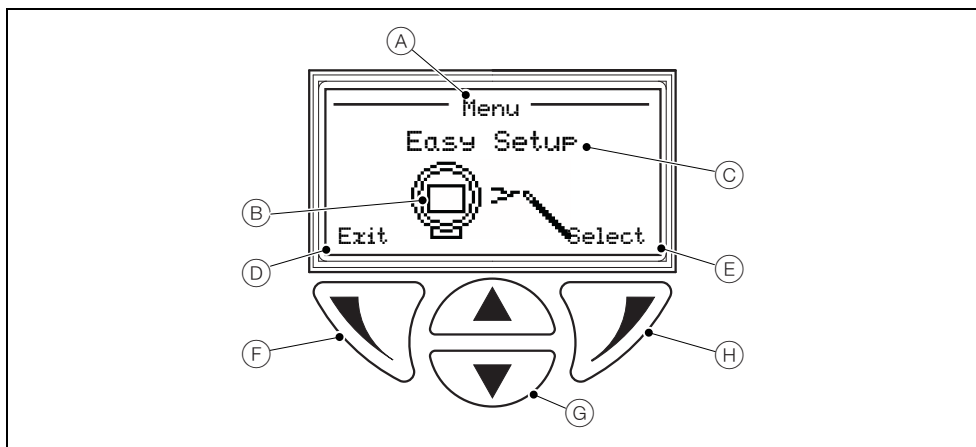



Fig. 4.1 Display and Keys

Item	Description
A	Screen title at the current level / parameter
B	Main level icon
C	Menu level title
D	Prompt executed by pressing the  key
E	Prompt executed by pressing the  key
F	Left key – used for parameter navigation and to enter editable parameters
G	Up / Down keys – used to scroll through menu options and to increase / decrease values in editable parameters
H	Right key – used to accept / select parameter values / selections and exit sub-levels

## 4.2 Start-up Screens

At start-up, the type of screen displayed indicates the status of the system.

There are four common start-up screen types as follows:

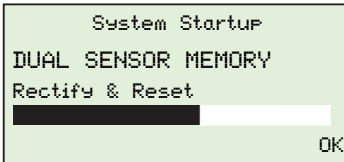
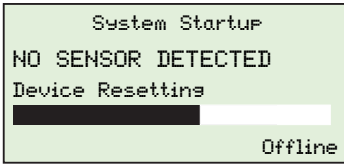
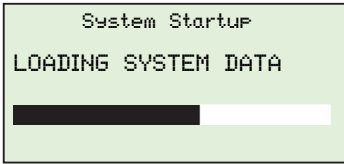

---

### System Start-up

At system start-up, a progress bar is displayed for the duration of the start-up period.

After this period, one of the four following screens is displayed according to the current status of the system.

---

### No Sensor Connected

If no sensor is detected during start-up, an auto-recovery routine is run to look for the sensor. If no sensor is detected, this routine continues until it is stopped manually.

If 'Offline' is selected during auto-recovery (by pressing the  key) the transmitter ceases to operate as a flowmeter and the following conditions apply at the transmitter:

- Plant and transmitter data can be configured.
- Sensor data cannot be configured.

**Note.** If this screen is displayed on an integral transmitter, check that DIP switch SW3 is in the 'ON' position (refer to Fig. 3.20, page 22).

---

### Dual Sensor Memory

Integral and retrofit systems have the sensor memory mounted on the transmitter backplane board.

If two sensor memory types (integral and remote) are detected at start-up, the warning 'DUAL SENSOR MEMORY' is displayed.

To correct this condition, set DIP switch SW3 to the 'OFF' position (refer to Fig. 3.20, page 22).

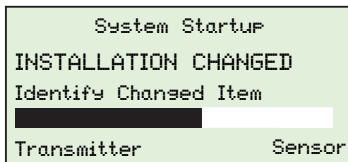

### Installation Changed

If the sensor data stored in the transmitter memory does not match the data of the connected sensor, the warning 'INSTALLATION CHANGED' is displayed.

The changed item(s) (transmitter or sensor) can be identified and data copied as follows:

#### Transmitter

Selecting this option copies plant and stack data from the sensor memory to the transmitter memory and loads the totalizer from the sensor memory.

It is used to make the following changes:

- Remote or integral cartridge change
- Remote Tx change
- New installation

#### Sensor

Selecting this option copies data from the transmitter memory to the sensor and loads the totalizer from the sensor memory.

It is used to make the following changes:

- Integral backplane change
- Sensor change
- Integral transmitter change

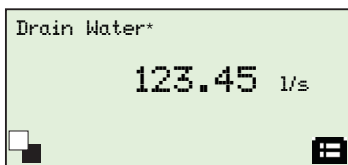

### Process Display (Operator Page)

When the 'Process Display' (Operator Page) is displayed, normal operation is assumed.

To access menus at a permitted access level, press the  key to display the 'Access Level' screen – see Section 4.3, page 27.

*\*Example legend only*

### 4.3 Security Levels and Password Access

At power-up, the 'Start-up Display' and 'Process Display' screens are activated in sequence.

**Note.**

- Passwords at 'Standard' and 'Advanced' level can be set and changed by end-users.
- Access to the 'Service' level is reserved for factory-only personnel and not available to end-users.
- To navigate from the 'Operator Page(s)' directly back to the menus, accept the default access level selection at the 'Access Level' screen and press the  key.

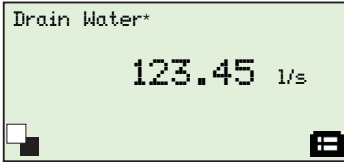

*\*Example legend only*

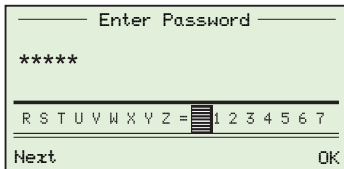
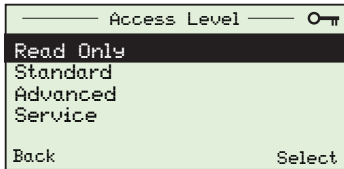

#### Operator Pages (Process Display)

When the start-up routine is completed, and if no changes have occurred since last start-up, the 'Process Display' (Operator Page) screen is displayed.

Press the  key to display the 'Access Level' screen where the level of user access is selected.

#### Access Level

Passwords are required for 'Standard' and 'Advanced' level access. Passwords are not required for 'Read Only' access.

Select the permitted level of access and press the  key to display the 'Enter Password' screen (the 'Enter Password' screen is bypassed if 'Read Only' is selected).

#### Enter Password

Enter the password and press the  key to display menus available at the permitted access level.

**Note.** If a time-out occurs (5 minutes of no activity), enter the password again to access the menus.

### 4.3.1 Default Passwords

The WaterMaster transmitter is supplied with default passwords for access to 'Standard' and 'Advanced' level menus.

The two passwords are:

- 'Standard' access password: 2 or blank
- 'Advanced' access password: 3 or blank







Passwords can contain up to 5 characters and are not case sensitive.

To prevent unauthorized access ABB recommend the default passwords are changed on commissioning.

**Note.** When allocating passwords, record a copy of each password and store in a safe location. It is not possible to interrogate the transmitter to 'recover' passwords once they have been set.

### 4.3.2 Entering Passwords

To select password characters and enter passwords:

1. Scroll to the 'Access Level' screen and select the required access level. Press the  key to display the 'Enter Password' screen.
2. Use the  and  keys to scroll to and highlight the first password character to be selected.
3. Press the  key to select the highlighted character (add it to the password set).
4. Use the  and  keys to highlight the next password character to be selected.
5. Repeat steps 2 to 4 until all characters have been added to the password.
6. Press the  key to accept the password and display menus available at the requested access level.



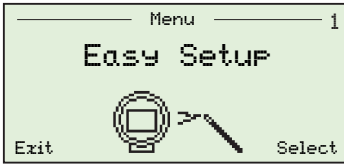









## 4.4 Easy Setup



### Easy Setup

The 'Easy Setup' level is used to set the system up quickly and contains a series of options for users with 'Standard' and 'Advanced' access permission. Users with 'Read Only' access cannot make selections at this level.

To navigate the 'Easy Setup' parameters:

- Enter 'Easy Setup' by pressing the  key at the 'Select' prompt.
- View and edit a parameter by pressing the  key at the 'Edit' prompt.
- Scroll parameter options by pressing the  and  keys (press and retain contact to scroll multiple options consecutively).
- Edit parameters by pressing the  key at the 'Next' prompt to enter the text field and press the  and  keys to increase or decrease the value. Press the  key at the 'OK' prompt to accept the new value.
- Accept a highlighted parameter by pressing the  key at the 'OK' prompt.
- Exit the current parameter without changing the setting by pressing the  key at the 'Cancel' prompt.
- Move to the next parameter by pressing the  key at the 'Next' prompt.
- Exit 'Easy Setup' level by pressing the  key at the 'Exit' prompt on the 'Easy Setup' main level screen.

Parameter	Range	[Default] Note
Language	English, Deutsch, Français, Español, Italiano, Polski, Portuguese	[English] Selectable
Q (Flowrate) Unit	m <sup>3</sup> /s, m <sup>3</sup> /min, m <sup>3</sup> /h, m <sup>3</sup> /d, ft <sup>3</sup> /s, ft <sup>3</sup> /min, ft <sup>3</sup> /h, ft <sup>3</sup> /d, ugal/s, ugal/min, ugal/h, ugal/d, Mugal/d, ical/s, ical/min, ical/h, ical/d, bls/s, bls/min, bls/h, bls/d, hl/h, ml/s, ml/min, l/s, l/min, l/h, Ml/d,	[m <sup>3</sup> /h] Selectable
Qmax	Dependent on sensor size	[Factory set]
Volume & Pulse Unit	m <sup>3</sup> , l, ml, ft <sup>3</sup> , hl, ical, ugal, bls, MI, Mugal	Selectable*
Pulse Width	0.09 to 2000.00 ms	[0.09 ms] Editable
Pulses / Unit	0.000010 to 10,000,000 pulses / unit	[1.0] Editable (Only shown when Pulse Mode is Pulse / Unit)
Fullscale Frequency	0.250000 to 10,000,000 Hz	[5,000.000] Editable (Only shown when Pulse Mode is Fullscale Frequency)
Damping	0.02 to 60 s	[3.00 s] Editable
Mains Frequency	50 or 60 Hz	[50 Hz] Selectable

\* For OIML and MID flowmeters, only m<sup>3</sup> must be used.



## 5 Specification

### Functional Specification

#### Power supply

Mains	85 to 265 V AC @ <7 VA
Low voltage	24 V AC +10 %/-30 % @ <7 VA
DC	24 V $\pm$ 30 % @ <0.4 A

Supply voltage fluctuations within the specified range have no effect on accuracy

#### Digital outputs (3 off)

- Rating 30 V @ 220 mA, open collector, galvanically isolated
- Maximum output frequency 5250 Hz
- 1 off dedicated to Alarm / Logic, programmable function
- 2 off configurable to either Pulse / Frequency or Alarm/Logic function

#### Current output – HART FEX100 variant

- 4 to 20 mA or 4 to 12/20 mA, galvanically isolated (when installed, do not leave galvanically isolated circuits [pulse and current] floating)
- Maximum loop resistance 750  $\Omega$
- HART protocol Version 5.7 (HART registered)
- Signal levels compliant with NAMUR NE 43 (3.8 to 20.5 mA)
- Low alarm 3.6 mA, High alarm 21.8 mA

#### Additional accuracy

- $\pm$ 0.1 % of reading
- Temperature coefficient: typically  $<\pm$ 20 ppm/ $^{\circ}$ C

#### RS485 communications – PROFIBUS FEX100-DP variant

- Registered name: FEX100-DP
- RS485 (9.6kbps to 1.5Mbps), galvanically isolated
- DPV0, DPV1
- PA Profile 3.01
- Standard idents: 9700, 9740, 9741
- FEX100-DP specific ident: 3431
- 3 Concurrent MS2 master connections

#### RS485 communications – MODBUS FEX100-MB variant

- MODBUS RTU protocol
- RS485 (9.6kbps to 115.2kbps), galvanically isolated

#### Electrical connections

- 20 mm glands, 1/2 in NPT, 20 mm armored glands

#### Temperature limitations

- Ambient temperature -20 to 60  $^{\circ}$ C (-4 to 140  $^{\circ}$ F)
- Temperature coefficient Typically  $<\pm$ 10 ppm/ $^{\circ}$ C @ Vel  $\geq$ 0.5 m/s

### Environmental protection

Humidity: 0 to 100 %

Rating: IP67 (NEMA 4X) to 1m (3.3 ft) depth

### Tamper-proof security

Write access prevented by internal switch combined with external security seals for MID applications

### Languages

English, French, German, Italian, Spanish, Polish

### Infrared service port

USB adapter (accessory), USB 1.1. and 2.0 compatible

Driver software for Windows 2000, XP, 7 (32-bit) and Vista

### Housing material

Powder-coated aluminium with glass window

### Paint specification

Paint coat  $\geq 70 \mu\text{m}$  thick RAL 9002 (light grey)

### Transmitter vibration testing

Vibration level:  $7 \text{ m/s}^2$

Frequency range: 20 to 150 Hz

No. of sweeps in 3 orthogonal planes: 20

Undetectable shift in transmitter span or zero performance

### Hazardous approvals (HART variant only)

FM & FMc Class 1 Div 2

(FM listing NI / 1 / 2 / ABCD / T4, S / II, III / 2 / FG / T4,  
Ta=60C; Type 4X, IP67 – for transmitter and integral mounting  
Ta=70C, Type 6P, IP68 – for remote sensor type,  
IP67 on DN10 to 32)

(FMc listing NI / 1 / 2 / ABCD / T4, DIP / II, III / 2 / FG / T4,  
Ta=60C; Type 4X, IP67 – for transmitter and integral mounting  
Ta=70C, Type 6P, IP68 – for remote sensor type, IP67 on DN10 to 32)

FET, FEV, FEW and FEF DN700 to 2200 (27/28\* to 84) only – size is dependent on flange specification

ATEX\* Zone 2, 21 & 22

II 3 G Ex nA IIC T5 Gc

II 2 D Ex tb IIIC T100°C Db

TA = -20°C to +60°C (integral transmitter)

TA = -20°C to +70°C (remote sensor)

IECEX\* Zone 2, 21 & 22

Ex tb IIIC T100°C Db

Ex nA IIC T5 Gc

TA = -20°C to +60°C (integral transmitter)

TA = -20°C to +70°C (remote sensor)

\*FEW, FEV, FET and FEF  $\geq 700$  (27/28 in. NB) only

### Declaration of Conformance

Copies of CE and PED certification will be available on request.

WaterMaster has OIML R49 Certificate of Conformity to accuracy class 1 and 2 (FEV DN40 to 200).

Copies of accuracy certification are available on request.

WaterMaster (FEV DN40 to 200) has been type examined under directive MID 2004/22/EC, Annex MI-001.

Copies of this certificate are available on request.

## Acknowledgments

- Microsoft and Excel are registered trademarks of Microsoft Corporation in the United States and/or other countries.
- Modbus is a registered trademark of Schneider Electric USA Inc.
- HART is a registered trademark of the FieldComm Group.
- PROFIBUS is a registered trademark of PROFIBUS organization.

Sales



Service



---

**ABB Limited**  
**Measurement & Analytics**

Oldends Lane  
Stonehouse  
Gloucestershire  
GL10 3TA  
UK  
Tel: +44 (0)1453 826 661  
Fax: +44 (0)1453 829 671  
Email: instrumentation@gb.abb.com

**ABB Limited**  
**Measurement & Analytics**

125 E County Line Road  
Warminster  
PA 18974  
USA  
Tel: +1 215 674 6000  
Fax: +1 215 674 7183

**[abb.com/measurement](http://abb.com/measurement)**

**ABB Engineering (Shanghai) Ltd.**  
**Measurement & Analytics**

No. 4528, Kangxin Highway  
Pudong New District  
Shanghai  
201319  
P.R. China  
Tel: +86(0) 21 6105 6666  
Fax: +86(0) 21 6105 6677  
Email: china.instrumentation@cn.abb.com



---

We reserve the right to make technical changes or modify the contents of this document without prior notice. With regard to purchase orders, the agreed particulars shall prevail. ABB does not accept any responsibility whatsoever for potential errors or possible lack of information in this document.

We reserve all rights in this document and in the subject matter and illustrations contained therein. Any reproduction, disclosure to third parties or utilization of its contents – in whole or in parts – is forbidden without prior written consent of ABB.