



—  
EPMV SWITCHGEAR

**SafeGear®**

**5/15 kV arc-resistant switchgear**

Installation, operations and maintenance manual





EPMV SWITCHGEAR

**SafeGear®**

**5/15 kV arc-resistant switchgear**

Installation, operations and maintenance manual

---

## NOTICE

This document contains information about one or more ABB products and may include a description of or a reference to one or more standards that may be generally relevant to the ABB products. The presence of any such description of a standard or reference to a standard is not a representation that all of the ABB products referenced in this document support all of the features of the described or referenced standard. In order to determine the specific features supported by a particular ABB product, the reader should consult the product specifications for the particular ABB product.

ABB may have one or more patents or pending patent applications protecting the intellectual property in the ABB products described in this document.

The information in this document is subject to change without notice and should not be construed as a commitment by ABB. ABB assumes no responsibility for any errors that may appear in this document.

Products described or referenced in this document are designed to be connected and to communicate information and data through network interfaces, which should be connected to a secure network. It is the sole responsibility of the system/product owner to provide and continuously ensure a secure connection between the product and the system network and/or any other networks that may be connected.

The system/product owners must establish and maintain appropriate measures, including, but not limited to, the installation of firewalls, application of authentication measures, encryption of data, installation of antivirus programs, and so on, to protect these products, the network, its system, and interfaces against security breaches, unauthorized access, interference, intrusion, leakage, and/or theft of data or information.

ABB performs functionality testing on the products and updates that we release. However, system/product owners are ultimately responsible for ensuring that any product updates or other major system updates (to include but not limited to code changes, configuration file changes, third-party software updates or patches, hardware change out, and so on) are compatible with the security measures implemented. The system/product owners must verify that the system and associated products function as expected in the environment in which they are deployed.

In no event shall ABB be liable for direct, indirect, special, incidental or consequential damages of any nature or kind arising from the use of this document, nor shall ABB be liable for incidental or consequential damages arising from use of any software or hardware described in this document.

This document and parts thereof must not be reproduced or copied without written permission from ABB, and the contents thereof must not be imparted to a third party nor used for any unauthorized purpose.

The software or hardware described in this document is furnished under a license and may be used, copied, or disclosed only in accordance with the terms of such license. This product meets the requirements specified in EMC Directive 2014/30/EU and in Low Voltage Directive 2014/35/EU.

---

## TRADEMARKS

SafeGear is a registered trademark of ABB

All rights to copyrights, registered trademarks, and trademarks reside with their respective owners.

Copyright © 2017 ABB.

All rights reserved.

Release: October 2017

Document number: 1VAL108002-MB Rev C

**TABLE OF CONTENTS**

<b>1. IMPORTANT SAFETY NOTES &amp; WARNINGS .....</b>	<b>7</b>
<b>1.1 Safety Notations .....</b>	<b>7</b>
<b>2. INTRODUCTION .....</b>	<b>9</b>
<b>2.1 General instructions .....</b>	<b>9</b>
<b>2.2 Scope of Instructions.....</b>	<b>9</b>
<b>3. RECEIVING, HANDLING AND STORAGE .....</b>	<b>10</b>
<b>3.1 Receiving Inspection.....</b>	<b>10</b>
<b>3.2 Handling the Equipment.....</b>	<b>10</b>
<b>3.3 Storing the Equipment .....</b>	<b>10</b>
<b>4. SITE PREPARATION .....</b>	<b>12</b>
<b>4.1 General.....</b>	<b>12</b>
<b>4.2 Location.....</b>	<b>12</b>
<b>4.3 Foundation .....</b>	<b>12</b>
<b>5. INDOOR INSTALLATION .....</b>	<b>13</b>
<b>5.1 General.....</b>	<b>13</b>
<b>5.2 Removal of the Shipping Base.....</b>	<b>18</b>
<b>5.3 5.3 Attaching to the Floor.....</b>	<b>19</b>
<b>5.4 5.4 Connections .....</b>	<b>21</b>
<b>5.5 Connection to Ground Bus .....</b>	<b>33</b>
<b>5.6 Installation of the Plenum .....</b>	<b>33</b>
<b>5.7 Installation of Bus Bar Connections between Shipping Splits .....</b>	<b>34</b>
<b>5.8 Secondary and Control Connections .....</b>	<b>35</b>
<b>5.9 Primary Cable Connections .....</b>	<b>35</b>
5.9.1 Bus Boot Installation .....	35
<b>5.10 Connection to Control Source.....</b>	<b>42</b>
<b>5.11 Circuit Breaker: Insertion and Removal.....</b>	<b>42</b>
5.11.1 Insertion.....	43
5.11.2 Removal.....	48
<b>5.12 Auxiliary Modules .....</b>	<b>49</b>
5.12.1 Insertion.....	50
5.12.2 Removal.....	51
<b>5.13 Setting the 2000A and 3000A Vent Flaps .....</b>	<b>51</b>
<b>5.14 Defeating Front Door Interlock (optional feature) .....</b>	<b>53</b>
<b>5.15 Adjusting the front door .....</b>	<b>53</b>

<b>5.16</b>	<b>Mounting Rear Doors .....</b>	<b>54</b>
5.16.1	Bolted/Hinged Doors w/inner panels .....	54
5.16.2	Bolted/Hinged Doors w/o inner panels.....	55
<b>6.</b>	<b>TESTING AND FINAL INSPECTION .....</b>	<b>56</b>
<b>6.1</b>	<b>Testing.....</b>	<b>56</b>
<b>6.2</b>	<b>Control Circuit Checkout.....</b>	<b>57</b>
<b>6.3</b>	<b>Final Inspection .....</b>	<b>59</b>
<b>7.</b>	<b>PLACING SWITCHGEAR INTO SERVICE – SAFETY PRECAUTIONS.....</b>	<b>60</b>
<b>7.1</b>	<b>Energizing the Main Bus .....</b>	<b>60</b>
<b>8.</b>	<b>STANDARD CONSTRUCTION .....</b>	<b>61</b>
<b>8.1</b>	<b>Standard Color .....</b>	<b>61</b>
<b>8.2</b>	<b>Galvanized Steel Frame Construction .....</b>	<b>61</b>
<b>8.3</b>	<b>Bus Support Insulation .....</b>	<b>61</b>
<b>8.4</b>	<b>Primary Disconnect Assemblies.....</b>	<b>61</b>
<b>8.5</b>	<b>Secondary Disconnecting Devices.....</b>	<b>61</b>
<b>8.6</b>	<b>Ground Bus Contacts.....</b>	<b>62</b>
<b>8.7</b>	<b>Control Wires.....</b>	<b>62</b>
<b>9.</b>	<b>MAINTENANCE.....</b>	<b>63</b>
<b>9.1</b>	<b>General.....</b>	<b>63</b>
<b>9.2</b>	<b>Annual Inspection.....</b>	<b>63</b>
<b>9.3</b>	<b>24 Month (Two Year) Inspection.....</b>	<b>65</b>
<b>9.4</b>	<b>10 Year Maximum Inspection .....</b>	<b>65</b>
<b>9.5</b>	<b>Bolted Joint Maintenance.....</b>	<b>66</b>
<b>9.6</b>	<b>Care of Finish.....</b>	<b>66</b>
<b>9.7</b>	<b>Renewal Parts .....</b>	<b>66</b>
<b>9.8</b>	<b>End of life of Product.....</b>	<b>67</b>
<b>9.9</b>	<b>Disclaimer of Warranties and Limitation of Liability.....</b>	<b>68</b>
<b>10.</b>	<b>APPENDIX A – TORQUE REQUIREMENTS FOR SAE GRADE 5 STEEL HARDWARE .....</b>	<b>69</b>
	<b>REVISION HISTORY .....</b>	<b>1</b>

## 1. IMPORTANT SAFETY NOTES & WARNINGS

Equipment operation depends on proper handling, installation, and maintenance. Neglecting fundamental requirements may lead to injury of personnel, failure of the equipment and property damage.

Safety as described in this instruction book involves two conditions:

- Personal injury
- Product or property damage

### 1.1 Safety Notations

Safety notations alert personnel to possible death, injury or property damage situations. The safety notations appear before the step in which the condition applies. The one safety notice and three hazard levels notations are:

<b>⚠ DANGER</b>	
<b>“Danger” indicates a hazardous situation that has a high probability of death, severe injury, and substantial property damage</b>	

<b>⚠ WARNING</b>	
	<b>“Warning” indicates a hazardous situation that has some probability of severe injury and substantial property damage</b>

<b>⚠ CAUTION</b>	
<b>“Caution” indicates a hazardous situation that may result in minor injury and/or property damage</b>	

# NOTICE

**“Notice” indicates a statement of company policy as it relates to the safety of personnel or protection of property**

Personnel installing, operating, or maintaining this equipment must have thorough knowledge of all applicable local, regional, industry, government, and OSHA safety procedures as well as commonly accepted safe working practices. Personnel working in or around this equipment must also exhibit common sense and good judgment regarding the potential hazards for themselves and other personnel in the area. These instructions are intended for use by fully qualified personnel and are not a substitute for adequate training, experience and supervision.

Should clarification or additional information be required, refer the matter to your nearest ABB Sales office. When communicating with ABB regarding the product covered by this IOM Manual, always reference the ABB assigned Order number.



## **2. INTRODUCTION**

### **2.1 General instructions**

Read these instructions carefully before installation and use as a guide during installation and initial operation.

File these instructions with other instruction books, drawings and descriptive data of the switchgear. Keep this book available for the installation, operation and maintenance of this equipment. Use of these instructions will facilitate proper maintenance of the equipment and prolong its useful life.

### **2.2 Scope of Instructions**

The instructions are general in nature. They cover requirements for installation, setup, checkout and maintenance as applied to all ratings of ABB SafeGear® medium voltage, arc-resistant, switchgear. These instructions do not attempt to cover all variations and combinations of equipment and installations.

Information on particular installations appears in the following:

- Bills of Materials that list electrical devices and equipment
- Single line drawings showing power connections
- Floor plan, representing available space for power & control conduits
- Special construction details
- Elementary and schematic diagrams
- Connection diagrams

### 3. RECEIVING, HANDLING AND STORAGE

#### 3.1 Receiving Inspection

Before shipment, the equipment is inspected and marked with its number and position. Switchgear frames are factory- assembled and shipped with the doors closed. The factory ships circuit breakers in separate cartons, or as an option, inside the switchgear frame with the breakers in disconnect position.

Upon receipt of the equipment, examine the shipment for damage or missing components. Check the contents against the packing list before discarding any packing material. Check the consignment for completeness and lack of any damage (e.g. moisture and its detrimental effects). In case of doubt, the packing must be opened and then properly resealed, putting in new drying agent bags, when intermediate storage is necessary.

If any quantities are short, or defects or transport damage are noted, these must be documented on the respective shipping document. Notify ABB and the carrier at once of any discrepancies. If there is damage from improper handling, file a claim for damages at once with the carrier and notify ABB.

Note: Always take photographs to document any damage.

Note: Unless otherwise noted in the project contract documents, ABB standard shipments are “FOB Factory.” ABB is not responsible for damage, after delivery of the equipment to the carrier.

#### 3.2 Handling the Equipment

Transport panels upright. Take the high center of gravity into account. Carry out loading operations only when it has been ensured that all precautionary measures to protect personnel and materials have been taken into consideration.



#### 3.3 Storing the Equipment

Leave the equipment on the shipping base.

Store all equipment indoors in a well- ventilated area.

The storage building should have a well- drained paved floor. The temperature should be above 60°F. The air should be dry (60% maximum humidity).

The shipping sections are wrapped in plastic for protection during shipment only. Remove the plastic wrap after placing into storage. Cover with heavy wrapping paper or other moisture barrier. Use materials that will not trap moisture inside the unit. Do not cover louvered openings.

For long term storage, durations exceeding two weeks, or in high-humidity areas, use heaters to keep the interior dry. Bring power for the heaters to the load terminals of the device that controls the heater circuits.



Heater load terminals in low voltage compartment (typ.)

Note: The protective breaker in the space heater circuit must remain open when using a separate power source during storage.

For circuit breakers shipped in crates, store circuit breakers upright in their original shipping carton oriented as indicated on the shipping crates. For circuit breakers shipped in the switchgear, do not remove for storage. See documents 1VAL050503-MB and 1VAL108002-MB for details on ADVAC and AMVAC breaker storage respectively.

## NOTICE

**Before energizing the heaters, remove all the packing materials from the switchgear. Open the breaker or cutout device that controls the heaters when using a separate power source**

## 4. SITE PREPARATION

### 4.1 General

Before installing, consult all drawings furnished for the particular order. The drawings show top, front and section views of the lineup, primary and secondary connection diagrams, and Bills of Materials. Study these drawings and the following recommendations before preparing the site plan drawings. On commencement of installation on site, the switchgear room must be completely finished, provided with lighting and the electricity supply, be lockable, dry and have facilities for ventilation. All the necessary preparations, such as wall openings, ducts, etc., for positioning the power and control cables up to the switchgear must already be complete.

The ceiling height must also be checked considering the top-mounted plenum and ventilation mechanisms.

### 4.2 Location

Locate the lineup in accordance with local regulations. Clearances at the front should allow for installation and removal of the drawout equipment. A minimum of 6 feet is recommended. Provide rear access for making connections before start-up and for periodic inspections and maintenance of 4 feet minimum.

### 4.3 Foundation

The ABB factory supplies General Arrangement and Floor Plan drawings for each installation. Refer to these drawings for floor leveling requirements. The finished floor under and in front of the switchgear line-up should be smooth, and shall not extend upwards above the switchgear floor line. Minimum floor leveling requirements are +0.0" to -0.25" over a linear distance of 20 feet.

For installations with concrete floors, install all power and secondary (control) conduits before moving the units to the site. Available space for the conduits appears on the floor plan drawings supplied with the switchgear. Conduits should not extend more than one inch above the station floor level. Plug conduit openings before pouring concrete.

For installations with steel floors, i.e., prefabricated metal buildings, cutouts for cable entry should not extend outside the space provided in the SafeGear frames as shown on the floor plan drawings.

## 5. INDOOR INSTALLATION

### 5.1 General



In order to obtain an optimum installation sequence and ensure high quality standards, site installation of the switchgear should only be carried out by specially trained and skilled personnel.

Metal-clad switchgear ships in sections. These sections ship on disposable steel shipping bases. Equipment is not to be permanently installed on the shipping bases.

Unload the units as close to the installation site as possible. Remove all drawout elements and secure all doors and panels. To move the shipping sections to their final position, one of 4 methods can be used.

Forklift – place forks through locations provided in the shipping bases.

Forklift provisions in shipping channels



Forklift forks penetrating shipping channels



Make sure that forks have penetrated the entire depth of the switchgear to engage all 3 shipping channels: front, center and rear.



**Complete fork penetration of all 3 shipping channels**

Lift the switchgear frames slowly and tilt forks slightly rearward to balance. Move carefully into the final position taking into account the center of gravity.



**Lifting of switchgear frames with forklift**

Towing - use chains rated for safe handling of the shipping splits. Consult the chain manufacturer or local code requirements for proper safety factors. Attach the chains to the holes at each end of the shipping base. Secure chains to the towing equipment. Make sure that the floor height is consistent or provide heavy duty steel sheets to bridge any inconsistencies. Protect the lower edge of the switchgear from damage by the chains.

Jacks and Rollers - raise the units with jacks located at the corners of the shipping bases.



**Placement of jacks at the corners with rollers under the shipping bases**

Move the units on steel pipe rollers with the shipping bases attached by pushing in one direction while another person puts an additional roller under the forward end. As rollers reach the rear, they can be moved to the front until the unit is in place.



**Movement of the frames with rollers**

For lateral moving, raise the units by jacks as described previously and place the rollers laterally with steel channels (not furnished) on the rollers. Carefully push the unit onto a third roller and move a roller from the rear to the front until the unit is in place.



Position rails as shown for lateral movement



Lateral movement of the frames with rollers

## **⚠ CAUTION**

**Use of fork lift trucks for jacking or placing the jacks other than as described may result in stress distortions and irreparable damage to the equipment.**

Lifting with a Crane:

Install lifting extensions with all four bolts – one on each corner of the shipping split.

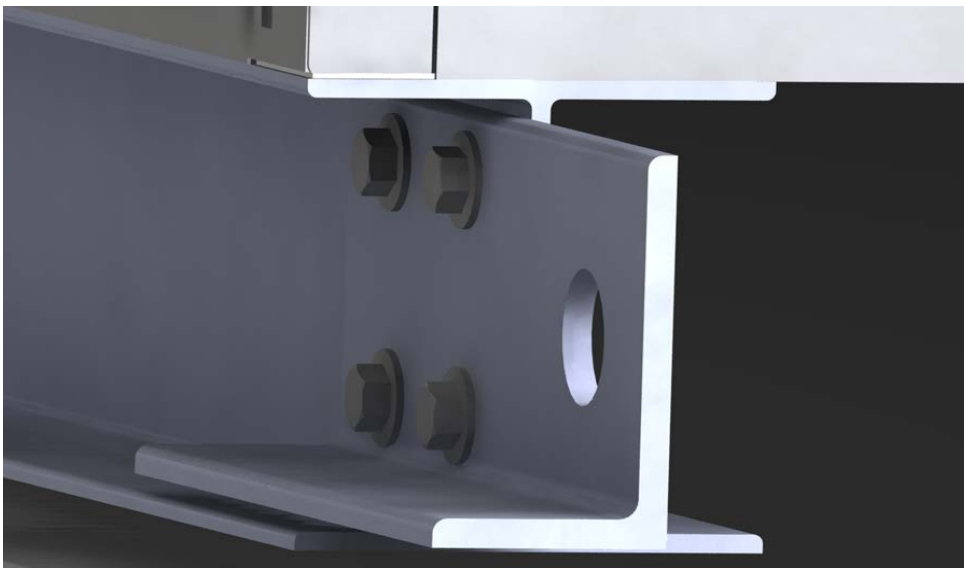



Repeat for all four corners.



Use the large holes in the lifting eye extensions to connect to the spreader bar (not provided)

## **⚠ CAUTION**

**The following diagram is for illustration purposes only**

**Always use the “lifting eye extensions” Do not lift directly from the lifting eyes**

**Sizing and supply of spreader bar, cables and other lift hardware is responsibility of others**

**Sling arrangement should be adjusted to allow for a level lift**

**Sling arrangement should be adjusted so the cable is NOT less than 60° to base**

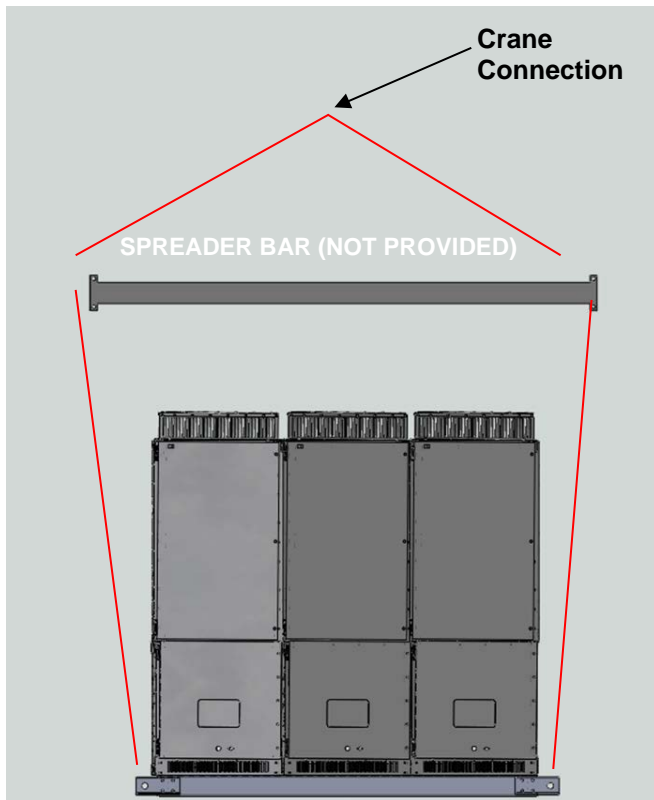

## **⚠ CAUTION**

**Do not remove the shipping bases until the units are set in place. Moving the units without the shipping base can cause irreparable damage and a hazardous condition**

### **5.2 Removal of the Shipping Base**

Once the units are in their final place, the shipping bases can be removed.

Open the equipment doors. Remove the bolts holding each of the three shipping bases to the equipment floor plates. If circuit breakers were installed for shipment, the lower position breakers will need to be removed prior to this step.



**Unbolting the shipping bases**

Close and secure all doors and panels. Raise the units to a height that allows removal of the base. Use four jacks located at each corner of the shipping split, just inside of the shipping bases for this operation. Keep the units uniformly level to prevent distortion.

Select four pieces of wood thick enough to permit removal of the jack after lowering. Place one under each corner. Slowly lower one side until it rests on the pieces of wood. Repeat this process on the other side.

Use a pry-bar to lift each corner enough to remove the four pieces of wood.



**Jacks lower the frames onto wood blocks  
a pry bar to remove the wood blocks**



**Using**

### 5.3 Attaching to the Floor

Following the removal of the shipping bases, the switchgear units should be secured to the floor either by bolting or welding per the guidelines outlined on the ABB factory drawings.

For accessibility Type 2BC installations, set the ventilation vanes above 2000A and 3000A breaker compartments in the vent chamber prior to bolting the shipping splits together. The vanes should be in the vertical position and locked firmly into place with the spring clips.



Breaker module ventilation vanes for Type 2BC

**⚠ CAUTION**

**Failure to set the vanes in the open position can cause the circuit breaker to overheat.**

## 5.4 Connections

**⚠ DANGER**

**Before making primary source connections, verify that the primary cables are de-energized and the equipment is properly grounded**

Bolting the separate units/shipping splits together:

Remove the 8 flange bolts shown in the picture below from the bus support that is installed between the two frames to be assembled together



**Note:** Only remove the bolts circled, DO NOT remove the two smaller bolts or the bus support from the frame. The flange bolts will be reinstalled from inside the other frame.

Open the LV or compartment door and the breaker door on the right frame from the front. Insert a flange bolt in every hole in the right side that is aligned with a tinnerman nut in the left side. Use the following bolt layout to guide you on which holes to use.

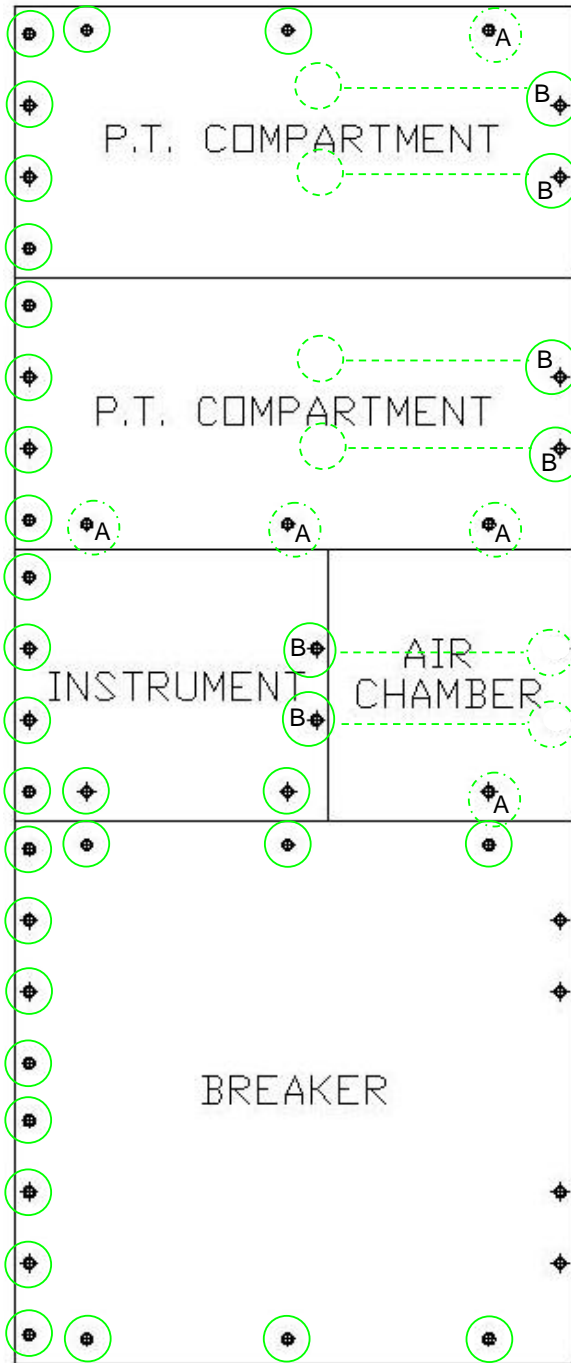

**Notes:**

- **This diagram is for illustration purposes only it may not fully represent all or any of the frames you received. However the layout of the holes will be in the same pattern given the following exceptions**
- **Place a flange bolt in all 28 circled holes.**
- **Holes marked “A” (total of 5) may or may not be available in your model, if available use a flange bolt to secure them.**
- **Holes marked “B” could be in either the location where they are shown or the location where the dashed circle is shown. Place a flange bolt in all 6 holes according to the location provided in your design.**
- **Unmarked holes will not be used.**

If you cannot access the holes in the bottom (circled in the photo below) remove the wire way cover from the bottom left corner in the right frame.

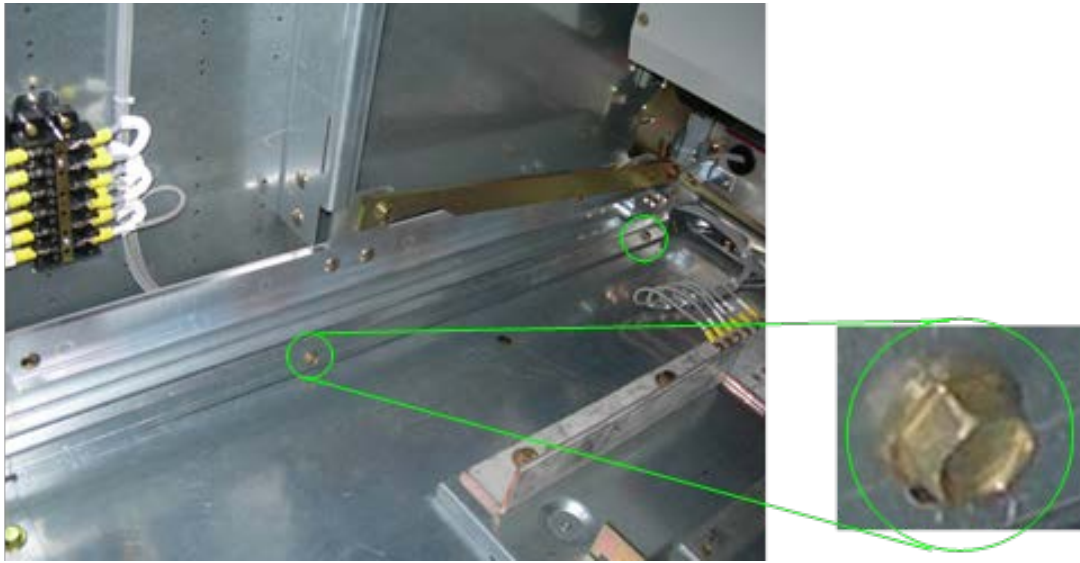

**Note: make sure to reinstall the wire way cover after securing the flange bolts.**

Open the bus doors in the back of the frame. Looking at the frames from the back the tinnerman nuts should be installed in the left frame.

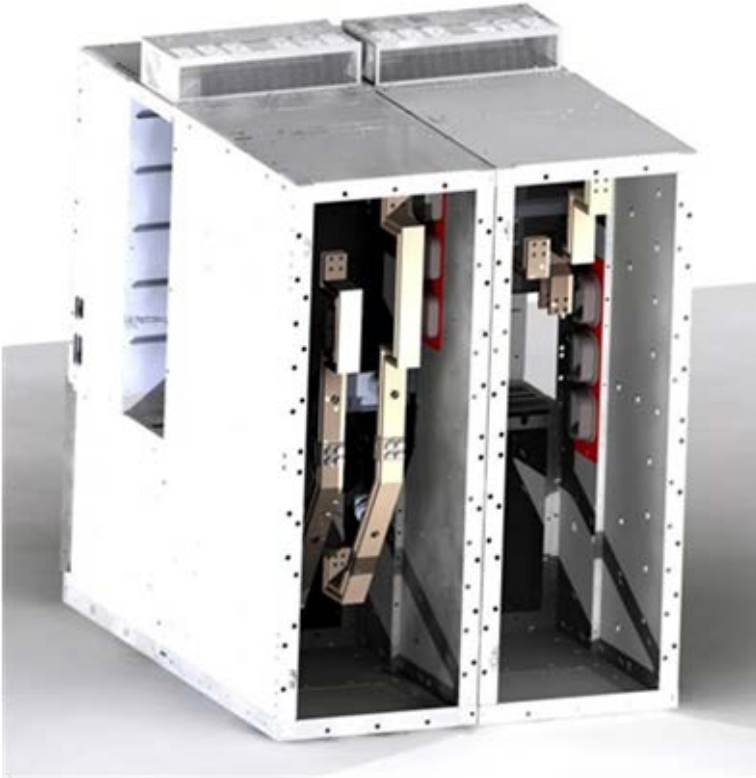

Insert a flange bolt in every hole in the right side that is aligned with a tinnerman nut in the left side. Use the following bolt layout to guide you on which holes to use.

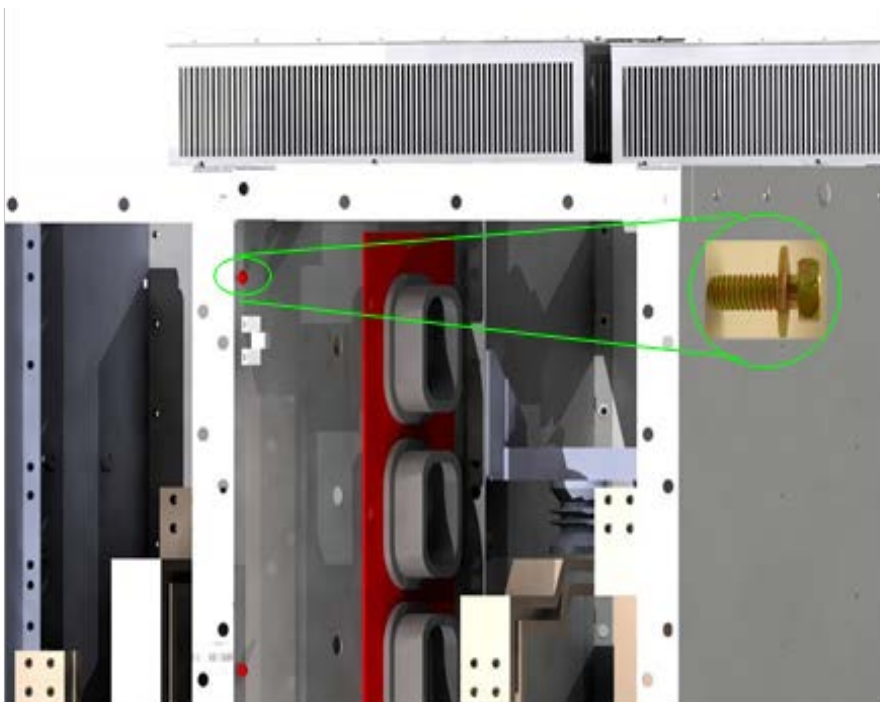



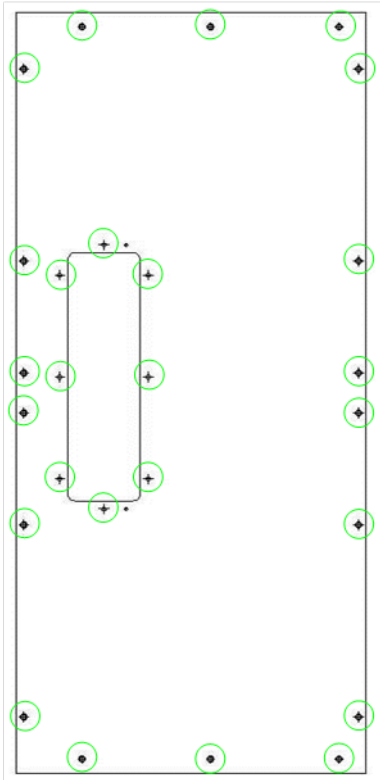

**Note: Place a flange bolt in all 26 circled holes**

Install the main bus at the shipping splits:

Open the bus doors in the back of the two frames where the main bus is to be installed and remove the upper and lower bus barriers in both frames.

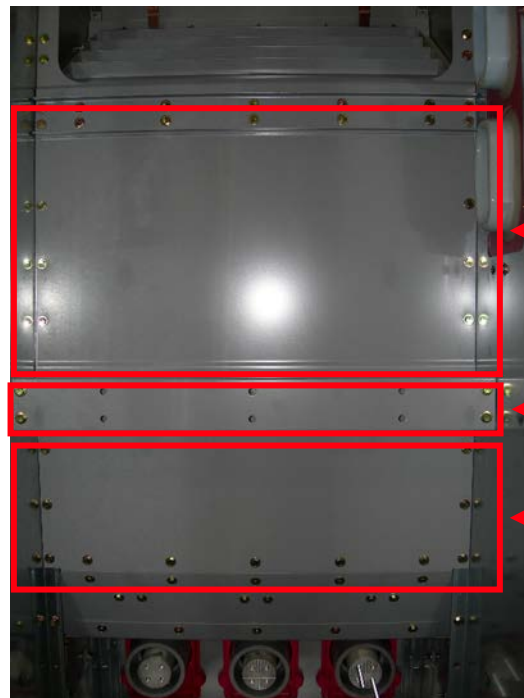
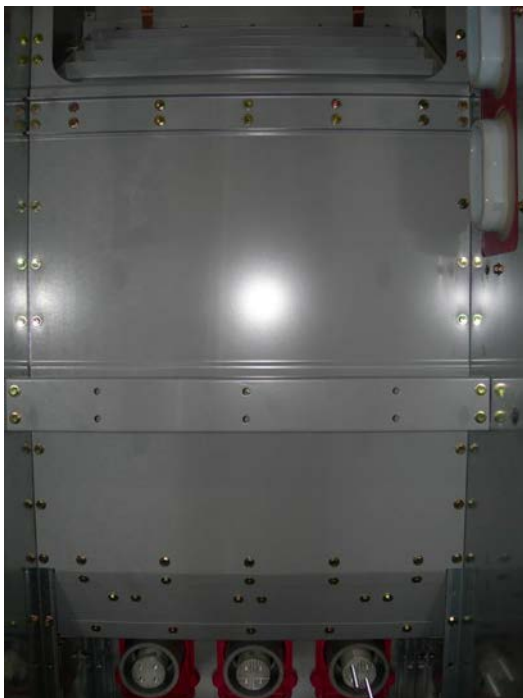

Top Barrier

Barrier support channel

Bottom Barrier

Start by removing the barrier support channel

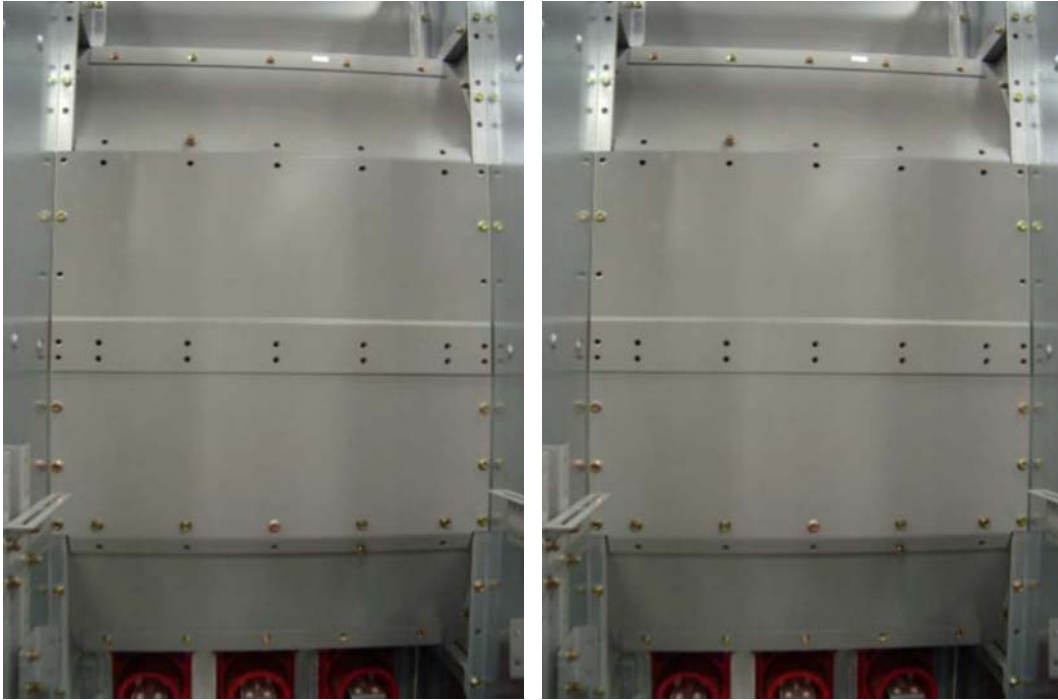

Remove the upper barrier.

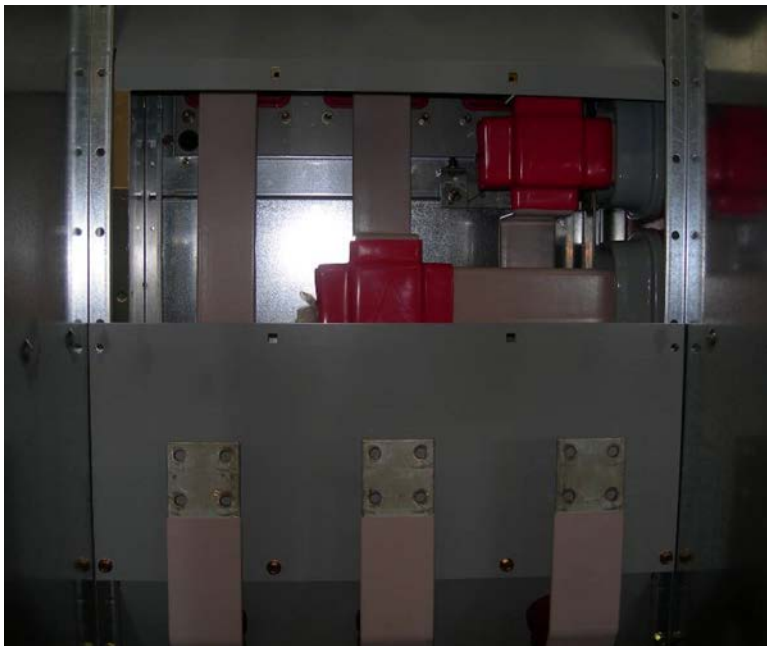

Then remove the lower barrier.



After removing the bus barrier remove all the bus boots. (The bus boots will be reinstalled after installation of the main bus).

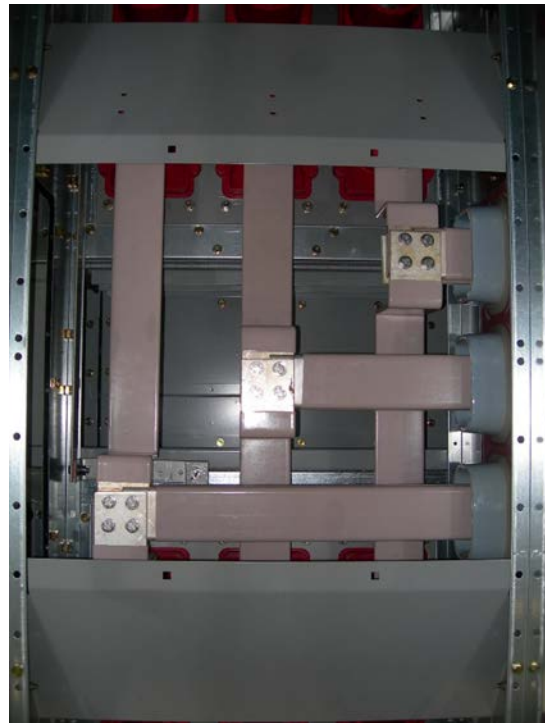
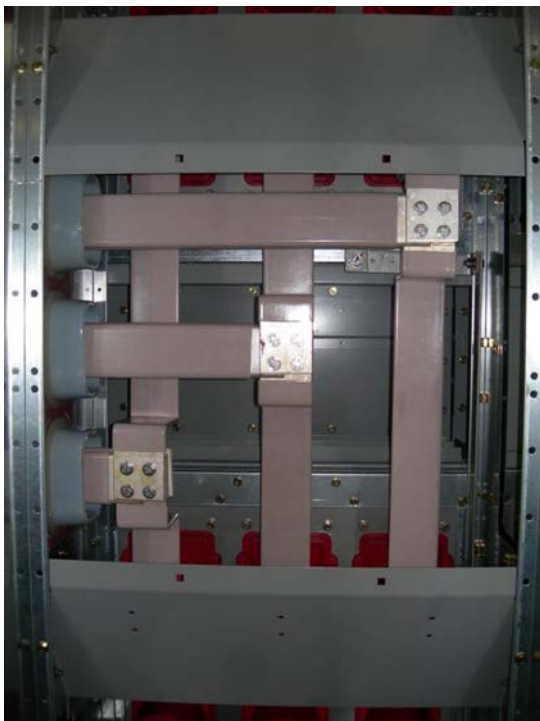

Slide the main bus bars through the three bus support bushings in the red rectangular sheet installed between the two frames.

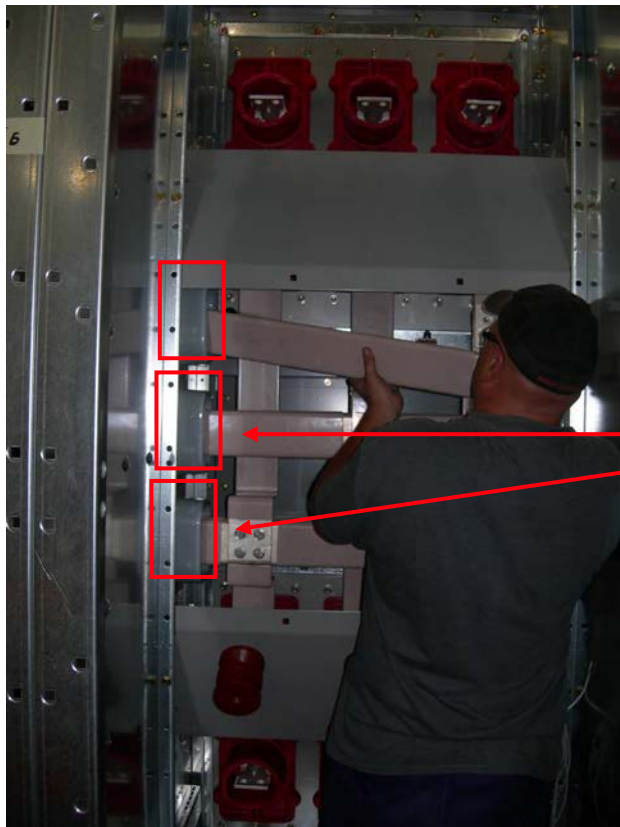
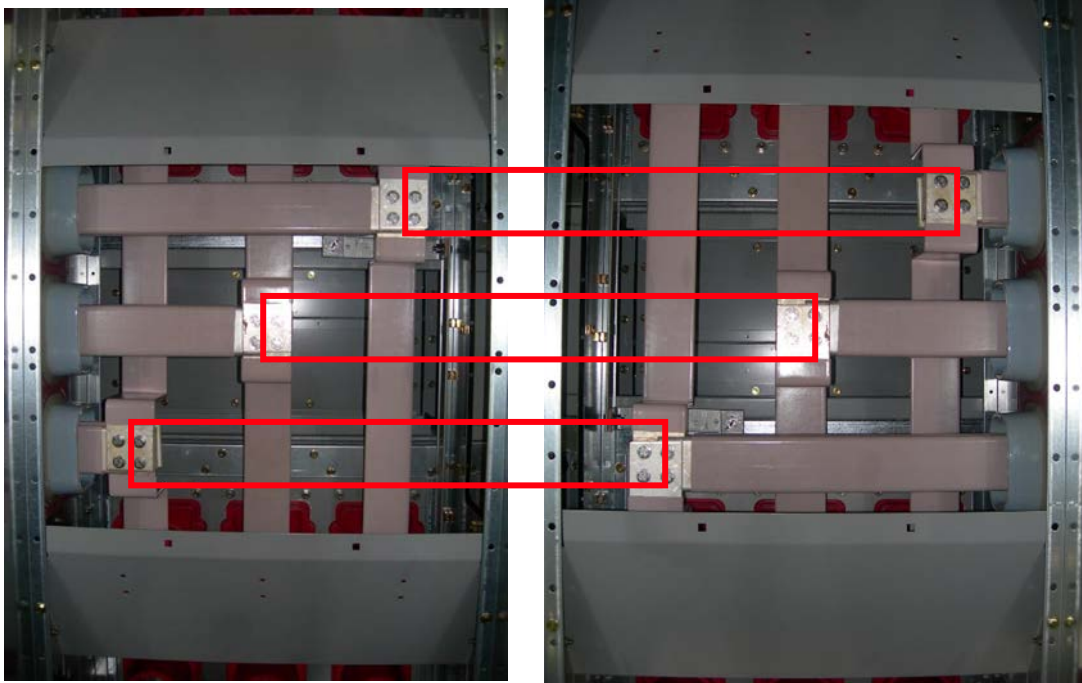

Slide bus bars through here

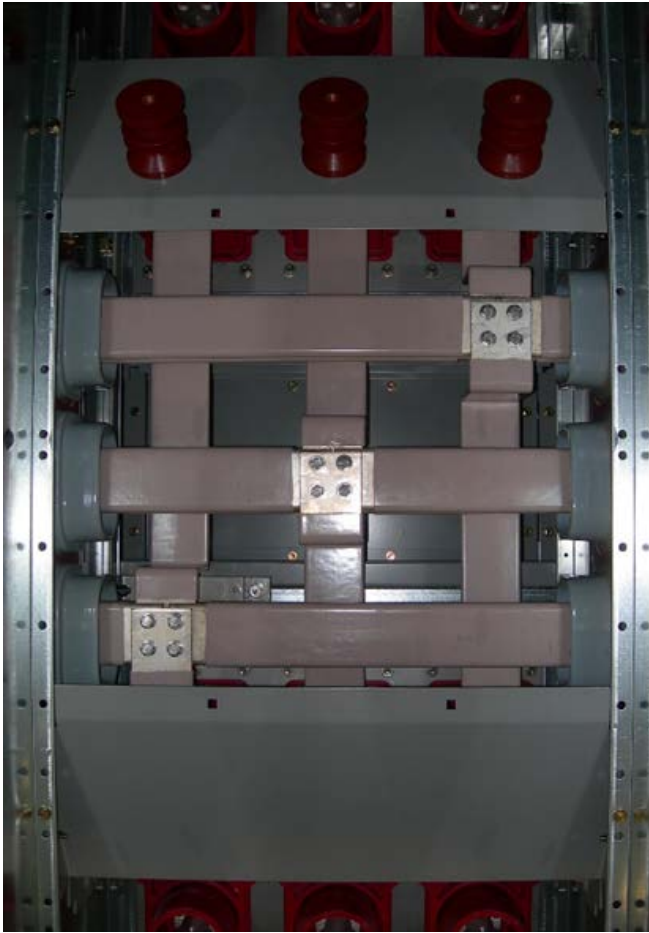

Place spacers where needed. Insert a bolt in all four holes to secure the bus bar. Do not tighten any of the bolts before you place all 24 bolts.

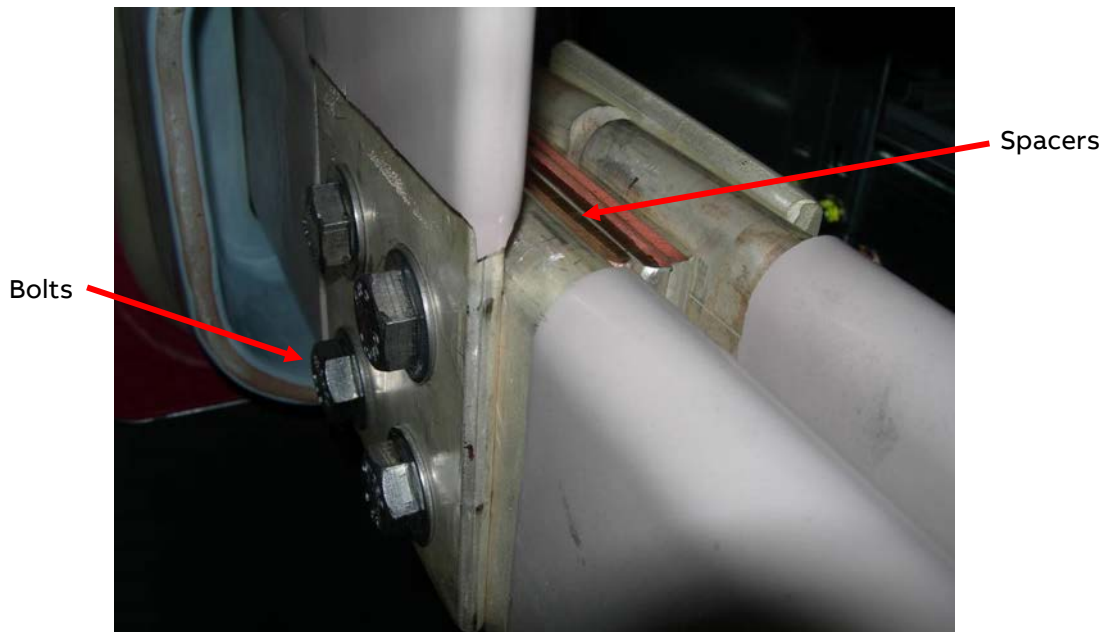

**Note:** This picture is for reference only it may not represent your actual setup. Please refer to the standard or special drawing provided to you by the project engineer for guidelines.

Use a torque wrench to tighten all the bolts to 55 lbs. Only tighten to 45 lbs if you are using stainless steel hardware and 35 lbs if using bronze hardware.

Reinstall the bus boots. (Refer to Bus Boot Installation section).



Apply the provided putty sealant around the inside rim of the bus support in the right frame (as shown below). Cut any excess putty.

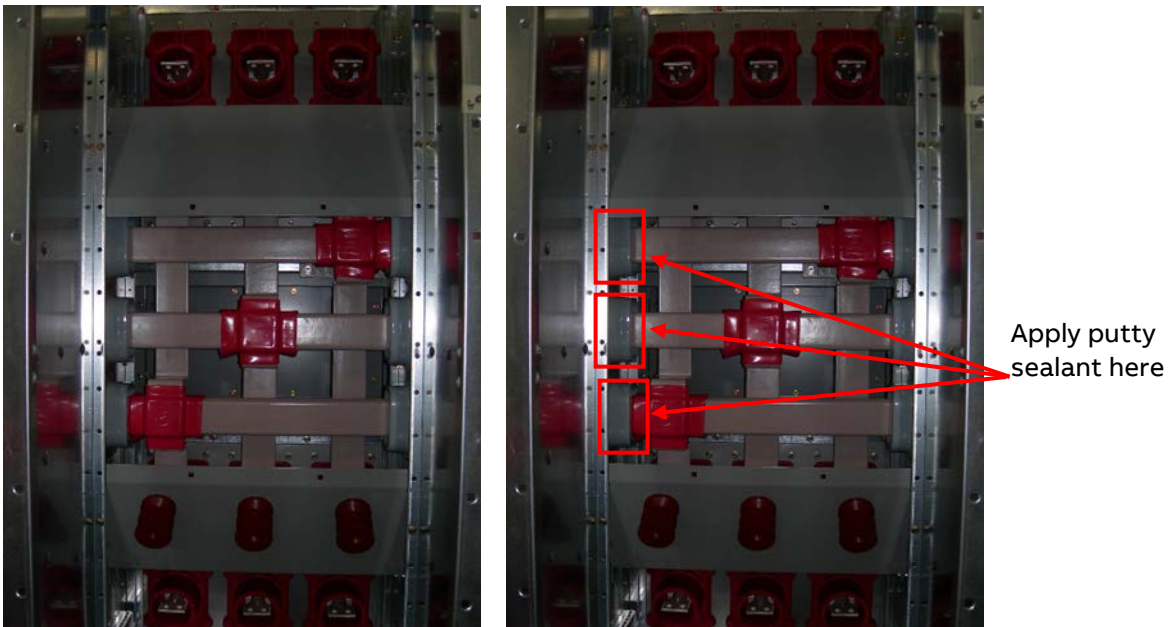

Left Frame

Right Frame

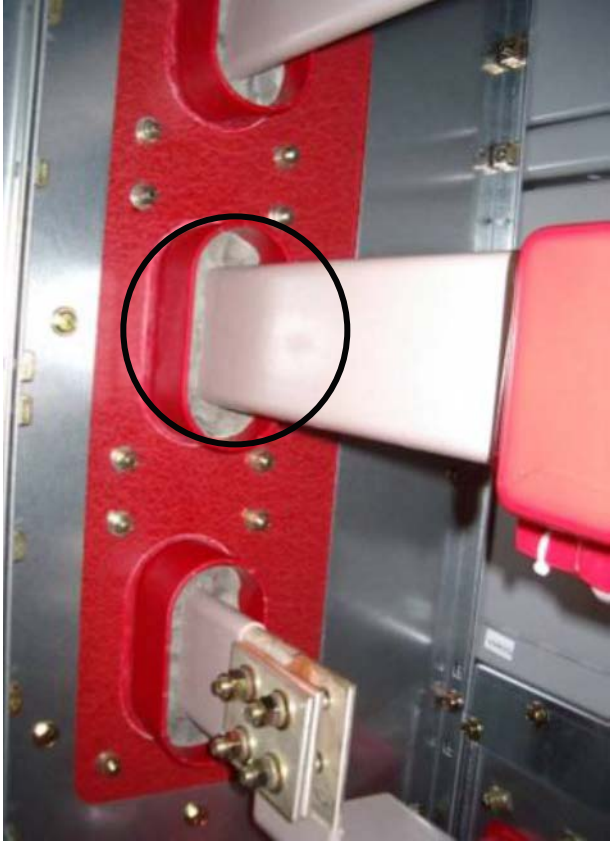

Putty sealant properly applied on all 3 phases

9- Reinstall the bus barriers, start by reinstalling the bottom barrier followed by the upper barrier and finally the barrier support channel.

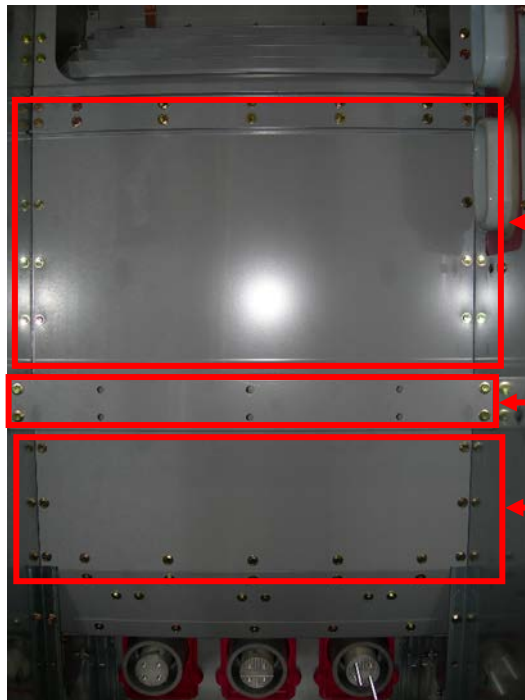
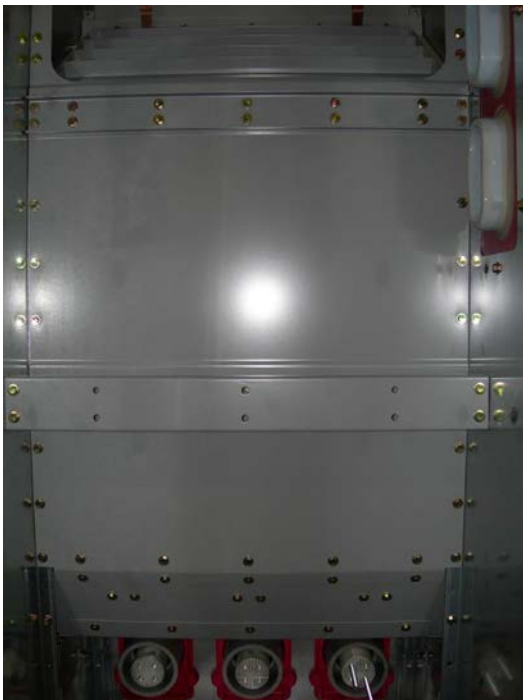

Top barrier

Barrier support channel

Bottom barrier

All bolted connections should be torqued to required levels as outlined in Appendix A.

Reconnect the control wiring at the shipping splits. Follow the connection diagram when replacing secondary and control wiring.

Complete all internal connections. Make the external connections to control power sources and circuits, to secondary and potential circuits, to feeders, power sources and to ground.

## CAUTION

**Ground bus connections should not penetrate any part of the switchgear not intended for cable of bus entrance. Not following this practice will affect the arc-resistant performance of the switchgear.**

## WARNING



**Power cable penetrations, top entry or bottom entry, into the equipment must be secured in the provided gland plates. It is recommended to use sealing glands/hubs for all cable penetrations.**



After completing all connections to secondary (control) circuits, follow these circuits and remove temporary connections from current transformer secondaries.

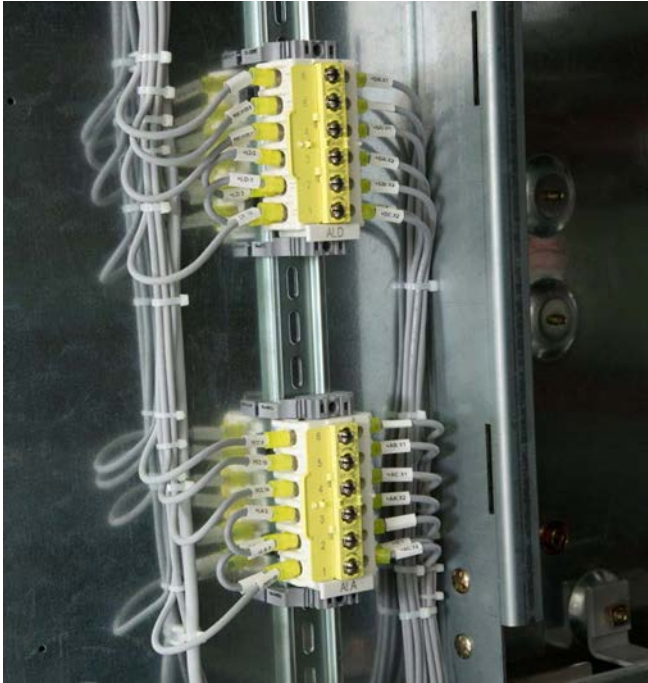

**CT Shorting Blocks**

Temporary jumpers protect against voltages that may occur if the current transformer primaries carry currents while the secondary circuits are still not complete. With the secondary circuits connected, remove the jumpers.

Note: Failure to remove the jumpers will interfere with meters, relays, or other devices in these circuits.

If shorting Terminal Blocks are used, review the Connection Diagram that was shipped with the unit, for position of shorting screws, see section 6.2.

## 5.5 Connection to Ground Bus

The factory bolts the ground bus bars to each frame. Connect the ground bus bars between the shipping splits and to the station ground with a cable or bus of equal or larger gauge than the housing ground bus.

Do not run cable or bus in conduit. The cable or bus should take the most direct path to ground.

## 5.6 Installation of the Plenum

The switchgear plenum is shipped separately in pre-assembled sections on pallets. Refer to the General Arrangement drawings for details on the layout of the plenum.

Remove all packing material and lift plenum sections to the top of the switchgear by suitable lifting means. Each section is then bolted to the plenum base mounted on the switchgear roof and also to the adjoining plenum section with provided hardware.

Once the roof-mounted plenums are in place install additional plenum sections, for venting outside the building, one at a time starting at the switchgear boundary.

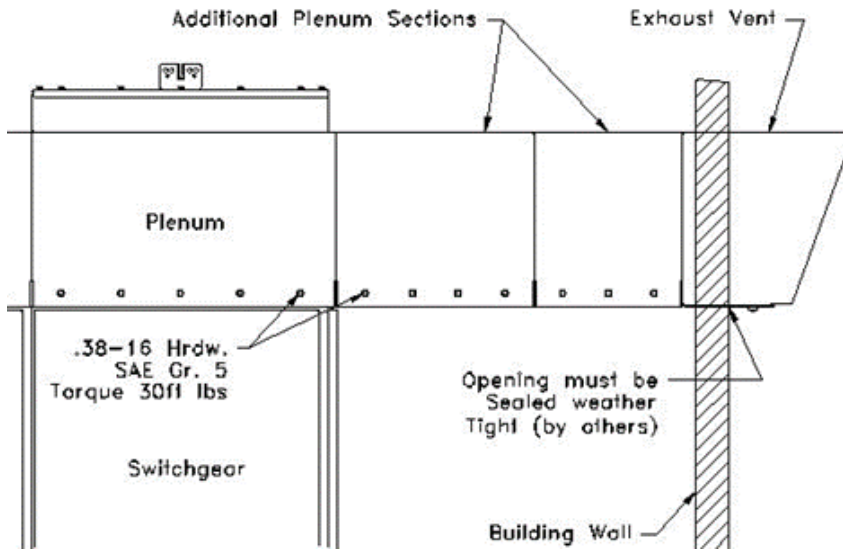

**Basic Plenum Installation**

As each section is installed provide permanent support for each section, either from above or below, starting with the first plenum section. The support should be able to brace the weight of each in accordance with local building code requirements.

Follow the specific plenum routing shown on the General Arrangement drawings.

The exhaust vent section should be installed in the building wall and connected to the last plenum section. Additional plenum information can be found in the Plenum Technical Guide, 1VAL104602-TG.

The area outside the plenum exhaust vent needs to be kept clear of personnel and equipment due to the potential for super- heated pressurized exhaust gasses being expelled in the area as a result of an arc fault in the switchgear. Specifically, a horizontal cylindrical volume, with an 8 foot diameter, centered on the plenum exhaust vent and extending out 15 feet, needs to be clear at all times.



**Plenum Exhaust Vent**

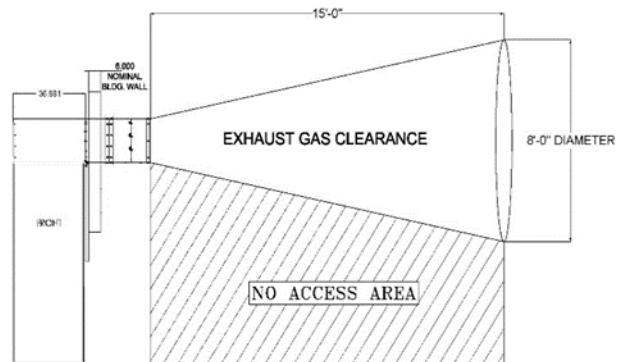

**Plenum exhaust "Keep Clear" area**

## 5.7 Secondary and Control Connections

The switchgear was wired in the factory in accordance with the Project specific Connection Diagrams. Refer to project specific drawings for locations of the incoming and outgoing wiring terminal blocks.

Openings in the side of the switchgear in the Low Voltage/Instrument compartment area allow control connections between sections. When shipped in groups of several units each, the factory installs interconnection wiring between groups. The factory then disconnects and tags one end of each of the connections, then pulls the wire bundle back across the split within the adjacent frame. Reconnect these interconnections according to the project specific connection diagrams after the equipment shipping sections are installed in place.

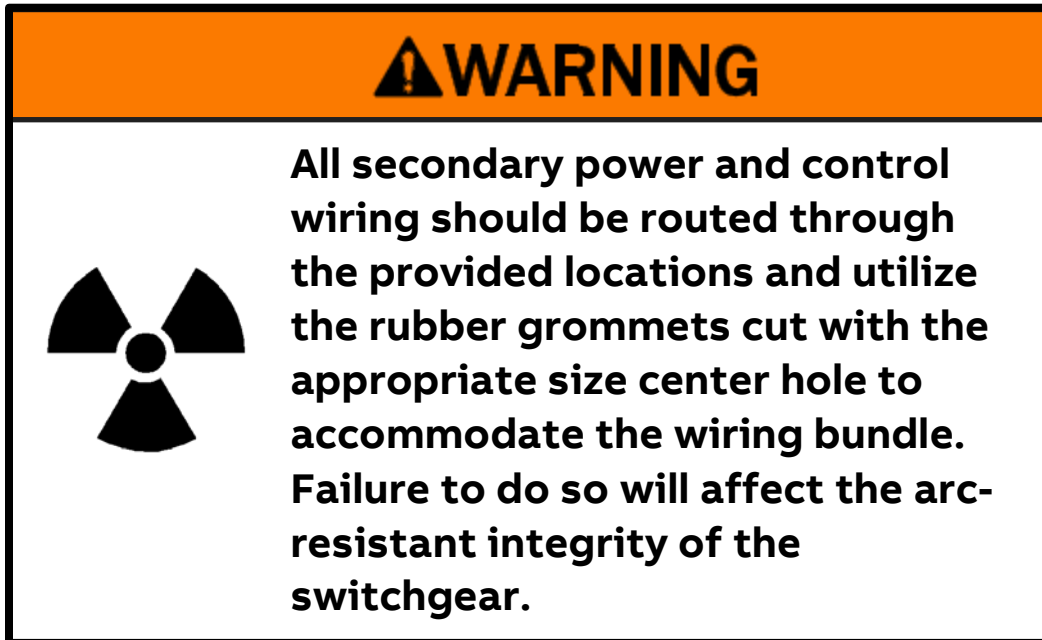

## 5.8 Primary Cable Connections

Area for connection of primary cables is provided in the cable compartment either through the roof or floor as indicated in the General Arrangement drawings. The gland plates are made of 1/8" stainless steel - these plates must be utilized in the final assembly. Holes for entrance of power cables or conduits must be cut in the gland plate(s) and a sealing type bushing is recommended.

### 5.8.1 Bus Boot Installation

Boot installation will need to be performed at the shipping splits (main bus connections) and at the cable connections.

In each location where a bus boot installation is required the bus boot and the nylon hardware will be attached to the bus as shown.



Only use Nylon Hardware to fasten the bus boot. DO NOT use steel hardware or Zip Ties. Make sure to use provided hardware to plug every hole on the bus boot.

1- At the shipping splits.

After connecting the bus

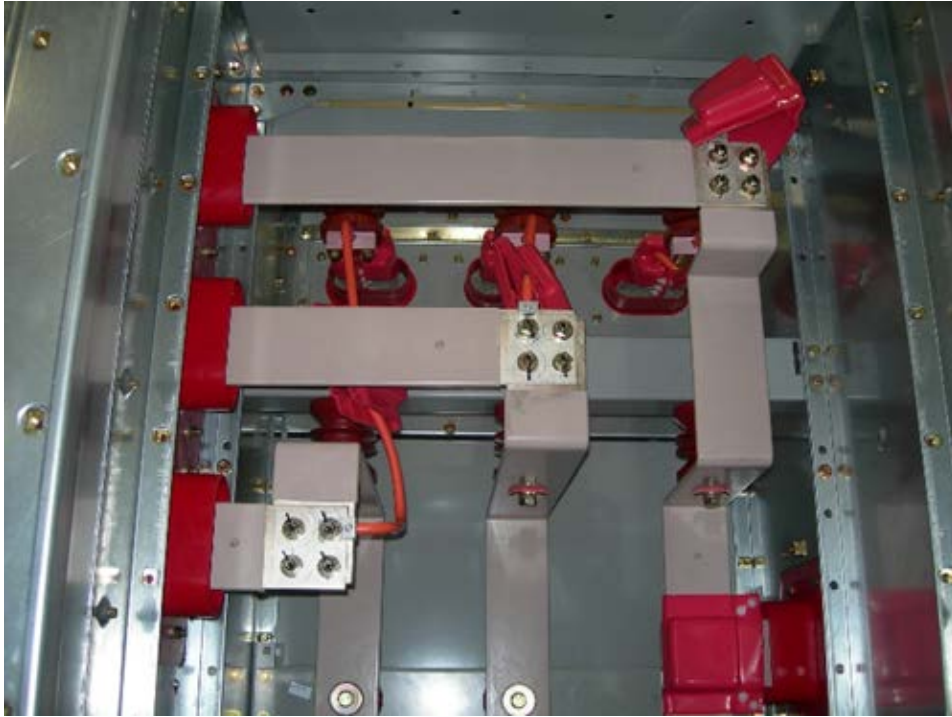

Place the rubber boot over the connection



Use the provided fasteners to plug every hole on the bus boot



At the cable connections:

For Single Conductor Connections

- Use a razor blade to cut an “X” shape on the back of the bus boot where the cable will enter.
- Slide the cable through the “X” and connect it to the bus.



- Slide the bus boot into the connection and use the nylon hardware to tighten.



#### For Multi-Conductor Connections

- Use a razor blade to cut circular holes on the back of the bus boot where the cables will enter (Do not cut more holes than needed)



- Slide the cables through the holes



- Tighten the cables to the bus.





- Slide the bus boot onto the connection and use the nylon hardware to tighten.



**To Install Nylon Hardware**

Place a bolt and a washer on one side of the bus boot and a washer and a nut on the other side of the bus boot as shown, then tighten all the screws.

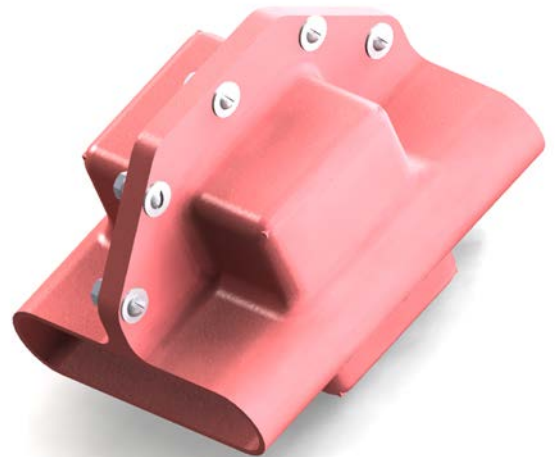
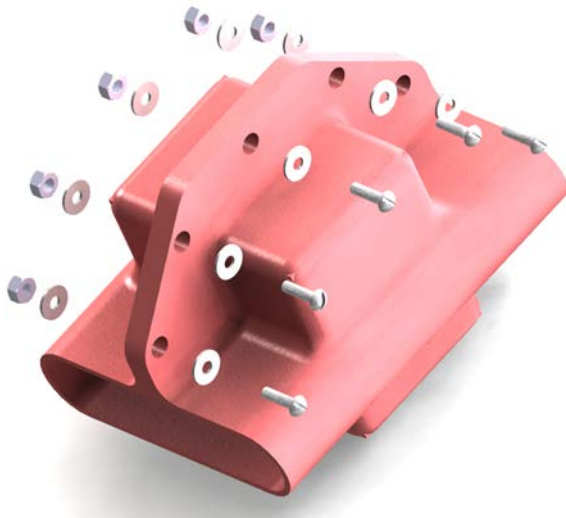

## 5.9 Connection to Control Source

The control source wiring should be properly sized to support the requirements of the control circuit. Connect the control source leads to the terminal blocks as indicated on the project Connection Diagrams.

**Note:** Check the electrical phasing before connecting.

## 5.10 Circuit Breaker: Insertion and Removal

Circuit breakers may ship separately. Remove the plywood crate/cover over the breaker that is securely attached to the pallet. Remove both clamp screws from the pallet.

**Note:** The factory installs blocks in the movable parts of breakers with under-voltage release. Reference the appropriate breaker instruction manual for specific instructions on this.



Breaker on the crated pallet



Clamp screws

All circuit breakers of like rating are interchangeable.

Circuit breakers have three positions in the housing.

1. The DISCONNECT position disengages the main disconnecting devices, and the control contacts on the breaker. They are a safe distance from the stationary part of the device located on the housings and the shutters are closed.
2. The TEST position disengages the main disconnecting devices, closes the shutters and engages the control contacts. This position allows operation of the circuit breaker for testing.
3. The CONNECTED position engages the main and control disconnecting devices on the breaker.

Mechanical interlocks prevent moving a circuit breaker from one position to another unless the circuit breaker is open. The interlocks also prevent closing of the breaker between positions.

### 5.10.1 Insertion

**⚠ CAUTION**

**Before inserting a breaker into a module, remove foreign objects, tools and debris, or obstructions from inside the module.**

Open the breaker cell door completely

With the lift truck platform at ground level and the foot brake engaged. Push the interlock release handles on the breaker inward and roll the breaker onto the lift truck. Roll completely onto the platform until the locking tabs engage the locking slot.

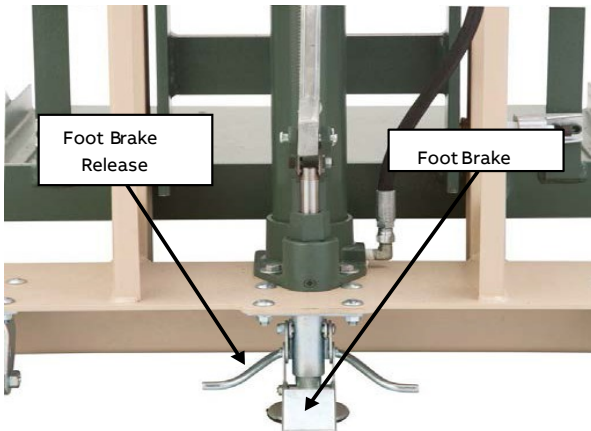

Lift truck foot brake

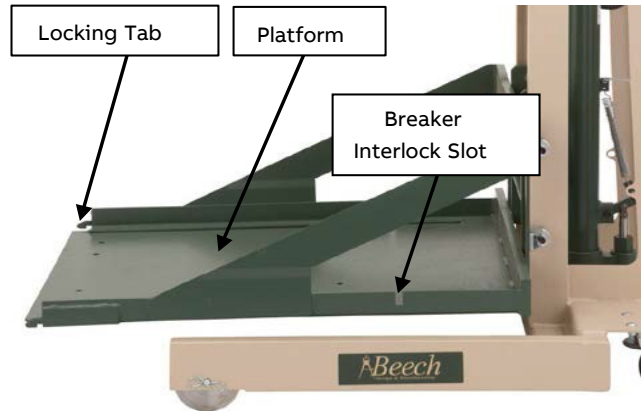

Lift truck platform

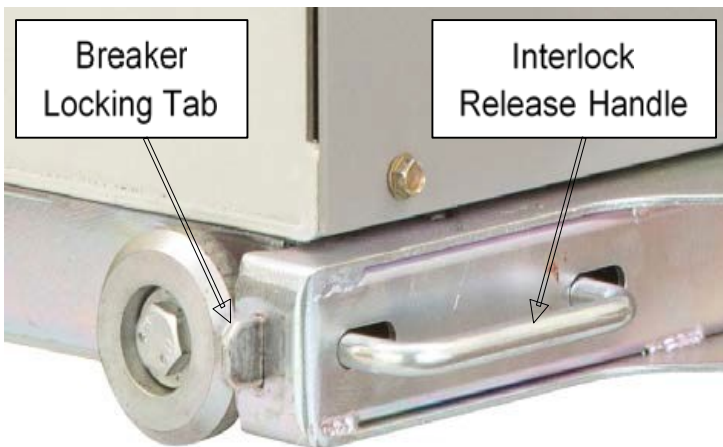

Breaker Truck Interlock, tabs and handles

Raise the lift truck platform by pumping the foot pedal. Release the foot brake and push the lift truck towards the breaker cell.



**Lift truck foot pedal**



**Lift truck with breaker**

For panel screw and turn handle doors, align the locking tabs of the lift-truck with the lift truck tab slots in the front of the frame. Adjust the lift-truck to the frame to engage the locking tabs with the slots. Adjust the truck platform either by moving up using lift truck foot pedal or lowering the platform with the lift truck control valve to lock locking tabs with the lift truck holding pin. The truck platform should be horizontal and aligned with the rails in the module. Try pulling the lift truck away from the frame. The locking tabs should be set firmly in place. Set the foot brake.

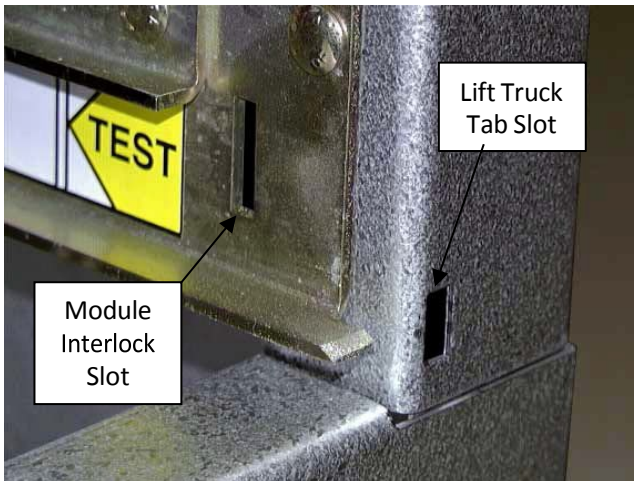

**Module interlock slots (left hand shown)**



**Lift truck control valve**

For multipoint latch (MPL) doors, align slots on lift truck with the locating pin in the breaker compartment floor. Adjust the lift-truck to the frame to engage the locking pins with the slots. Adjust the truck platform either by moving up using lift truck foot pedal or lowering the platform with the lift truck control valve to lock locking pins. The truck platform should be horizontal and aligned with the rails to ensure proper engagement. Try pulling the lift truck away from the frame. The locking pins should be set firmly in place. Set the foot brake.

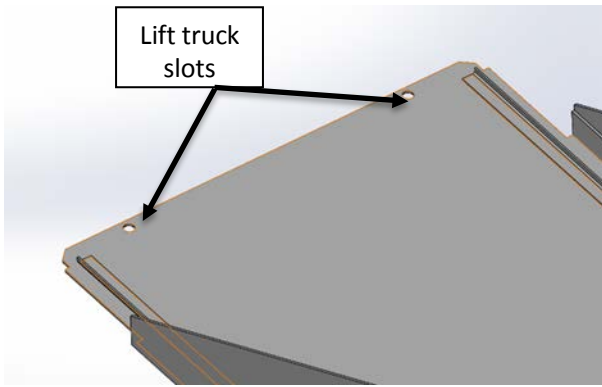

**Lift truck plate for MPL doors**

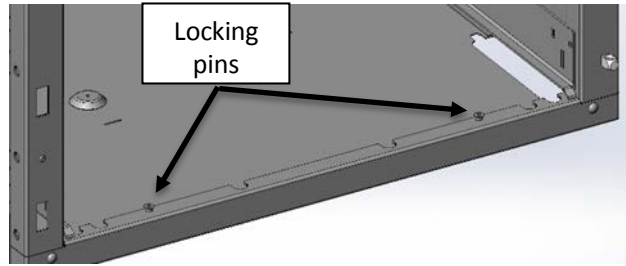

**Compartment locking pins for MPL doors**

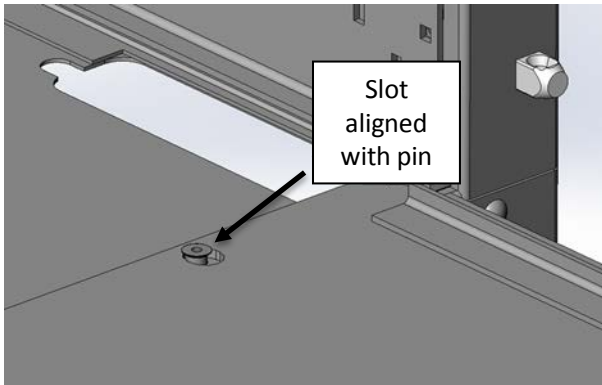

**Lift truck plate engaged with breaker compartment**

Release the circuit breaker from the lift truck by pulling both module interlock release handles toward the center of the unit simultaneously.

Push the drawout unit straight into the module. Keep the unit level as possible. Do not raise or lift the circuit breaker.

Align the breaker locking tabs with the module interlock slots.

Engage the breaker locking tabs by returning the handles to their outward position.

Verify that the handles are fully outward and the breaker locking tabs have engaged fully into the module interlock slots.

**Note:** The unit will not rack into the TEST position if the Breaker Locking Tabs are not properly engaged with the Module Interlock slot on the frame.

**⚠ WARNING**



**Always assure that the module interlock tabs are fully extended and locked into place with the module interlock slot to avoid injury and damage from a loose breaker falling from the frame.**

Disengage the lift-truck by raising the platform via the foot pedal, release the foot brake, and move it away from the frame. The circuit breaker is now in the DISCONNECTED position.



**Circuit breaker in DISCONNECT position**

Close the breaker compartment door and secure the latching mechanism by pushing the door handle against the door. Ensure the door is fully seated and latched. If door is bolted design, torque all bolts to 16ft-lbs. Over-torquing of these bolts will result in damage to the door assembly and will compromise the arc-resistant integrity of the equipment.

To rack from the DISCONNECTED position to the TEST Position:

## **⚠ CAUTION**

**Always rack the breaker through the door socket while the door is closed.**

Press down on the racking release handle on the breaker compartment door.

## **⚠ CAUTION**

**Only use hands to actuate the racking release handle as excessive force can damage the mechanism.**



**Racking release handle**

Engage the racking screw on the breaker with the racking tool and rotate clockwise (CW).

Release the handle and continue to rack the unit by rotating the racking tool clockwise until the racking screw stops, approximately 4 turns. The breaker is now in the TEST position.

Verification can be made by confirming the position indicator on the right side breaker rail shows TEST.

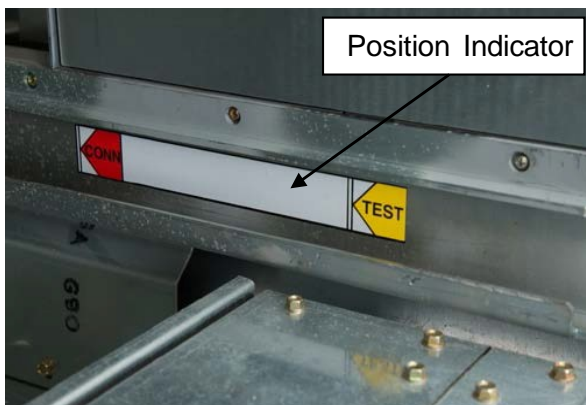

**breaker position indicator**



**Circuit breaker in TEST position**

**Circuit**

To rack from the TEST position to the CONNECTED position:

Press down on the Racking Release Handle on the breaker compartment door.

Engage the racking screw with the Racking Tool and rotate clockwise (CW) approximately 21 turns.

Release the handle and continue to rack the unit by rotating the racking tool clockwise. A slight increase in resistance indicates that the unit is engaging the primary contacts. When the racking screw stops, the breaker is now in the CONNECTED position.

Verification can be made by confirming the position indicator on the right side breaker rail shows CONNECTED.



Circuit breaker in CONNECTED position

### 5.10.2 Removal

To rack from the CONNECT position to the TEST position:

**Do not open the breaker compartment door.** The breaker must be OPEN before proceeding to the next step.

Press down on the racking release handle.

Engage the racking screw with the racking tool and rotate counterclockwise (CCW). Release the handle and continue to rotate counterclockwise, from the CONNECTED position into the TEST position.

To rack from the TEST position to the DISCONNECTED position:

Press down on the racking release handle.

Engage the racking screw with the racking tool and rotate counterclockwise (CCW). Release the handle and continue rotating counterclockwise, from the TEST position into the DISCONNECTED position.

Removal from the DISCONNECTED position with a lift truck.

Open the breaker compartment door.

For panel screw and turn handle doors, align the locking tabs of the lift truck with the lift truck holding pin in the front of the frame. Push the lift truck to the frame to engage the locking tabs with the compartment. Lower the truck platform slightly to lock in place. The truck platform should be horizontal and aligned with the rails in the compartment. Set the lift truck foot brake. Try pulling the lift truck away from the frame. The locking tabs should be set firmly in place and the brake set.

For multipoint latch doors, align slots on lift truck with locating pin in the breaker compartment floor. Adjust the lift-truck to the frame to engage the locking pins with the slots. Lift truck platform should fit between breaker truck and breaker compartment floor. Adjust the truck platform by moving up using lift truck foot pedal or lowering the platform with the lift truck control valve to lock locking pins. The truck platform should be horizontal and aligned with the rails in the module. Try pulling the lift truck away from the frame. The locking pins should be set firmly in place. The locking pins should be set firmly in place and the brake set. Set the foot brake.

Release the circuit breaker from the compartment by pulling the interlock release handles toward the center of the unit.

Pull the drawout unit straight onto the lift truck platform. Keep the unit level as possible.



Align the breaker interlock tabs with the lift truck slots. Engage the breaker interlock tabs by returning the handles to their outward position.

Verify that the handles are fully outward and the breaker interlock tabs are in the lift truck slots.

Raise the lift truck platform to disengage the lift truck holding pin, release the foot brake and pull the lift truck away from the frame.

Close and latch/bolt the circuit breaker compartment door.



### 5.11 Auxiliary Modules

Drawout compartments are provided for Potential Transformers, Control Power Transformers and Fuses units for remote Control Power Transformers.



Insertion, racking and removal of Auxiliary Drawout elements is similar to racking a circuit breaker. The units do not have a TEST position and there is not a racking release handle on the compartment door.

#### **CPT/Fuse Auxiliary Modules**

In the DISCONNECTED position, the interlock key(s) are removed from the CPT fuse unit interlock located at the top of the compartment. This prevents the racking of the CPT/Fuse unit from DISCONNECTED to the CONNECTED position. The key should be stored remotely to prevent accidental switching between the "ON" or "OFF" position or inserted into the secondary breaker Kirk lock located inside the low voltage compartment. Kirk lock plunger normally extends out when the key is removed.

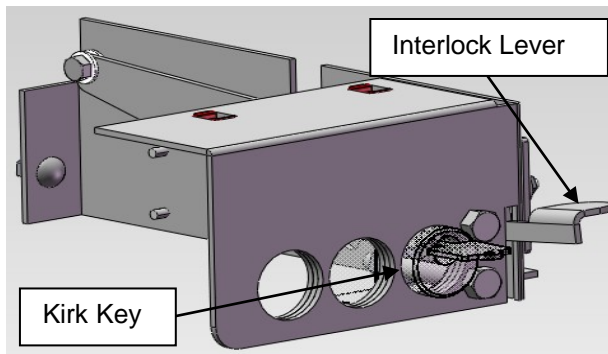

CPT Fuse blocking mechanism.

### 5.11.1 Insertion

To rack the CPT/Fuse unit from the DISCONNECTED to the CONNECTED position:

Verify the secondary breaker, located in the low voltage compartment is in the “OFF” position and the interlock key from secondary breaker Kirk lock is removed. This will prevent the breaker from switching to “ON” position.

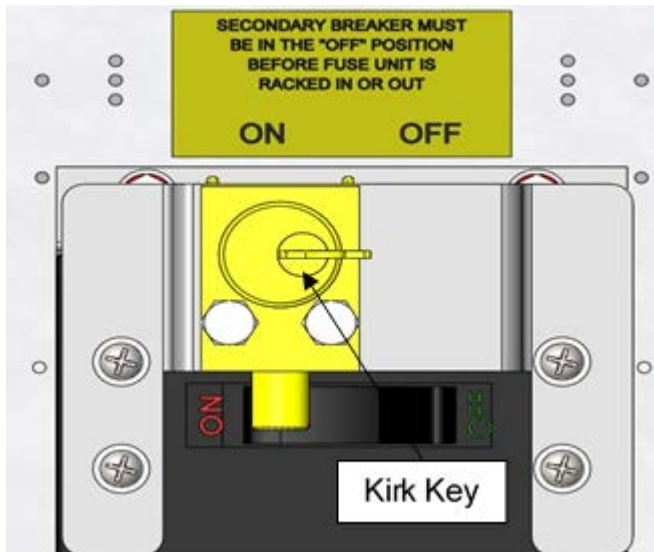

Secondary breaker interlock

Open the CPT/Fuse unit door.

Insert the key to the CPT/Fuse unit Kirk lock and turn the key to retract the Kirk lock plunger and now the spring will retract the blocking mechanism.

Close and securely latch/bolt the CPT fuse unit door.

Engage the racking screw with the racking tool and rotate clockwise (CW), until the racking screw stops and the unit is in the CONNECTED position, approximately 25 turns.

After confirming that the CPT is in CONNECTED position via the position indicator on the right side truck rail, open the latched door of CPT/Fuse unit.

Press down the CPT fuse unit interlock lever and remove the key from CPT fuse unit Kirk lock. The key can be removed only when the Kirk lock plunger is completely engaged with the interlock mechanism.

Close and securely latch/bolt the CPT fuse unit door.

Insert the key into the secondary breaker Kirk lock. Turning the key enables retraction of the interlock plunger. Now, the secondary breaker can be switched to the “ON” position.

### 5.11.2 Removal

To rack from the CONNECTED to the DISCONNECTED position:

Switch the secondary breaker to the “OFF” position. Remove the interlock key from secondary breaker Kirk lock, which causes the Kirk lock plunger to extend out. The secondary breaker is now in “OFF” position and the interlock plunger prevents it from switching to “ON” position

Open the CPT/Fuse unit door.

Insert the key to the CPT/Fuse unit Kirk lock and turn the key to retract the Kirk lock plunger and now the spring will retract the blocking mechanism.

Close and securely latch/bolt the CPT fuse unit door.

Engage the racking screw with the racking tool and rotate counter-clockwise (CCW), until the racking screw stops and the unit is in the DISCONNECTED position, approximately 25 turns.

After confirming that the CPT/Fuse unit is in DISCONNECTED position via the position indicator on the right side truck rail, open the CPT/Fuse unit door.

Press down the CPT/Fuse unit interlock lever and remove the key from CPT/Fuse unit Kirk lock. The key can be removed only when the Kirk lock plunger is completely engaged with the interlock mechanism.

The CPT/Fuse device can now be removed from the compartment via the lift truck.

Close and securely latch/bolt the CPT fuse unit door.

### 5.12 Setting the 2000A and 3000A Vent Flaps

Set the Module Inlet Ventilation Flaps in the open or operating position by pushing the lever on the lower front flange of the breaker compartment inwards. Push the lever in until the ventilation flaps lock into open position. The damper on the rear of the vent structure should lock into place in the open position as a result.

Set rear door ventilation flaps in the open or operating position by pushing the lever in the center of the vent opening inwards. Push the lever in until the ventilation flaps lock into open position.

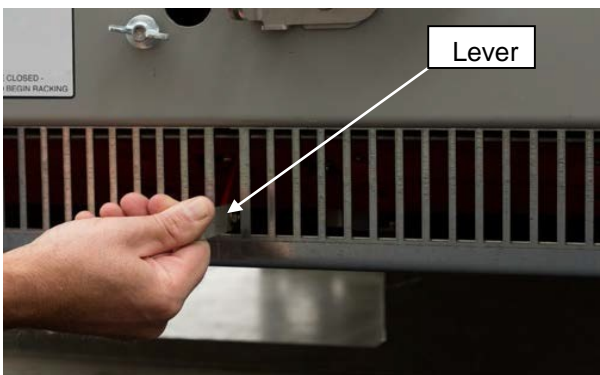

Module Inlet Ventilation Flaps in open position

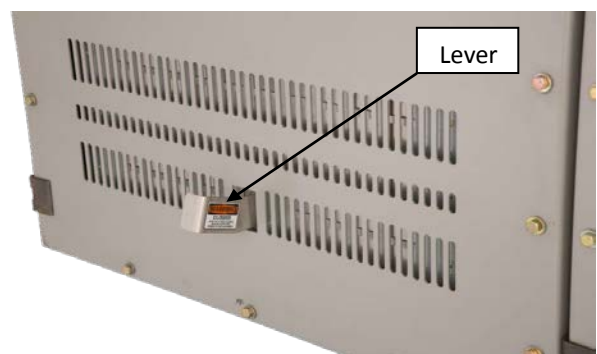

Rear door ventilation flap in closed position

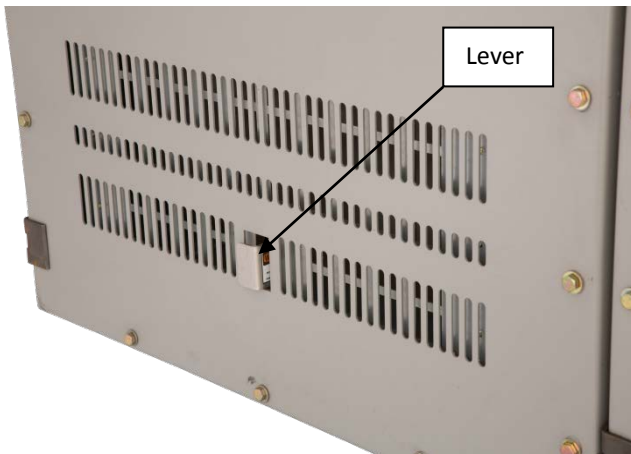

Rear door ventilation flap in open position

Set plenum ventilation flaps in the open or operating position by pushing the lever on the top of the vent structure on the plenum downwards. Push the lever down until the ventilation flaps lock into open position. A 10 foot step ladder should be used to access the roof mounted plenum. Be sure to follow all site safety procedures for accessing elevated positions and ladder use.

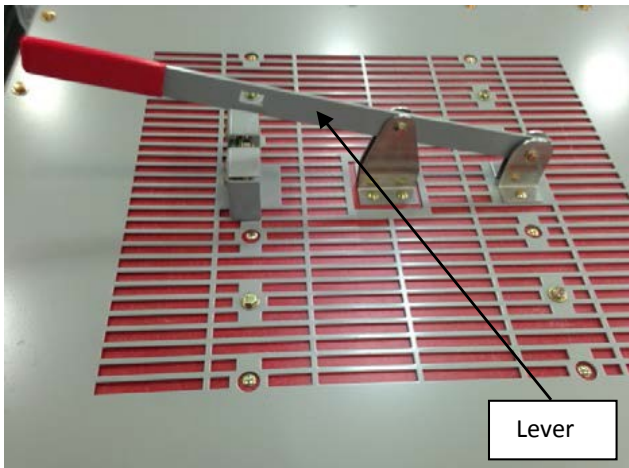

Plenum ventilation flap in closed position

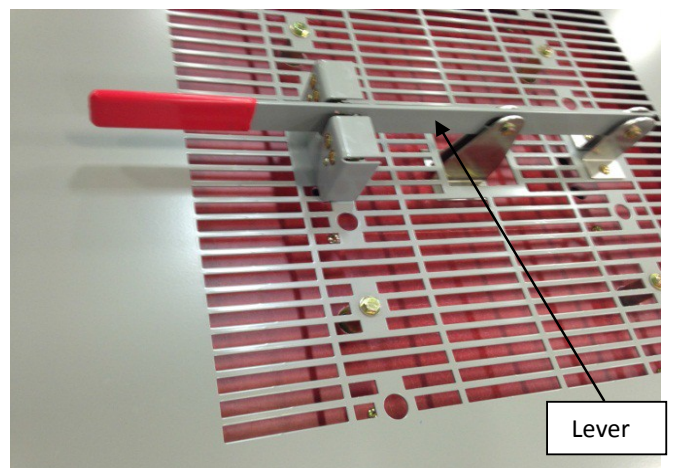

Plenum ventilation flap in open position

**⚠ WARNING**



**All ventilation flaps must be opened before putting the equipment into service. Failure to do so will result in overheating and equipment damage.**

### Defeating Front Door Interlock (MPL optional feature)

To defeat the front door interlock (front doors are not allowed to be opened with breaker in test or connected positions), for those projects so equipped, in case of emergency only, unscrew the handle mounting screws and remove the interlock pin.

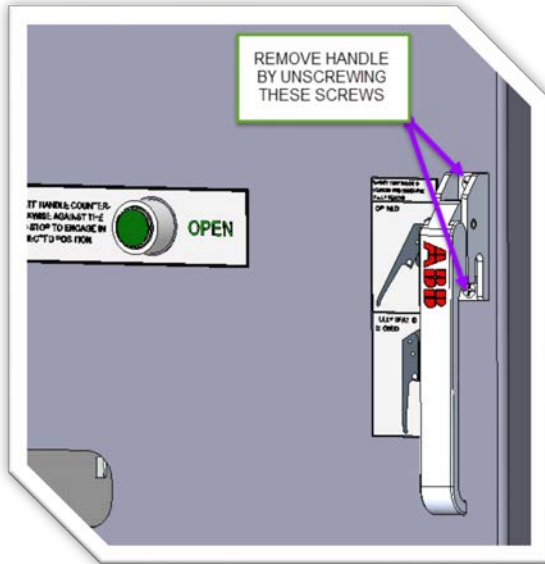

Remove Door Handle

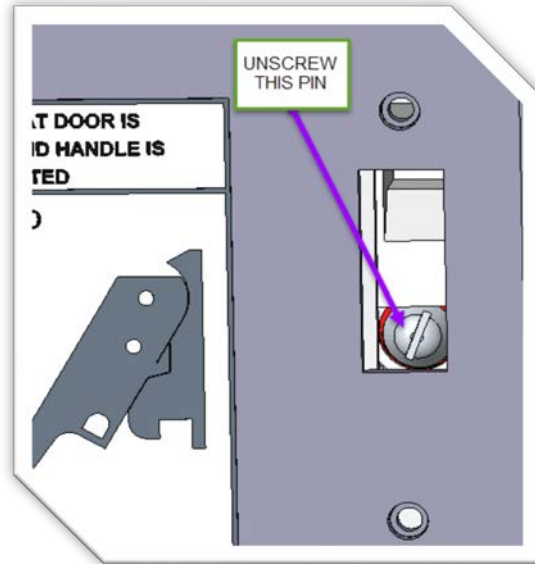

Remove Interlock Pin

Once the interlock screw is removed, use a screwdriver to move the latching bar up to unlatch and open the door.

At this point the breaker can be opened and the door closed and latched allowing the breaker to be racked from the connected position as detailed in Section 5.11.2.

### 5.13 Adjusting the front door (MPL Doors only)

There is a door adjustment block installed on the left side of the compartment and located at top hinge mounting place. The adjuster has two screws for adjustment to prevent sagging and misalignment. Access to adjusting screws possible only when door is open. To make door adjustments follow the procedure below:

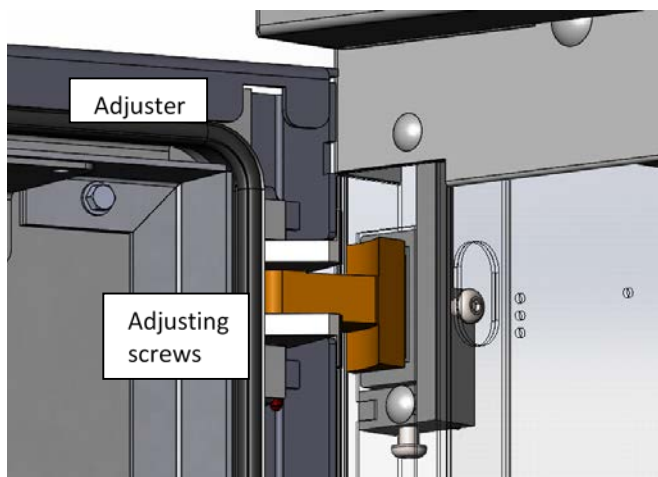

Adjusting block with screws

Remove hinge side wire way cover to access adjustor block.

Slightly loosen all five hinges.

Adjust the door by turning adjusting screws. The bottom screw adjusts for misalignment (vertically) and the side screw adjusts sagging.

Re-tighten all five hinges.

## 5.14 Mounting Rear Doors

### 5.14.1 Bolted/Hinged Doors w/inner panels

Install rear inner and external panels. Inner panels should be installed with the weld nuts at the top of the upper panel and bottom of the lower panel. Do not tighten hardware until all bolts have been inserted. Exterior panels should be installed by inserting hardware in the upper holes first to hold the panel in place. The remainder of the hardware should be inserted before tightening.



Installation of upper inner rear panel



Installation of lower inner rear panel



Installation of upper exterior rear panel



Installation of lower exterior rear panel

Frames with single, full-height hinged panels should be done in the same order with inner panels being installed first, then the hardware on the exterior panel installed and then tightened.

Doors with bolts should be closed and all bolts tightened to a torque of 15 ft-lbs. Failure to tighten all bolts to the recommended torque will compromise the arc resistant integrity of the switchgear assembly. Overtightening of the bolts can result in damage to the door seal and will compromise the arc resistant integrity of the switchgear assembly.

### 5.14.2 Bolted/Hinged Doors w/o inner panels

Install door via lifting provisions. Lifting provisions for eye-bolt lifting provided on the door. Doors should be installed by inserting hardware in the upper holes first to hold the door in place. The remainder of the hardware must be inserted before tightening.

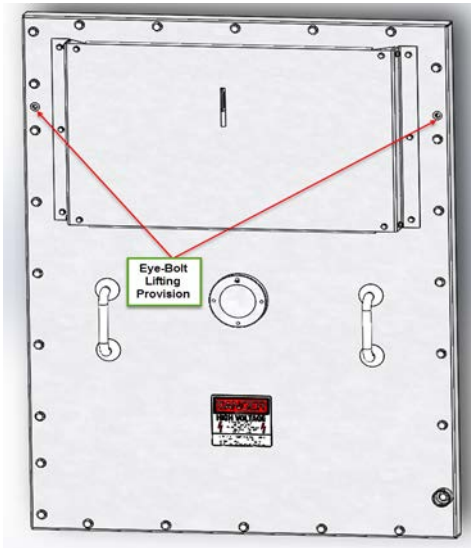

Lifting provisions for doors w/o inner panel

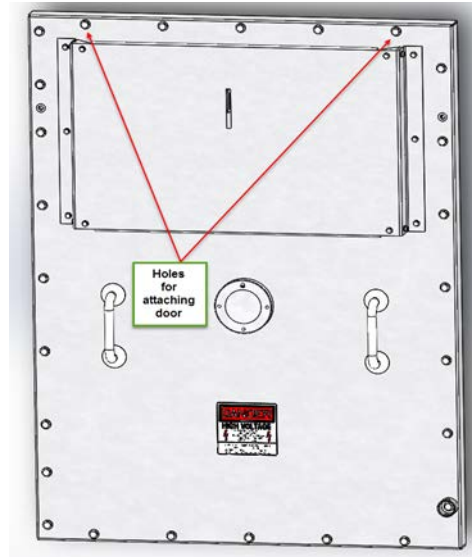

Holes to be used for attaching doors

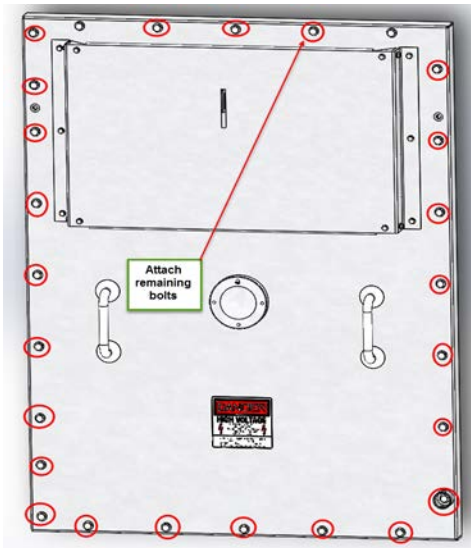

Remainder of the hardware

Doors with bolts should be closed and all bolts tightened to 15 ft-lbs. Failure to tighten all bolts will compromise the arc resistant integrity of the door assembly. Overtightening of the bolts can result in damage to the door seal and will compromise the arc resistant integrity of the door assembly.

## 6. TESTING AND FINAL INSPECTION

### 6.1 Testing

**⚠ DANGER**

**Disconnect the primary power source**  
**Do not exceed the listed voltages for the voltage class of the equipment under test**  
**Disconnect the shunt connected coils such as potential transformers**  
**Do not test sensors or relays with high voltage**  
**Disconnect all sensors and relays before applying voltage**

With the system erected, assembled and connected, perform the following 16 step process.

Remove all packing and shipping materials.

Make sure that all internal parts are clean and dry. If moisture is present, blow dry with warm air.

Remove any shipping blocks from relays.

Check for damaged insulation by applying potential tests to the primary bus. Conduct potential tests phase-to-phase and phase to ground in accordance with “Field Test” values as shown in Table 1.

**Table 1**

<b>60 HZ, RMS, WITHSTAND VOLTAGES (1 minute)</b>			
Rated	Factory Test	Field Test	DC Field Test*
up to 250 volts	1500	1125	none
4160 volts	19,000	14,250	20,000
7200 volts	36,000	27,000	38,000
13,800 volts	36,000	27,000	38,000

\* The column headed “DC Field Test” is a reference for those using dc tests to verify the integrity of connected switchgear. It represents values believed to be appropriate and approximately equivalent to the corresponding power frequency withstand test values specified for each voltage class of switchgear. The presence of this column in no way implies any requirements for a DC withstand test on AC equipment. Also, it does not imply that a DC withstand test is an acceptable alternative to ANSI C37.20 for design, production, or conformance tests. When making DC tests, raise the voltage to the test value in discrete steps and hold for one (1) minute.

With the main circuit de-energized and grounded, check the continuity of all circuits after installing the circuit breakers. Energize the control source and operate the equipment. Indicating instruments verify the continuity of current transformer circuits and energizing of the main circuit.



## 6.2 Control Circuit Checkout

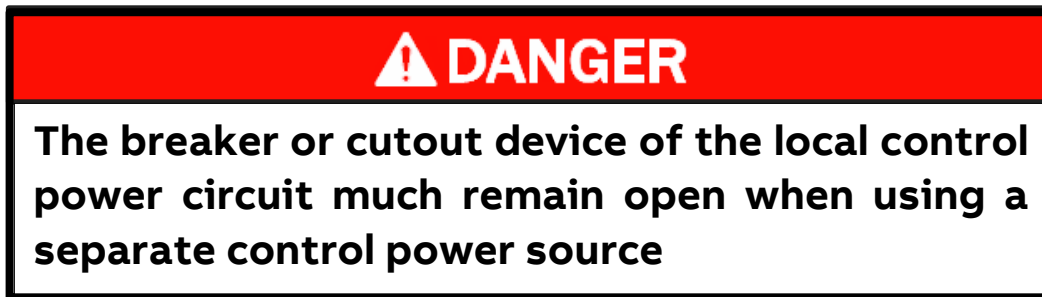

The preferred method to check the control circuit is to furnish a separate temporary source of control power of the required control voltage rating. The temporary source must have a properly coordinated backup protective device in the circuit. Set the device to clear any faults that might occur. Initially all circuit breakers should be in the DISCONNECT position and the main circuit de-energized and grounded. When AC control power is supplied from control power transformers in the switchgear, remove all fuses in the transformer circuits.

Rack all circuit breakers to the DISCONNECT position.

Open all normal control power source disconnects, if supplied.

Check each control switch or push-button. Make sure that it is in the OPEN position.

Connect a temporary control power source to the circuit load terminals in the switchgear. Energize the control circuit from the temporary control power source. Refer to the project specific electrical drawings for connections.

Rack one circuit breaker into the TEST position. When the on-off switch is in the ON position, the charging of the closing springs of an electrically operated circuit breaker indicates connection to the control power.

Rack the remaining circuit breakers into the TEST position, one at a time and verify that each is connected to control power.

Test all electrically and manually operated breakers for closing and tripping, while they are in the TEST position. Use the optional test set available with the trip unit for testing solid state tripping.

De-energize the control circuit. If AC control power is from transformers in the switchgear, remove the temporary separate source of control power. Reinstall all fuses in the transformer circuit.

Set all relays, regulators, and other devices for proper operation of loads. The factory does not set the relays.

Disconnect all shorting screws from the terminal blocks in the current transformer circuits.

**Note: Verify the proper phasing of all main circuits according to connection diagram.**

To open the short circuiting device, loosen all shorting screws (CCW) until each one has extended up to the level of the yellow label strip as shown below. Do not loosen the ground screw.



Upon completion of testing, return all shorting screws to the shorted position by pushing the screw inward and turning until tight (CW).

### 6.3 Final Inspection

**⚠ DANGER**

**There are hazards of electrical shocks and/or burns whenever working in or around electrical equipment. Turn off power ahead of the switchgear before performing any inspection or maintenance operations. Check incoming line terminals to verify that the equipment is de-energized and grounded. Check out-going terminals to ensure that no back-feed condition exists.**

Once installed and all connections made, perform a final check and test on the equipment and its controls. Check for correct equipment installation and that all connections are complete. Use extreme care to prevent the controlled equipment from being connected to the system while performing preliminary tests.

## 7. PLACING SWITCHGEAR INTO SERVICE – SAFETY PRECAUTIONS

**⚠ DANGER**

**There are hazards of electrical shocks and/or burns whenever working in or around electrical equipment. Turn off power ahead of the switchgear before performing any inspection or maintenance operations. Check incoming line terminals to verify that the equipment is de-energized and grounded. Check out-going terminals to ensure that no back-feed condition exists.**

The circuit breakers should be in the TEST position.

When working on switchgear, de-energize and ground the main-bus.

Before energizing any part of the switchgear make a complete check of the mechanical operation of all devices. Remove blocking wedges from relays, circuit breakers, meters, etc. Manually operate all circuit breakers and relays. Moving parts should not bind. Verify that there are no foreign objects in the equipment. Use compressed, clean, dry air to clean all inside and outside surfaces.

Make incoming and outgoing power connections after all other connections are complete. A note on the connection diagram indicates devices that are phase sensitive. Verify the phase sequence of the incoming power source before making connections.

**Note: The secondary circuits of energized current transformers should never be open circuited.**

The contact surfaces of the bus at bolted joints are plated. Clean contact surfaces with a clean cloth and an OSHA approved solvent. Bolt the bus together. Conductivity of a bolted joint depends on the pressure or torque applied.

### 7.1 Energizing the Main Bus

After completing the control circuit checkout, energize the equipment main bus.

Verify that all door and panel hardware is secure.

Energize the incoming bus to the main circuit breaker of the equipment. Observe if operation of instruments and relays are correct.

Energize the separate control power source, if furnished.

Energize the switchgear main bus by closing the main circuit breaker. Observe if operation of instruments and relays are correct.

Rack the circuit breakers to the CONNECTED position.

Close the desired feeder and tie-breaker circuit breakers.

## 8. STANDARD CONSTRUCTION

### 8.1 Standard Color

The standard paint color is ANSI #61. This finish is electro-static powder paint applied over an iron phosphate coating. This process achieves a smooth, uniform paint finish that conforms to all UL requirements.

### 8.2 Galvanized Steel Frame Construction

Unpainted parts are made of galvanized steel. Galvanized steel greatly exceeds the paint qualifications of ANSI C37.20.2 Section 5.2.8.

### 8.3 Bus Support Insulation

The bus supports are indoor epoxy type. The supports ensure safe operational clearances of bus under normal and abnormal (short circuit) conditions. No maintenance is required if the short-circuits do not cause any visual damage.

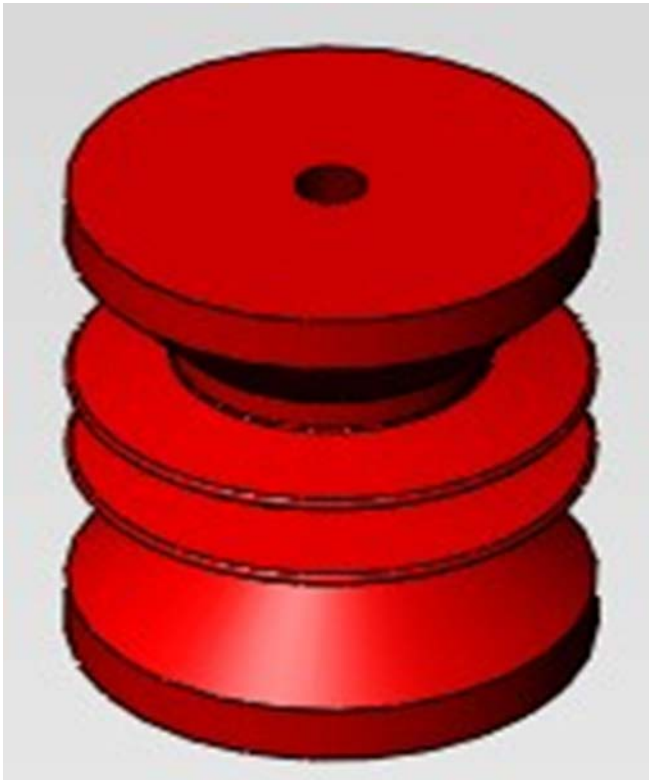

Bus Support

### 8.4 Primary Disconnect Assemblies

Circuit breaker primary disconnects consist primarily of a circle of fingers compressed by a garter spring. The springs are outside the current path. The fingers can be inspected by withdrawing the unit. The primary contacts are high pressure, self-aligning devices. All parts are plated to reduce electrical resistance.

### 8.5 Secondary Disconnecting Devices

Circuit breakers have self-aligning disconnects sized for the required current. They make contact in the CONNECTED and TEST positions, without the need for a test jumper.

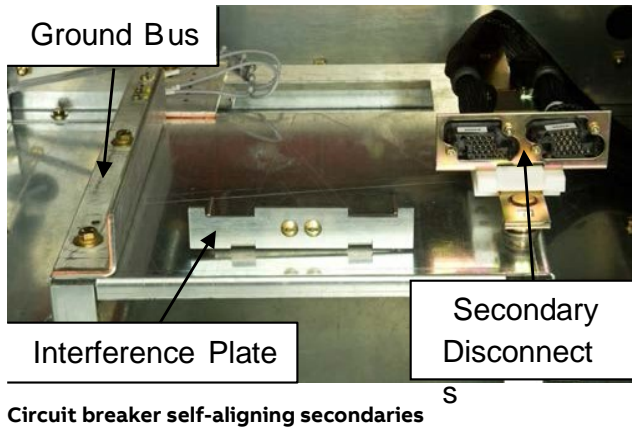

Circuit breaker self-aligning secondaries

## 8.6 Ground Bus Contacts

The ground bus contacts are under the circuit breakers. The circuit breakers are grounded in all positions.

## 8.7 Control Wires

ABB standard control wiring is insulated type SIS, made of flexible stranded conductors, unless otherwise specified by contract specifications.

## 9. MAINTENANCE

### 9.1 General

Inspect all switchgear installations at frequent intervals. Perform a visual inspection, front and rear, to see that there is no evidence of loose parts, warping, or undue vibration. Take steps to remedy any deficiencies of this nature that may appear. Keep the assembly dry. Cover to prevent moisture from dripping on equipment. Verify that all flaps and vents are open and are not blocked.

**⚠ DANGER**

**There are hazards of electrical shocks and/or burns whenever working in or around electrical equipment. Turn off power ahead of the switchgear before performing any inspection or maintenance operations. Check incoming line terminals to verify that the equipment is de-energized and grounded. Check out-going terminals to ensure that no back-feed condition exists.**

### 9.2 Annual Inspection

Perform the following recommended inspection and maintenance once a year, or sooner, if required by local conditions or regulations.

Perform an overall visual inspection.

Check all indicators, meters and instruments for proper operation.

Make sure all bolted connections are secure. All bolted joints must be torqued per ABB specifications – see Appendix A. Bolted connections should be tight. Discoloration, excessive corrosion, embrittled or discolored insulation may indicate an overheated connection. If found, follow the procedure described under section 9.5 “Bolted Joint Maintenance.”

Verify operation of heaters and thermostats, if used.

Check for undue noise and vibration that might loosen bolted connections.

Look for evidence of moisture in the switchgear. Evidence of moisture can be but not limited to water droplets, condensation, oxidized metal, etc.

Inspect all cables for tight connections and ample support.

Inspect control wiring for signs of wear and damage, especially at door hinge locations. Replace wire wherever doubtful.

Examine resistors and other devices prone to overheating.

Open all hinged doors and inspect hinges and latches.

Clean insulation thoroughly.

Withdraw and clean all drawout components. Refer to Circuit Breaker Installation Operation and Maintenance Manual 1VAL050502-MB before cleaning contacts.

**⚠ CAUTION**

**Limit the use of solvents to removing grease and contamination from primary conductors, insulation and from unpainted metallic surfaces. Do not use alcohols or freons. Use OSHA approved solvents in accordance with local regulations. Use a non-flammable solvent with a threshold limit of 300 PPM or higher. Use solvents in well-ventilated areas.**

Clean the stationary portion of the switchgear by wiping with a clean cloth. Use dry, compressed air in inaccessible areas.

Remove the covers of all panel devices where possible. Check wiring for secure connections. Clean contacts on relays and switches wherever necessary. Replace covers.

Remove air filters when used. Flush with clean water if necessary. Coat filters with Randolph Products', Super Coat Adhesive or equivalent.

Inspect the chains/sprocket and the lifting rail of lift truck, if used for normal operation. For normal operation use a heavy gear lubricant. In very dirty or gritty conditions, use a dry lubricant.



**Lift Truck chain and sprocket**

Follow the recommendations of any individual device instructions furnished for maintenance of the device. Contact ABB Service if any abnormality is experienced.



### 9.3 24 Month (Two Year) Inspection

In addition to the annual inspection, perform the following recommended inspection and maintenance at 24 month (two year) intervals, or sooner, if required by local conditions or regulations.

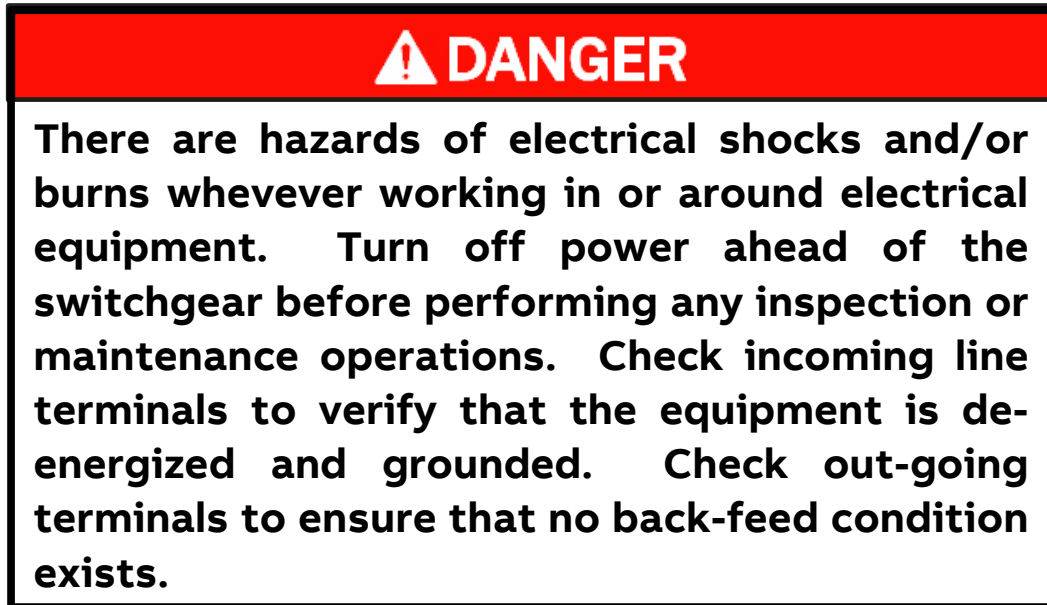

Clean the circuit breaker stationary primary contacts. Refer to Circuit Breaker Installation Operation and Maintenance Manual 1VAL050502-MB for detailed instructions.

Inspect secondary wiring bundles for signs of discoloration because of heat or chafing. Check for cracked or embrittled insulation. Replace wire whenever unsure.

Inspect primary insulation system for accumulated contamination. Clean insulation with a dry cloth, dry-air, vacuum, or if necessary with an OSHA approved solvent.

Check the calibration of protective relays.

Follow the recommendations of any individual device instructions furnished for maintenance of the device.

Contact ABB Service if any abnormality is experienced.

### 9.4 10 Year Maximum Inspection

In addition to the annual inspections and maintenance, perform the following recommended inspections and maintenance every ten years, or sooner, if required by local conditions or regulations.

1. Disassemble, inspect, clean, lubricate, adjust and calibrate circuit breaker mechanisms as recommended in the instructions furnished with the circuit breaker.
2. Torque all primary conductor connection bolts to recommended values. All bolted joints must be torqued per ABB specifications – see Appendix A.
3. Tighten all secondary control wire connections. Check for loose lug crimps and broken wire strands.
4. Contact ABB Service if any abnormality is experienced.

## 9.5 Bolted Joint Maintenance

**⚠ DANGER**

**There are hazards of electrical shocks and/or burns whenever working in or around electrical equipment. Turn off power ahead of the switchgear before performing any inspection or maintenance operations. Check incoming line terminals to verify that the equipment is de-energized and grounded. Check out-going terminals to ensure that no back-feed condition exists.**

Tighten all secondary control wire connections. Check for loose lug crimps and broken wire strands.

Open bus joints and inspect connection surfaces.

Clean surfaces with an OSHA approved solvent. Dress contact surfaces that show minor corrosion or pitting by lightly rubbing with a polishing cloth such as “3M Scotch Brite”. Take care to minimize the removal of plating.

Replace parts that show signs of heavy corrosion, arcing or melting.

Replace contact fingers and springs after exposure to excess heating at the breaker disconnect.

Before assembly, protect contact surfaces with No-Ox-ID ‘Special A Compound’, a product of Sanchem Chemical Co., ABB Part No. 713222A00, or equivalent.

Use proper torque in tightening bolted connections. All bolted joints must be torqued per ABB specifications – see Appendix A.

## 9.6 Care of Finish

The paint and galvanized finish is strong and durable. Always keep the switchgear clean. Wiping with a clean dry cloth will usually suffice. To remove oil and grease marks, use warm water and soap, and wipe dry with a clean, dry, soft cloth.

Because the color and finish may vary, consult the front sheet of the Bill of Materials before using touch-up paint. The standard paint color is ANSI 61, light gray.

## 9.7 Renewal Parts

Previous experience and the number of vertical sections in service are the best guidelines for determining the stocking of replacement parts. Order factory original replacement parts from ABB Inc., Lake Mary, Florida 32746. Specify quantity, part numbers, description, and nameplate data of the device requiring the replacement parts.

**For replacement parts, call toll free: 1-800- 929-SWGR.**

**Outside of USA call: 1-407-732-2000**

## 9.8 End of life of Product

ABB products are manufactured to meet or exceed the standards of compliance for quality and environmental management systems in accordance with ISO 9001 and ISO 14001. All of these items can be supplied with a certificate of quality.

### Methods of Disposal

Disposal can be carried out in a manner of ways depending upon material of product. Below is the recommended method of disposal for various raw materials.

The duty of ABB is to facilitate subsequent recycling or disposal at the end of product life. During disposal of the product, it is always necessary to act in accordance with local legal requirements in force.

RAW MATERIAL	RECOMMENDED METHOD OF DISPOSAL
Metal material (Fe, Cu, Al, Ag, Zn, W, etc.)	Separation and recycling
Thermoplasts	Recycling or disposal
Epoxy resin	Separation of metal and disposal of remains
Rubber	Disposal
Oil (transformer oil)	Draining and recycling or proper disposal
SF6 gas	Discharging from equipment
Packing material	Recycling or disposal

## 9.9 Disclaimer of Warranties and Limitation of Liability

### DISCLAIMER OF WARRANTIES AND LIMITATION OF LIABILITY

There are no understandings, agreements, representations of warranties, expressed or implied, including warranties of merchantability or fitness for a particular purpose, other than those specifically set out by an existing contract between the parties. Any such contract states the entire obligation of the seller. The contents of this document shall not become part of or modify any prior or existing agreement, commitment or relationship. The information, recommendations, descriptions and safety notations in this document are based on ABB experience and judgment with respect to metal-clad and metal-enclosed switchgear. This information should not be considered to be all inclusive or covering all contingencies.

No warranties, expressed or implied, including warranties of fitness for a particular purpose or merchantability, or warranties of fitness for a particular purpose or merchantability, or warranties arising from course of dealing or usage of trade, are made regarding the information, recommendations, descriptions and safety notations contained herein. In no event will ABB be responsible to the user in contract, in tort (including negligence), strict liability or otherwise for any special, indirect, incidental or consequential damage or loss whatsoever including but not limited to damage to or loss of use of equipment, plant or power system, cost of capital, loss of profits or revenue, cost of replacement power, additional expenses in the use of existing power facilities, or claims against the user by its customers resulting from the use of information, recommendations, descriptions and safety notations contained herein

## 10. APPENDIX A – TORQUE REQUIREMENTS FOR SAE GRADE 5 STEEL HARDWARE

The table below applies to SAE Grade-5 unlubricated steel hardware into unlubricated, threaded steel material unless otherwise stated. Torque hardware within the maximum/minimum tolerance.

### SAE GRADE 5 STEEL HARDWARE

Hardware Size (inch.)	Torque Value
<b>1/4-20</b> Taptite - (for material thickness <u>0.104"</u> )	11 ft.lb- Max <b>Target = 10 ft-lbs</b> 8 ft.lb- Min
<b>1/4-20</b> Taptite - (for material thickness <u>0.119"</u> )	16 ft.lb- Max <b>Target = 15 ft-lbs</b> 13 ft.lb - Min
<b>5/16-18</b> (hex head)	20 ft.lb -Max <b>Target = 19 ft-lbs</b> 17 ft.lb – Min
<b>3/8-16</b> hex bolt	35 ft.lb -Max <b>Target = 30 ft-lbs</b> 15 ft.lb - Min
<b>3/8-16</b> flange bolt- (for polyester stand-off insulator)	35 ft.lb -Max <b>Target = 30 ft-lbs</b> 15 ft.lb - Min
<b>3/8-16</b> steel threaded stud- (CT mtg)	20 ft.lb -Max <b>Target = 19 ft-lbs</b> 18 ft.lb – Min
<b>3/8-16</b> fiberglass threaded stud- ( CT mtg)	12 ft.lb -Max <b>Target = 11 ft-lbs</b> 10 ft.lb - Min
<b>1/2-13</b> hex bolt	45 ft.lb - Max <b>Target = 40 ft-lbs</b> 30 ft.lb - Min
<b>5/8-11</b> hex bolt- (for polyester stand-off insulator)	40 ft.lb - Max <b>Target = 38 ft-lbs</b> 35 ft.lb - Min



## REVISION HISTORY

Rev.	Page	Change Description	Date / Initial
C	all	Update and rebrand	Oct 2017/DE
B	all	Update	Oct 2016/DE
A	all	Update	Jul 2015/DE

---

# Contacts

**ABB Inc.**

**Medium Voltage**

655 Century Point

Lake Mary, Florida 32746

Phone: +1 407 732 2000 ext. 5

+1 800 929 7947 ext. 5

[Customer.service.group@us.abb.com](mailto:Customer.service.group@us.abb.com)

[www.abb.com/mediumvoltage](http://www.abb.com/mediumvoltage)